

www.hatcocorp.com

Register Online!  
(see page 2)



## Portable Lamp Warmer LW Series

# Installation and Operating Manual

P/N 07.04.277.00

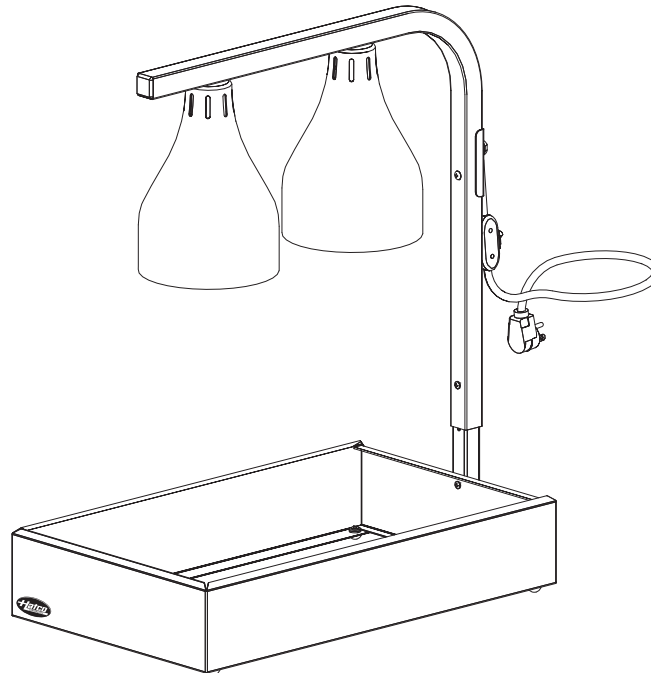

### **⚠ WARNING**

Do not operate this equipment unless you have read and understood the contents of this manual! Failure to follow the instructions contained in this manual may result in serious injury or death. This manual contains important safety information concerning the maintenance, use, and operation of this product. If you're unable to understand the contents of this manual, please bring it to the attention of your supervisor. Keep this manual in a safe location for future reference.

### **⚠ ADVERTENCIA**

No opere este equipo al menos que haya leído y comprendido el contenido de este manual! Cualquier falla en el seguimiento de las instrucciones contenidas en este manual puede resultar en un serio lesión o muerte. Este manual contiene importante información sobre seguridad concerniente al mantenimiento, uso y operación de este producto. Si usted no puede entender el contenido de este manual por favor pregunte a su supervisor. Almacenar este manual en una localización segura para la referencia futura.

### **⚠ AVERTISSEMENT**

Ne pas utiliser cet équipement sans avoir lu et compris le contenu de ce manuel ! Le non-respect des instructions contenues dans ce manuel peut entraîner de graves blessures ou la mort. Ce manuel contient des informations importantes concernant l'entretien, l'utilisation et le fonctionnement de ce produit. Si vous ne comprenez pas le contenu de ce manuel, veuillez le signaler à votre supérieur. Conservez ce manuel dans un endroit sûr pour pouvoir vous y référer plus tard.

# CONTENTS

<b>Important Owner Information</b> .....	<b>2</b>	<b>Operation</b> .....	<b>7</b>
<b>Introduction</b> .....	<b>2</b>	General .....	7
<b>Important Safety Information</b> .....	<b>3</b>	<b>Maintenance</b> .....	<b>8</b>
<b>Model Description</b> .....	<b>4</b>	General .....	8
<b>Model Designation</b> .....	<b>4</b>	Daily Cleaning.....	8
<b>Specifications</b> .....	<b>5</b>	Replacing a Heat Bulb .....	8
Plug Configuration.....	5	<b>Troubleshooting Guide</b> .....	<b>9</b>
Electrical Rating Chart .....	5	<b>Options and Accessories</b> .....	<b>10</b>
Dimensions .....	5	<b>Limited Warranty</b> .....	<b>11</b>
<b>Installation</b> .....	<b>6</b>	<b>Authorized Parts Distributors</b> .....	<b>Back Cover</b>
General .....	6		

## IMPORTANT OWNER INFORMATION

Record the model number, serial number (specification label located on the back of the unit), voltage, and purchase date of the unit in the spaces below. Please have this information available when calling Hatco for service assistance.

Model No. \_\_\_\_\_

Serial No. \_\_\_\_\_

Voltage \_\_\_\_\_

Date of Purchase \_\_\_\_\_

### Register your unit!

Completing online warranty registration will prevent delay in obtaining warranty coverage. Access the Hatco website at [www.hatcocorp.com](http://www.hatcocorp.com), select the *Parts & Service* pull-down menu, and click on "Warranty Registration".

Business Hours: 8:00 AM to 5:00 PM  
Central Standard Time (C.S.T.)  
  
(Summer Hours: June to September –  
8:00 AM to 5:00 PM C.S.T.  
Monday through Thursday  
8:00 AM to 2:30 PM C.S.T. Friday)

Telephone: (800) 558-0607; (414) 671-6350

E-mail: [partsandservice@hatcocorp.com](mailto:partsandservice@hatcocorp.com)

Fax: (800) 690-2966 (Parts and Service)  
(414) 671-3976 (International)



24 Hour 7 Day Parts and Service Assistance available in the United States and Canada by calling (800) 558-0607.

Additional information can be found by visiting our web site at [www.hatcocorp.com](http://www.hatcocorp.com).

## INTRODUCTION

Hatco Portable Lamp Warmers are designed to hold your food products at serving temperatures without affecting quality. The specially designed stand keeps food holding pans above the countertop, providing insulation for extended holding times.

Portable Lamp Warmers are quality built to meet the demands of foodservice operations and provide years of trouble-free performance.

Hatco Portable Lamp Warmers are products of extensive research and field testing. The materials used were selected for maximum durability, attractive appearance, and optimum performance. Every unit is inspected and tested thoroughly prior to shipment.

This manual provides the installation, safety, and operating instructions for Portable Lamp Warmers. Hatco recommends all installation, operating, and safety instructions appearing in this manual be read prior to installation or operation of a unit.

Safety information that appears in this manual is identified by the following signal word panels:



**WARNING** indicates a hazardous situation which, if not avoided, could result in death or serious injury.



**CAUTION** indicates a hazardous situation which, if not avoided, could result in minor or moderate injury.



**NOTICE** is used to address practices not related to personal injury.

## IMPORTANT SAFETY INFORMATION



Read the following important safety information before using this equipment to avoid serious injury or death and to avoid damage to equipment or property.

### WARNING

#### ELECTRIC SHOCK HAZARD:

- Plug unit into a properly grounded electrical receptacle of the correct voltage, size, and plug configuration. If plug and receptacle do not match, contact a qualified electrician to determine and install proper voltage and size electrical receptacle.
- Turn OFF power switch, unplug power cord, and allow unit to cool before performing any cleaning, adjustments, or maintenance.
- Unit is not weatherproof. Locate unit indoors where ambient air temperature is a minimum of 70°F (21°C).
- DO NOT submerge or saturate with water. Unit is not waterproof. Do not operate if unit has been submerged or saturated with water.
- Do not steam clean or use excessive water on unit.
- This unit is not “jet-proof” construction. Do not use jet-clean spray to clean this unit.
- Do not pull unit by power cord.
- Discontinue use if power cord is frayed or worn.
- Do not attempt to repair or replace a damaged power cord. Cord must be replaced by Hatco, an Authorized Hatco Service Agent, or a person with similar qualifications.
- This unit must be serviced by qualified personnel only. Service by unqualified personnel may lead to electric shock or burn.
- Use only Genuine Hatco Replacement Parts when service is required. Failure to use Genuine Hatco Replacement Parts will void all warranties and may subject operators of the equipment to hazardous electrical voltage, resulting in electrical shock or burn. Genuine Hatco Replacement Parts are specified to operate safely in the environments in which they are used. Some aftermarket or generic replacement parts do not have the characteristics that will allow them to operate safely in Hatco equipment.

**FIRE HAZARD:** Locate unit a minimum of 1” (25 mm) from combustible walls and materials. If safe distances are not maintained, discoloration or combustion could occur.

### WARNING

Hatco Corporation is not responsible for the actual food product serving temperature. It is the responsibility of the user to ensure that the food product is held and served at a safe temperature.

Make sure all operators have been instructed on the safe and proper use of the unit.

This unit is not intended for use by children or persons with reduced physical, sensory, or mental capabilities. Ensure proper supervision of children and keep them away from unit.

This unit has no “user-serviceable” parts. If service is required on this unit, contact an Authorized Hatco Service Agent or contact the Hatco Service Department at 800-558-0607 or 414-671-6350; fax 800-690-2966; or International fax 414-671-3976.

### CAUTION

**BURN HAZARD:** Some exterior surfaces on unit will get hot. Use caution when touching these areas.

Locate unit at the proper counter height in an area that is convenient for use. Location should be level and strong enough to support weight of unit and contents.

### NOTICE

Damage to any countertop material caused by heat generated from Hatco equipment is not covered under the Hatco warranty. Contact the manufacturer of the countertop material for application information.

Use non-abrasive cleaners and cloths only. Abrasive cleaners and cloths could scratch finish of unit, marring its appearance and making it susceptible to soil accumulation.

Do not use ammonia-based cleaners on unit.

Clean unit daily to avoid malfunctions and maintain sanitary operation.

# MODEL DESCRIPTION

## All Models

The Portable Lamp Warmer is specially designed to give long lasting, trouble-free service. The warmer incorporates a specially designed stand that keeps food holding pans above the countertop, providing an effective insulation to prolong serving times.

Portable Lamp Warmers have powdercoated lamp shades and an adjustable stand that allows you to vary the height from 10-1/2"-16-1/2" (267-419 mm) above the product. The base holds full size and half-size pans (not included).

The unit comes with vented metal lamp shades with heavy duty sockets, two uncoated 250 watt bulbs, and a 6' (1829 mm) cord and plug with an in-line ON/OFF switch. The warmer is available in several powdercoated *Designer* colors.

*NOTE: Refer to the OPTIONS AND ACCESSORIES section in this manual for additional features.*

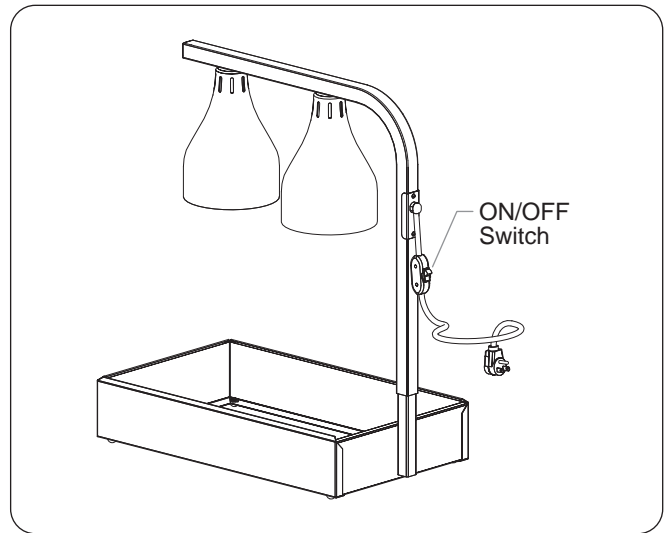

LW-2 Model

# MODEL DESIGNATION

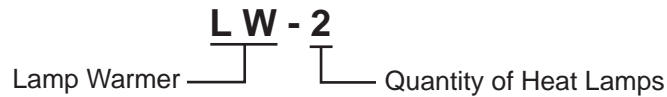

# SPECIFICATIONS

## Plug Configurations

Units are supplied from the factory with an electrical cord and plug installed. Plugs are supplied according to the applications.



**ELECTRIC SHOCK HAZARD:** Plug unit into a properly grounded electrical receptacle of correct voltage, size, and plug configuration. If plug and receptacle do not match, contact a qualified electrician to determine and install proper voltage and size electrical receptacle.

*NOTE:* Specification label located on the back of the unit. See label for serial number and verification of unit electrical information.

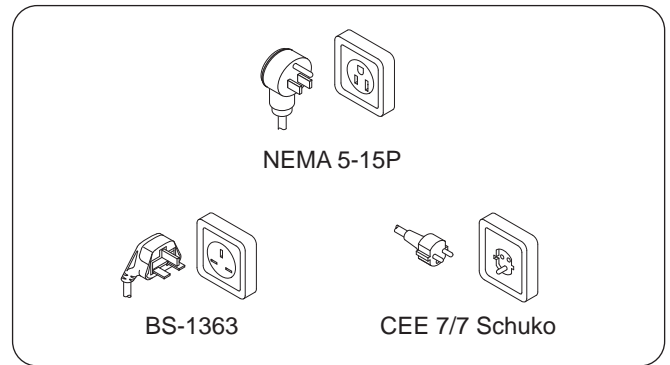

Plug Configurations

*NOTE:* Receptacles are not supplied by Hatco.

## Electrical Rating Chart

Model	Voltage	Watts	Amps	Plug Configuration	Shipping Weight
LW-2	120	500	4.2	NEMA 5-15P	18 lbs. (8 kg)
	220-230 (CE)	457-500	2.1-2.2	CEE 7/7 Schuko	18 lbs. (8 kg)
	230-240 (CE)	500-544	2.2-2.3	BS 1363	18 lbs. (8 kg)

The shaded areas contain electrical information for **International models only**.

## Dimensions

Model	Width (A)	Depth (B)	Height (C)	Footprint Width (D)	Footprint Depth (E)	Clearance (F)
LW-2	12-3/8" (314 mm)	21-5/8" (548 mm)	24-3/8-30-3/8" (618-770 mm)	12" (305 mm)	19-5/8" (498 mm)	10-1/2-16-1/2" (267-419 mm)

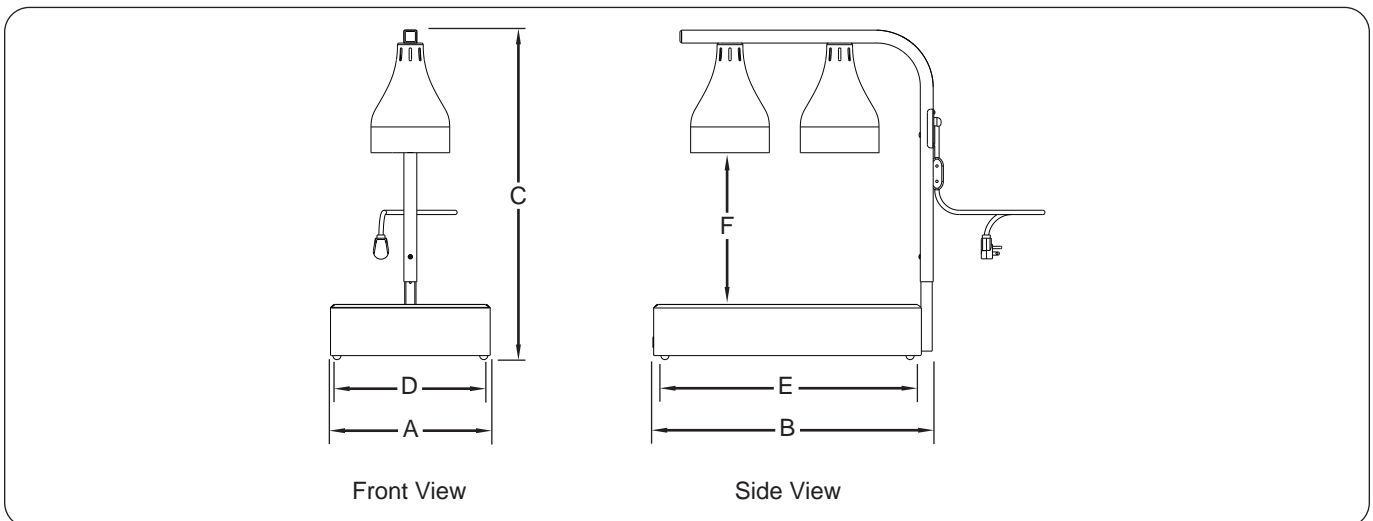

# INSTALLATION

## General

Use the following information and procedures to install a Portable Lamp Warmer.

### **WARNING**

#### ELECTRIC SHOCK HAZARD:

- Plug unit into a properly grounded electrical receptacle of the correct voltage, size, and plug configuration. If plug and receptacle do not match, contact a qualified electrician to determine and install proper voltage and size electrical receptacle.
- Unit is not weatherproof. Locate unit indoors where ambient air temperature is a minimum of 70°F (21°C).

#### FIRE HAZARD:

- Locate unit a minimum of 1" (25 mm) from combustible walls and materials. If safe distances are not maintained, discoloration or combustion could occur.

### **CAUTION**

Locate unit at the proper counter height in an area that is convenient for use. Location should be level and strong enough to support weight of unit and contents.

### **NOTICE**

Damage to any countertop material caused by heat generated from Hatco equipment is not covered under the Hatco warranty. Contact the manufacturer of the countertop material for application information.

1. Remove the unit from the carton.

*NOTE: To prevent delay in obtaining warranty coverage, complete online warranty registration. See the IMPORTANT OWNER INFORMATION section for details.*

2. Remove tape and protective packaging from all surfaces of the unit.
3. Place the unit in the desired location.
4. Place food pans into base of unit.
5. Adjust the lamps to the desired height.
  - a. Remove the height adjustment screw from the lamp post.
  - b. Move the lamp post to the desired position. There are four adjustment positions in increments of 2" (51 mm).
  - c. Align the adjustment screw with the hole at one of the four positions. Tighten securely.

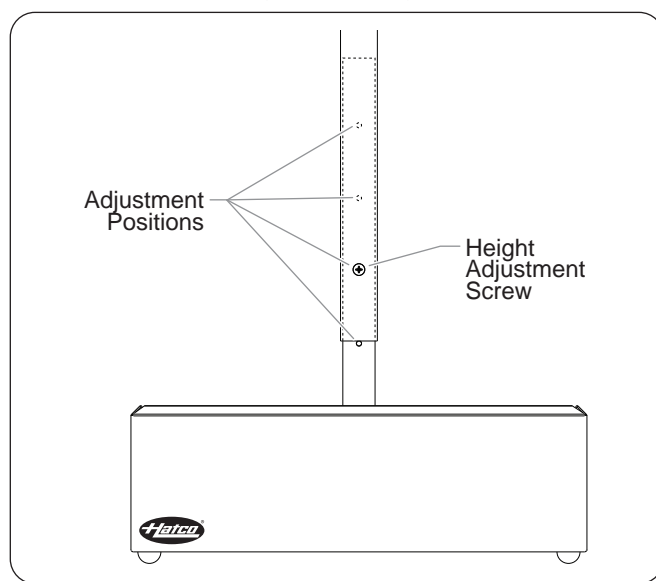

Lamp Height Adjustment

## General

Use the following procedure to operate a Portable Lamp Warmer.



**Read all safety messages in the Important Safety Information section before operating this equipment.**

**Hatco Corporation is not responsible for the actual food product serving temperature. It is the responsibility of the user to ensure that the food product is held and served at a safe temperature.**

## Startup

1. Plug the unit into a properly grounded electrical receptacle of the correct voltage, size, and plug configuration. See the SPECIFICATIONS section for details.
2. Move the ON/OFF switch to the ON position.
  - The ON/OFF switch is located on the electrical cord.



**BURN HAZARD: Some exterior surfaces on unit will get hot. Use caution when touching these areas.**

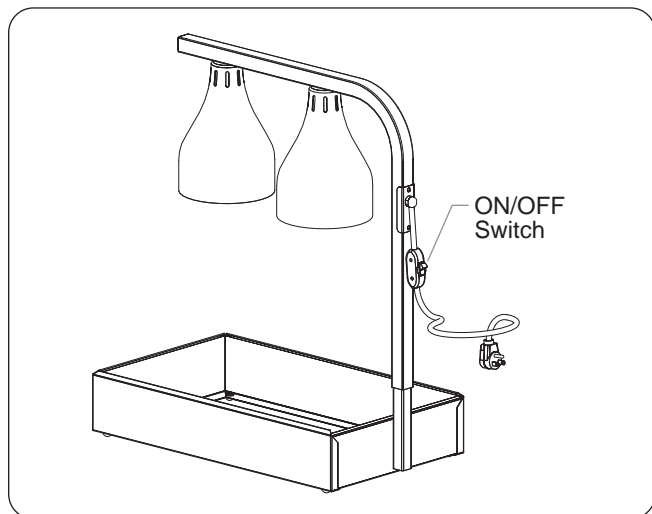

## Shutdown

1. Move the ON/OFF switch to the OFF position.
2. Perform the “Daily Cleaning” procedure in the MAINTENANCE section of this manual.

# MAINTENANCE

## General

Portable Lamp Warmers are designed for maximum durability and performance, with minimum maintenance.



### WARNING

#### ELECTRIC SHOCK HAZARD:

- Turn OFF power switch, unplug power cord, and allow unit to cool before performing any cleaning, adjustments, or maintenance.
- DO NOT submerge or saturate with water. Unit is not waterproof. Do not operate if unit has been submerged or saturated with water.
- Do not steam clean or use excessive water on unit.
- This unit is not “jet-proof” construction. Do not use jet-clean spray to clean this unit.

This unit has no “user-serviceable” parts. If service is required on this unit, contact an Authorized Hatco Service Agent or contact the Hatco Service Department at 800-558-0607 or 414-671-6350; fax 800-690-2966; or International fax 414-671-3976.

### NOTICE

Use non-abrasive cleaners and cloths only. Abrasive cleaners and cloths could scratch finish of unit, marring its appearance and making it susceptible to soil accumulation.

Do not use ammonia-based cleaners on unit.

Clean unit daily to avoid malfunctions and maintain sanitary operation.

## Daily Cleaning

To preserve the finish of the unit, it is recommended that all surfaces be wiped daily with a non-abrasive, damp cloth.

1. Move the ON/OFF switch to the OFF position and allow the unit to cool completely.
2. Wipe down the entire unit with a clean, non-abrasive, water-dampened cloth. Stubborn stains can be removed with a mild, non-abrasive cleanser.
3. Wipe dry the entire unit using a clean, non-abrasive cloth.

## Replacing a Heat Bulb

Each standard wattage Portable Lamp Warmer holds two infrared heat bulbs rated at 250 W.



### WARNING

Use only Genuine Hatco Replacement Parts when service is required. Failure to use Genuine Hatco Replacement Parts will void all warranties and may subject operators of the equipment to hazardous electrical voltage, resulting in electrical shock or burn. Genuine Hatco Replacement Parts are specified to operate safely in the environments in which they are used. Some aftermarket or generic replacement parts do not have the characteristics that will allow them to operate safely in Hatco equipment.

1. To replace a bulb, move the ON/OFF switch in the OFF position and allow the bulbs to cool completely.
2. Bulbs have a threaded base. Unscrew the heat bulb from the unit and replace with new bulb.

NOTE: Refer to the OPTIONS AND ACCESSORIES section for replacement heat bulbs available from Hatco.

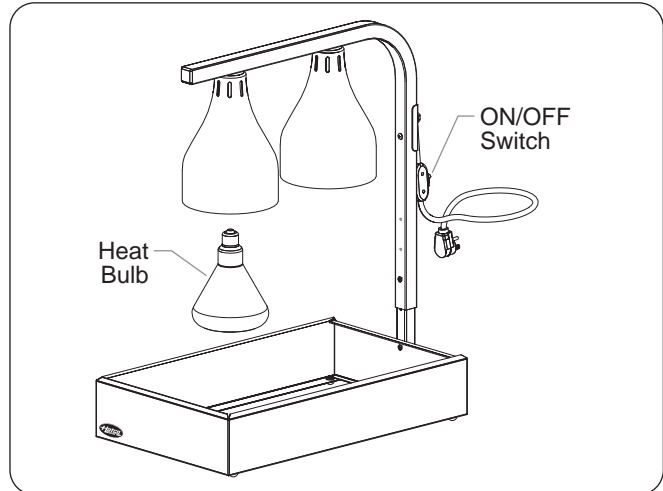

Replacing a Heat Bulb



# TROUBLESHOOTING GUIDE



This unit must be serviced by qualified personnel only. Service by unqualified personnel may lead to electric shock or burn.



**ELECTRIC SHOCK HAZARD:** Turn OFF power switch, unplug power cord, and allow unit to cool before performing any cleaning, adjustments, or maintenance.

Symptom	Probable Cause	Corrective Action
Unit is not working at all.	Unit not turned on.	Move ON/OFF switch to the ON position.
	ON/OFF switch is not functioning.	Contact Authorized Service Agent or Hatco for assistance.
	Bulbs have burned out.	Replace bulbs.
Unit is turned on but there is no light.	No power to unit.	Check circuit breaker and reset as necessary.
	Switch is defective.	Contact Authorized Service Agent or Hatco for assistance.
	Bulbs have burned out.	Replace bulbs.
Heat is inadequate.	Lights are too high above target area.	Lower unit, putting effective heat closer to target. See the INSTALLATION section for details.
	Excessive air movement around heating area.	Restrict or redirect air movement (i.e. air conditioning duct or exhaust fan) away from unit.
	Incorrect heat bulb wattage.	Verify heat bulb wattage and replace with the correct wattage bulb. <b>WARNING! DO NOT exceed maximum bulb wattage rating on specification plate.</b>
	Incorrect power supply (low).	Check power supply to unit, making sure it matches rating on the unit. If power supply is incorrect, change to match rating on unit.
Heat is excessive.	Lights are too close to target area.	Raise unit, putting effective heat farther from target area. See the INSTALLATION section for details.
	Heat bulb wattage too high.	Check bulb wattage and replace with correct wattage bulb.
	Voltage supply too high.	Check power supply to unit, making sure it matches rating on unit. If power supply is incorrect, change to match rating.

# OPTIONS AND ACCESSORIES

## Infrared Heat Bulbs

The following infrared heat bulbs are available for use in Hatco Portable Lamp Warmers.

120 V, 250 W, Clear, Coated	02.30.069.00
120 V, 250 W, Clear, Uncoated	02.30.071.00
120 V, 250 W, Red, Coated	02.30.068.00
120 V, 250 W, Red, Uncoated	02.30.070.00
240 V, 250 W, Clear, Coated	02.30.100.00
240 V, 250 W, Clear, Uncoated	02.30.083.00

## 5 Pleat French Fry Box Ribbon

A five pleat hardcoated french fry box ribbons is available as an accessory to hold french fry boxes.

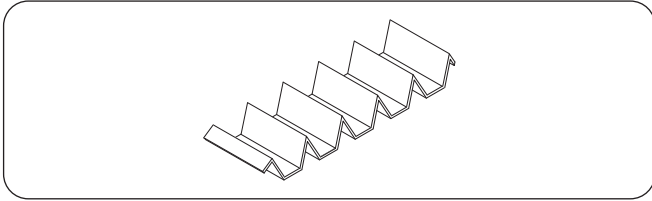

Five Pleat Fry Box Ribbon

## 8 Pleat French Fry Bag Ribbon

An eight pleat hardcoated french fry bag ribbon is available as an accessory to hold french fry bags.

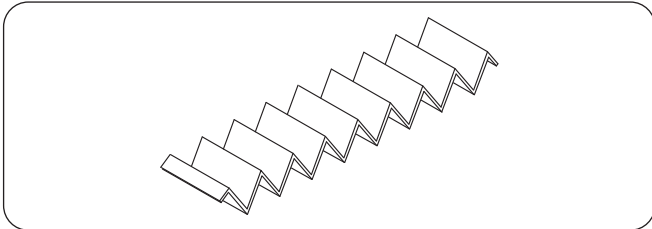

Eight Pleat Fry Bag Ribbon

## Food Holding Pans

The following stainless steel food holding pans are available for Portable Lamp Warmers.

<b>Full Size Pans</b> .....	12-3/4"W x 20-3/4"D x 4" H (324 mm x 527 mm x 102 mm)
<b>Half-Size Pans</b> .....	12-3/4"W x 10-3/8"D x 4" H (324 mm x 264 mm x 102 mm)
<b>Third-Size Pans</b> .....	12-3/4"W x 6-7/8"D x 4" H (324 mm x 175 mm x 102 mm)

# LIMITED WARRANTY

## 1. PRODUCT WARRANTY

Hatco warrants the products that it manufactures (the "Products") to be free from defects in materials and workmanship, under normal use and service, for a period of one (1) year from the date of purchase when installed and maintained in accordance with Hatco's written instructions or 18 months from the date of shipment from Hatco. Buyer must establish the Product's purchase date by registering the Product with Hatco or by other means satisfactory to Hatco in its sole discretion.

Hatco warrants the following Product components to be free from defects in materials and workmanship from the date of purchase (subject to the foregoing conditions) for the period(s) of time and on the conditions listed below:

- a) **One (1) Year Parts and Labor PLUS One (1) Additional Year Parts-Only Warranty:**
  - Conveyor Toaster Elements (metal sheathed)
  - Drawer Warmer Elements (metal sheathed)
  - Drawer Warmer Drawer Rollers and Slides
  - Strip Heater Elements (metal sheathed)
  - Display Warmer Elements (metal sheathed air heating)
  - Holding Cabinet Elements (metal sheathed air heating)
  - Heated Well Elements — HWB Series (metal sheathed)
- b) **One (1) Year Parts and Labor PLUS Four (4) Years Parts-Only Warranty on pro-rated terms that Hatco will explain at Buyer's request:**
  - 3CS and FR Tanks
- c) **One (1) Year Parts and Labor PLUS Nine (9) Years Parts-Only Warranty on:**
  - Electric Booster Heater Tanks
  - Gas Booster Heater Tanks
- d) **Ninety (90) Day Parts-Only Warranty:**
  - Replacement Parts

THE FOREGOING WARRANTIES ARE EXCLUSIVE AND IN LIEU OF ANY OTHER WARRANTY, EXPRESSED OR IMPLIED, INCLUDING BUT NOT LIMITED TO ANY IMPLIED WARRANTY OF MERCHANTABILITY OR FITNESS FOR A PARTICULAR PURPOSE OR PATENT OR OTHER INTELLECTUAL PROPERTY RIGHT INFRINGEMENT. Without limiting the generality of the foregoing, SUCH WARRANTIES DO NOT COVER: Coated incandescent light bulbs, fluorescent lights, heat lamp bulbs, coated halogen light bulbs, halogen heat lamp bulbs, xenon light bulbs, LED light tubes, glass components, and fuses; Product failure in booster tank, fin tube heat exchanger, or other water heating equipment caused by liming, sediment buildup, chemical attack, or freezing; or Product misuse, tampering or misapplication, improper installation, or application of improper voltage.

## 2. LIMITATION OF REMEDIES AND DAMAGES

Hatco's liability and Buyer's exclusive remedy hereunder will be limited solely, at Hatco's option, to repair or replacement using new or refurbished parts or Product by Hatco or a Hatco-authorized service agency (other than where Buyer is located outside of the United States, Canada, United Kingdom, or Australia, in which case Hatco's liability and Buyer's exclusive remedy hereunder will be limited solely to replacement of part under warranty) with respect to any claim made within the applicable warranty period referred to above. Hatco reserves the right to accept or reject any such claim in whole or in part. In the context of this Limited Warranty, "refurbished" means a part or Product that has been returned to its original specifications by Hatco or a Hatco-authorized service agency. Hatco will not accept the return of any Product without prior written approval from Hatco, and all such approved returns shall be made at Buyer's sole expense. HATCO WILL NOT BE LIABLE, UNDER ANY CIRCUMSTANCES, FOR CONSEQUENTIAL OR INCIDENTAL DAMAGES, INCLUDING BUT NOT LIMITED TO LABOR COSTS OR LOST PROFITS RESULTING FROM THE USE OF OR INABILITY TO USE THE PRODUCTS OR FROM THE PRODUCTS BEING INCORPORATED IN OR BECOMING A COMPONENT OF ANY OTHER PRODUCT OR GOODS.

# HATCO AUTHORIZED PARTS DISTRIBUTORS

## ALABAMA

Jones McLeod Appl. Svc.  
Birmingham 205-251-0159

## ARIZONA

Service Solutions Group  
Phoenix 602-234-2443

Byassee Equipment Co.  
Phoenix 602-252-0402

## CALIFORNIA

Industrial Electric  
Commercial Parts & Service, Inc.  
Huntington Beach 714-379-7100

Chapman Appl. Service  
San Diego 619-298-7106

P & D Appliance  
Commercial Parts & Service, Inc.  
S. San Francisco 650-635-1900

## COLORADO

Hawkins Commercial Appliance  
Englewood 303-781-5548

## FLORIDA

Whaley Foodservice Repair  
Jacksonville 904-725-7800

3Wire Nass Service Co., Inc.  
Orlando 407-425-2681

B.G.S.I.  
Pompano Beach 954-971-0456

Comm. Appliance Service  
Tampa 813-663-0313

## GEORGIA

TWC Services  
Mableton 770-438-9797

Heritage Service Group  
Norcross 866-388-9837

Southeastern Rest. Svc.  
Norcross 770-446-6177

## HAWAII

Burney's Comm. Service, Inc.  
Honolulu 808-848-1466

Food Equip Parts & Service  
Honolulu 808-847-4871

## ILLINOIS

Parts Town  
Lombard 708-865-7278

Eichenauer Elec. Service  
Decatur 217-429-4229

Midwest Elec. Appl. Service  
Elmhurst 630-279-8000

Cone's Repair Service  
Moline 309-797-5323

## INDIANA

GCS Service  
Indianapolis 317-545-9655

## IOWA

Electric Motor Service Co.  
Davenport 319-323-1823

Goodwin Tucker Group  
Des Moines 515-262-9308

## KENTUCKY

Service Solutions Group  
Lexington 859-254-8854

Service Solutions Group  
Louisville 502-451-5411

## LOUISIANA

Chandlers Parts & Service  
Baton Rouge 225-272-6620

## MARYLAND

Electric Motor Service  
Baltimore 410-467-8080

GCS Service  
Silver Spring 301-585-7550

## MASSACHUSETTS

Ace Service Co., Inc.  
Needham 781-449-4220

## MICHIGAN

Bildons Appliance Service  
Detroit 248-478-3320

Commercial Kitchen Service  
Bay City 517-893-4561

Midwest Food Equip. Service  
Grandville 616-261-2000

## MINNESOTA

GCS Service  
Plymouth 800-345-4221

## MISSOURI

General Parts  
Kansas City 816-421-5400

Commercial Kitchen Services  
St. Louis 314-890-0700

Kaemmerlen Parts & Service  
St. Louis 314-535-2222

## NEBRASKA

Anderson Electric  
Omaha 402-341-1414

## NEVADA

Burney's Commercial  
Las Vegas 702-736-0006

Hi. Tech Commercial Service  
N. Las Vegas 702-649-4616

## NEW JERSEY

Jay Hill Repair  
Fairfield 973-575-9145

Service Plus  
Flanders 973-691-6300

## NEW YORK

Acme American Repairs, Inc.  
Brooklyn 718-456-6544

Alpro Service Co.  
Brooklyn 718-386-2515

Appliance Installation  
Buffalo 716-884-7425

Duffy's Equipment Services, Inc.  
Buffalo 800-836-1014

3Wire Northern  
Plattsburgh 800-634-5005

Duffy's Equipment Services, Inc.  
Sauquoit 800-836-1014

J.B. Brady, Inc.  
Syracuse 315-422-9271

## NORTH CAROLINA

Authorized Appliance  
Charlotte 704-377-4501

## OHIO

Akron/Canton Comm. Svc. Inc.  
Akron 330-753-6635

Service Solutions Group  
Cincinnati 513-772-6600

Commercial Parts and Service  
Columbus 614-221-0057

Electrical Appl. Repair Service  
Brooklyn Heights 216-459-8700

E. A. Wichman Co.  
Toledo 419-385-9121

## OKLAHOMA

Hagar Rest. Service, Inc.  
Oklahoma City 405-235-2184

Krueger, Inc.  
Oklahoma City 405-528-8883

## OREGON

Ron's Service, Inc.  
Portland 503-624-0890

## PENNSYLVANIA

Elmer Schultz Services  
Philadelphia 215-627-5401

FAST Comm. Appl. Service  
Philadelphia 215-288-4800

Appliance Installation & Service  
Pittsburgh 412-809-0244

K & D Service Co.  
Harrisburg 717-236-9039

Electric Repair Co.  
Reading 610-376-5444

## RHODE ISLAND

Marshall Electric Co.  
Providence 401-331-1163

## SOUTH CAROLINA

Whaley Foodservice Repair  
W. Columbia 803-791-4420

## TENNESSEE

Camp Electric  
Memphis 901-527-7543

## TEXAS

GCS Service  
Fort Worth 800-433-1804

Armstrong Repair Service  
Houston 713-666-7100

Cooking Equipment Specialist  
Mesquite 888-866-9276

Refrigerated Specialist, Inc.  
Mesquite 888-866-9276

Commercial Kitchen Repair Co.  
San Antonio 210-735-2811

## UTAH

La Monica's Rest. Equip. Service  
Murray 801-263-3221

## VIRGINIA

Daubers  
Norfolk 757-855-4097

Daubers  
Springfield 703-866-3600

## WASHINGTON

3Wire Restaurant Appliance  
Seattle 800-207-3146

## WISCONSIN

A.S.C., Inc.  
Madison 608-246-3160

A.S.C., Inc.  
Milwaukee 414-543-6460

## CANADA

### ALBERTA

Key Food Equipment Service  
Edmonton 780-438-1690

### BRITISH COLUMBIA

Key Food Equipment Service  
Vancouver 604-433-4484

Key Food Equipment Service  
Victoria 250-920-4888

### MANITOBA

Air Rite, Inc.  
Winnipeg 204-895-2300

### NEW BRUNSWICK

EMR Services, Ltd.  
Moncton 506-855-4228

### ONTARIO

R.G. Henderson Ltd.  
Toronto 416-422-5580

Choquette - CKS, Inc.  
Ottawa 613-739-8458

### QUÉBEC

Choquette - CKS, Inc.  
Montreal 514-722-2000

Choquette - CKS, Inc.  
Québec City 418-681-3944

## UNITED KINGDOM

Marren Group  
Northants +44(0)1933 666233

HATCO CORPORATION  
P.O. Box 340500  
Milwaukee, WI 53234-0500 U.S.A.  
(800) 558-0607 (414) 671-6350  
Parts and Service Fax (800) 690-2966  
International Fax (414) 671-3976  
partsandservice@hatcocorp.com  
www.hatcocorp.com

**Register your unit online!**

See IMPORTANT OWNER INFORMATION  
section for details.