

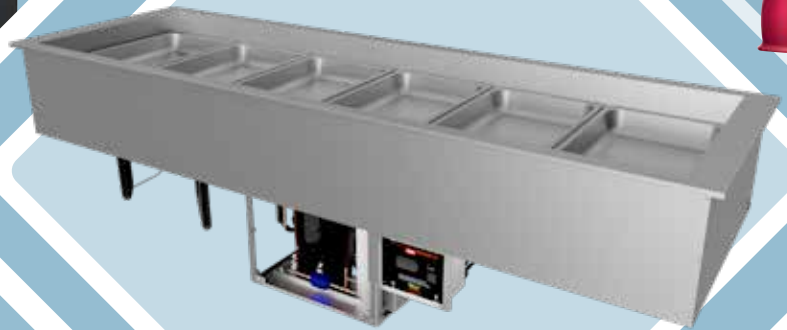

# FOODSERVICE EQUIPMENT PRICE LIST

DOMESTIC - July 1, 2024





People who serve,  
products that solve.®

Direct line equipment  
orders and Inquiries  
(414) 671-6350

#### How to Order

To ensure prompt and accurate  
processing of your order, please  
provide the following information:

1. Model number, voltage, Hertz and phase.
2. Specify options and accessories as required. Options are not retrofittable.
3. Consult factory when ordering equipment for special applications.
4. E-mail orders are acceptable and do not require confirmation.
5. See Resources section in back of book for more information.

**ALL WATT RATINGS ARE  
NOMINAL. ACTUAL WATTAGE  
MAY VARY. CONSULT FACTORY  
FOR MORE INFORMATION.**

**E-mail orders to:**  
equipsales@hatcocorp.com

**E-mail inquiries and requests to:**  
support@hatcocorp.com

Hatco Corporation  
P.O. Box 340500  
Milwaukee, WI 53234-0500  
Telephone: (414) 671-6350  
www.hatcocorp.com

## Who We Are

Since 1950, Hatco has been a leader in creating innovative ideas for the foodservice industry: bold innovations in equipment that improve efficiency, reliability and profits. Products are designed and built to handle the rugged demands of today's foodservice operations. Hatco is a company dedicated to exceptional customer service and quality engineered equipment offering maximum performance.

## We Pride Ourselves On Being Employee Owned

The company was started by Gordon and LaReine Hatch in 1950 and was led by their son, David, beginning in 1990. In 2004, Hatco Corporation began the journey of employee ownership and in 2007, a monumental event in Hatco history occurred: the employees assumed 100% ownership from David Hatch! Hatco still remains a family corporation - only now our family is larger. The employee owners are driven by the spirit of ownership and motivated by the empowerment of ownership.

## Equipment

Booster Water Heaters	Display Lights	Hot/Cold Wells	Portable Food Warmers
Built-In Shelves	Drawer Warmers	Hot Food Merchandisers	Refrigerated Wells
Built-In Warmers	Frost Tops	Hot Water Dispensers	Rethermalizers
Carving Stations	Fry Stations	Ice Wells	Rice Drawer Warmers
Cold Shelves	Griddles	Induction	Sanitizing Sink Heaters
Cold Wells	Heated Shelves	Light Cooking Equipment	Snack System
Commercial Toasters	Heated Wells	Locker Systems	Soup Stations
Crepe Makers	Holding & Display Cabinets	Nacho Chip Warmers	Strip Heaters
Decorative Lamps	Hot/Cold Shelves	Pizza Warmers	Waffle Makers

## Locations



**Milwaukee - Corporate Office**  
635 South 28th St. | Milwaukee, WI 53215  
414-671-6350



**Sturgeon Bay - Manufacturing Facility**  
208 East Deck Street | Sturgeon Bay, WI 54235  
920-743-5595



## Let's Get Social







# Table of Contents

<b>ORDER PICKUP STATIONS &amp; FOOD LOCKERS</b>	2-10
<b>WELLS</b>	11-59
<b>DECORATIVE LAMPS &amp; DISPLAY LIGHTS</b>	60-69
<b>STRIP HEATERS</b>	71-104
<b>FRY STATIONS</b>	105-110
<b>CARVING STATIONS</b>	111-113
<b>PORTABLES</b>	114-127
<b>BUILT-INS</b>	128-152

<b>DRAWER WARMERS</b>	153-158
<b>MERCHANDISERS</b>	159-181
<b>HOLDING &amp; DISPLAY CABINETS</b>	182-201
<b>TOASTERS</b>	202-208
<b>INDUCTION EQUIPMENT</b>	209-221
<b>LIGHT COOKING EQUIPMENT</b>	222-226
<b>WATER HEATING/SPECIALTY EQUIPMENT</b>	227-244

3CS	229
3CS2	230
AWD	228
C	235-236
CDW	157
CHW	19
CSBF, CSBFR, CSBFX	139-140
CSBFP	NEW 131
CSSB, CSSBR, CSSBX	136
CSSBF, CSSBFR, CSSBFX	137-138
CSSBFP	NEW 130
CSSBP	NEW 129
CSU, CSUR, CSUX	141-142
CSUP	NEW 132
CWB, CWB-S	28-30, 34
CWBP, CWBP-S	NEW 25-27
CWBR, CWBX, CWBR-S, CWBX-S	31-34
DCS	112
DHWBI, DHWBI-S	12-15
DL, DLL, DLH	NEW 61-67
F2G, F2GB	5-6
F2GP, F2GBP	7-8
FDWD-1-MN	194
FDWD	184, 187-188
FR	231
FR2	232
FS2HAC	201
FS3HAC	160-161
FSCD, FSCDH	179
FSD, FSDT	185-188
FSHAC, FSHACH	201
FSHC-5W, -7W	196
FSHC-6W	197
FSHC-7	198
FSHC-12W, -17W	199-200
FST-1-MN	194
FTB, FTB-S	37-38
FTBP, FTBP-S	NEW 35-36
FTBR, FTBR-S, FTBX, FTBX-S	39-40
FWM	223
GR2A, GR2AH	93, 95
GR2A-xxD, GR2AH-xxD	96-97
GR2AL, GR2AHL	94-95
GR2AL-xxD, GR2AHL-xxD	96-97
GR2BW	126-127
GR2S	121
GR2SDH, GR2SDS	168-169
GR3SDH, GR3SDS	173-174
GR3SDS-xxDCT, GR3SDS-xxTCT	175
GR5A, GR5AH	74, 76

GR5AL, GR5AHL	75-76
GR, GRH	78-79
GR-B	106-107
GRA, GRAH	77, 79
GRA-xxD, GRAH-xxD	80, 82
GRAL, GRAHL	78-79
GRAL-xxD, GRAHL-xxD	81-82
GRAIH, GRAIHL	90, 92
GRAIH-xxD, GRAIHL-xxD	91-92
GRAM, GRAML	83-84
GRAM-xxD	85, 87
GRAML-xxD	86-87
GRBW	126-127
GRCD, GRCDH	177-178
GRCMW	176
GRCSCD, GRCSCDH	113
GRFF, GRFFL, GRFFB, GRFFBL	106-107
GRFHS, GRFS	108-109
GRHD, GRHDH	180-181
GRHW	125
GRN, GRNH	88
GRNM	89
GRPWS	163-164
GRS2G	9
GRS	119-121
GRSB	150-151
GRSBF	152
GRSDH, GRSDS	166-167
GRSDS/H	165
GRSR	116
GRSS	122
GRSSB	148
GRSSR, GRSSRxx-DL77516	117-118
HBG	123
HGBG	149
HCSBF, HCSBFR, HCSBFX	146-147
HCSSB, HCSSBR, HCSSBX	143
HCSBFB, HCSBFR, HCSBFBX	144-145
HCWBI, HCWBIR, HCWBIX	20-21, 24
HDW	155-156
HDWTC	154
HDW-xR2	155-156
HGSM	124
HL	69
HL5	68
HRDW	158
HSBF-GL, -HC, -SS	133-135
HW	19
HWB, HWBL, HWBH	50-52, 58-59
HWB-xxQT, HWBI-xxQT	53-54, 58-59

HWBI, HWBL	41-43, 47
HWBI43	41, 44, 47
HWBI-S	45-47
HWBRN (UR)	55-56, 58-59
HWBRT (UR)	55-56, 58-59
HWBRN-xxQT (UR)	57-59
HWBRT-xxQT (UR)	57-59
HXXMH, HXXMS	170, 172
HZMH, HZMS	171-172
IHDCH	189-190
IRNG-BXC1	211
IRNG-HC1, -PC1, -PB1	212-216
IRNG-PC2F, -PC2S, -PB2	217-218
IWELB	NEW 210
IWRM-C1, -CD1, -B1	219-220
IWRM-UT	221
IWB, IWB-S	22-24
ITQ	203
LFST	192
LW	115
MC	234
MDW	193
MPP	4
MPP-xPT, -xHPT	NEW 3
MPWS	110
PDH	162
PFST	195
PMG	233
PSH	162
PWB, PWC	183
RHW	17
RMB	104
RMB2	103
RWM	225
S	237-238
SAL	226
SNACK	224
SWB, SWC	NEW 16
SW2	18
TK	208
TPT	204
TQ	206-207
TQ3	NEW 205
UGA, UGAH	98, 100
UGA-xxD, UGAH-xxD	99-100
UGAL, UGAHL	98, 100
UGAL-xxD, UGAHL-xxD	99-100
UGFF, UGFFL, UGFFB, UGFFBL	106-107
WFSB	191

# Order Pickup Stations & Food Lockers

*Restaurants • Cafés • Concessions  
Cafeterias • Convenience Stores*



**MPP-8PT** Operator side shown *pg. 3*



**MPP-8I** *pg. 4*



**F2G-34-A** in optional *Designer Navy Blue*  
(Customer side shown) *pg. 5*

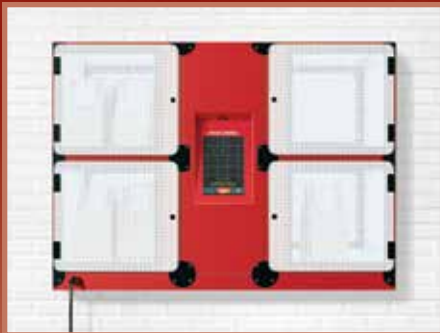

**F2GB-22-A** in standard *Designer Warm Red*  
(Operator side shown) *pg. 6*



**F2GP-14-C** in standard *Designer Warm Red*  
(Customer side shown) *pg. 7*



**GRS2G-3920-5** with optional side and back panels shown and **GRS2G-3920-2** *pg. 9*

## Pass-Through Pickup Pod™

Hatco's heated or ambient Pass-Through Pickup Pod™, propelled by Minnow™, helps automate customer and delivery pickups. As a pass-through unit, the operator can easily fill orders from the back of the house to help streamline the delivery process, and customers and delivery people simply access their reserved cubbies by scanning the QR code or using the embedded link sent via SMS. All of this is done without waiting in line or needing to ask for help from front of house staff.

- Available in either heated or ambient styles with eight unit pods
- Heated units are thermostatically controlled with an operational range of 140°F to 185°F
- Heated pods may also be operated in Ambient Mode
- Offers customers and delivery workers a touchless experience via their own devices with QR code and SMS messaging
- Energy-saving 5000K LED cubby lighting showcases food
- Each individual cubby is 13<sup>19</sup>/<sub>32</sub>" W x 20<sup>41</sup>/<sub>64</sub>" D x 14<sup>1</sup>/<sub>2</sub>" H
- The antimicrobial surfaces and touchless interface work in tandem to inhibit the spread of bacteria, mildew and germs
- Plug into a standard 120V outlet and units are ADA compliant
- Has rear door handles which allow for minimal contact and easy access
- Connects via Cellular, WiFi, or CAT-5/6



**MPP-8HPT**  
Operator side shown



**MPP-8HPT**  
Customer side shown

### PASS-THROUGH PICKUP POD

Model	Number of Lockers	Model Dimensions (W x D x H)	Internal Locker Dimensions (W x D x H)	Voltage	Watts	Amps	Plug	Approx. Ship Weight	List Price
<b>Ambient</b>									
MPP-8PT	8 Lockers	32 <sup>7</sup> / <sub>32</sub> " x 24" x 80 <sup>17</sup> / <sub>32</sub> "	13 <sup>19</sup> / <sub>32</sub> " x 20 <sup>41</sup> / <sub>64</sub> " x 14 <sup>1</sup> / <sub>2</sub> "	120	90	0.4	NEMA 5-15P	390 lbs.	<b>\$18274</b>
<b>Heated</b>									
MPP-8HPT	8 Lockers	32 <sup>7</sup> / <sub>32</sub> " x 24" x 80 <sup>17</sup> / <sub>32</sub> "	13 <sup>19</sup> / <sub>32</sub> " x 20 <sup>41</sup> / <sub>64</sub> " x 14 <sup>1</sup> / <sub>2</sub> "	120	1424	11.87	NEMA 5-15P	390 lbs.	<b>\$22626</b>

All Pass-Through Pickup Pod Models Feature:  
Cord Location: Operator side, bottom left.

### OPTIONS (available at time of purchase only)

Designer Colors – Charcoal standard –

BRONZE	Bronze	No Charge
PVCWHITE	White	No Charge

**NOTE:** SaaS (software as a service) fees are required for each unit. Contact factory for future details and requirements.

SaaS fees enables cloud connectivity, user interface and data analytics.

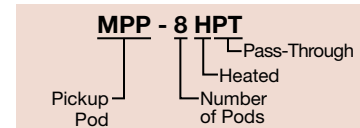
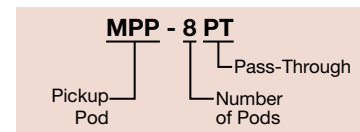



July 1, 2024

## Pickup Pod™

Hatco's Pickup Pod™ propelled by Minnow™, help automate customer and delivery pickups. A self-service, touchless pickup solution that reduces lobby/dining area congestion, eliminates pickup mistakes, reduces labor costs, and improves the takeout experience for all. Customers and delivery people simply access their reserved cubbies by scanning the QR code or using the embedded link sent via SMS. All without waiting in line or needing to ask for help from front of house staff. And unlike unsecure tables, The Hatco Pickup Pod keeps food fresh and secure until it's ready to be picked up.

- Pickup Pod offers customers and delivery workers a touchless experience via their own devices with QR code and SMS messaging.
- Touchless interface prevents spreading of germs
- Energy-saving 5000K LED cubby lighting showcases food
- Ambient individually insulated cubbies
- Configurable pick-up times help ensure food safety
- Antimicrobial surfaces inhibit the growth of bacteria mold and mildew
- Each cubby is a spacious 13<sup>3</sup>/<sub>4</sub>" W x 14<sup>1</sup>/<sub>2</sub>" D x 15" H
- Plugs into a standard 120V outlet
- Includes wall mounting bracket to keep unit stable (MPP-8I unit only)
- Connects via Cellular, WiFi, or CAT-5/6
- ADA compliant
- Customer notification sent via SMS Messaging or other methods via POS or App integrations (by others)
- Lily Pad base available to help stabilize units that cannot be fastened to the wall. Can be used in lieu of wall mounting brackets^ (MPP-8I unit only)

**NOTE:** SaaS (software as a service) fees are required for each unit. Contact factory for future details and requirements.

SaaS fees enables cloud connectivity, user interface and data analytics.



Optional touchscreen tablet

MPP-8I in standard Charcoal



### PICKUP POD

Model	Number of Lockers	Model Dimensions W x D x H	Internal Locker Dimensions (W x D x H)	Voltage	Watts	Amps	Plug	Approx. Ship Weight	List Price
MPP-8I	8 Lockers	31 <sup>7</sup> / <sub>8</sub> " x 16" x 77 <sup>3</sup> / <sub>4</sub> "	13 <sup>3</sup> / <sub>4</sub> " x 14 <sup>1</sup> / <sub>2</sub> " x 15"	120	90	.75	NEMA 5-15P	350 lbs.	\$12590

All Pickup Pod Models Feature:  
Cord Location: Center, back of unit.

#### OPTIONS (available at time of purchase only)

Designer Colors – Charcoal standard –

<b>BRONZE</b>	Bronze	No Charge
<b>PVC WHITE</b>	White	No Charge
<b>TOUCHSCREEN</b>	NEW Optional Touchscreen Tablet	\$2225

#### ACCESSORIES (available for purchase at any time for MPP-8I model only)

<b>MPP-PAD2-57</b> °	(Charcoal Color) 37.5" H x 25.5" W Lily Pad to stabilize free-standing units. Can only be used in lieu of wall mounting hardware.	\$481
<b>MPP-PAD2-58</b> °	(Bronze Color) 37.5" H x 25.5" W Lily Pad to stabilize free-standing units. Can only be used in lieu of wall mounting hardware.	481
<b>MPP-PAD2-61</b> °	(PVC White Color) 37.5" H x 25.5" W Lily Pad to stabilize free-standing units. Can only be used in lieu of wall mounting hardware.	481



MPP-8I Shown in optional PVC White with accessory MPP-PAD2-61°



MPP-PAD2-57°



MPP-PAD2-58°

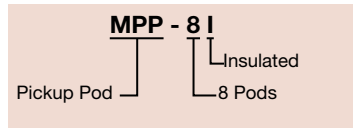

° Not UL approved component. In order to satisfy UL safety standards, the MPP-8I must be secured to a wall. The Lilypad may be used for stabilization in a freestanding installation, however, it will not satisfy the UL standard for safety in lieu of securing it to a wall. Please contact us if you have any questions.



## Flav-R 2-Go® Locker System

The Hatco Flav-R 2-Go® Countertop, Floor Mount, and Built-In Locker System conveniently holds multiple hot or ambient to-go food orders with quick and secure access. Customers and delivery drivers can arrive, access their specific locker and leave without waiting in line or disturbing the flow of business.

- Large 10" touchscreen for easy viewing (front and/or back)
- Lockers come preset to 150°F with a high temperature range up to 180°F
- Individual lockers can have the heat turned off for ambient storage
- Available in two locker depth sizes
- Available with pass-through or one-sided access (countertop or floor models only)
- Each locker has a timer that will hold prepared and packaged food for up to 45 minutes
- Customer side stays locked. When the access code is used, the door unlocks and LED lights flash in the appropriate locker



**F2G-3-A**  
in optional *Designer Black*  
(Customer side shown)

**NOTE:** This unit is intended for stationary indoor, commercial use only—NOT for mobile applications.

**F2G-24-A**  
in standard *Designer Warm Red*  
Red (Operator side shown)



### COUNTERTOP AND FLOOR MOUNT LOCKER SYSTEM

Model	Number of Lockers	Model Dimensions W x D x H	Internal Locker Dimensions (W x D x H)	Voltage	Watts	Amps	Plug	List Price
<b>Countertop</b>								
F2G-22-A	4 Lockers	43 <sup>5</sup> / <sub>8</sub> " x 14 <sup>3</sup> / <sub>4</sub> " x 31 <sup>3</sup> / <sub>4</sub> "	12" x 12" x 12"	120	423	3.8	NEMA 5-15P	<b>\$18202</b>
F2G-22-C	4 Lockers	43 <sup>5</sup> / <sub>8</sub> " x 23 <sup>1</sup> / <sub>4</sub> " x 31 <sup>3</sup> / <sub>4</sub> "	12" x 20 <sup>1</sup> / <sub>2</sub> " x 12"	120	551	4.8	NEMA 5-15P	<b>18396</b>
F2G-3-A	3 Lockers	61" x 14 <sup>3</sup> / <sub>4</sub> " x 16 <sup>5</sup> / <sub>8</sub> "	12" x 12" x 12"	120	321	2.9	NEMA 5-15P	<b>15104</b>
F2G-3-C	3 Lockers	61" x 23 <sup>1</sup> / <sub>4</sub> " x 16 <sup>5</sup> / <sub>8</sub> "	12" x 20 <sup>1</sup> / <sub>2</sub> " x 12"	120	417	3.7	NEMA 5-15P	<b>15583</b>
F2G-32-A	6 Lockers	61" x 14 <sup>3</sup> / <sub>4</sub> " x 31 <sup>3</sup> / <sub>4</sub> "	12" x 12" x 12"	120	627	5.5	NEMA 5-15P	<b>22953</b>
F2G-32-C	6 Lockers	61" x 23 <sup>1</sup> / <sub>4</sub> " x 31 <sup>3</sup> / <sub>4</sub> "	12" x 20 <sup>1</sup> / <sub>2</sub> " x 12"	120	819	7.1	NEMA 5-15P	<b>23848</b>
<b>Floor Mount</b>								
F2G-24-A	8 Lockers	45 <sup>5</sup> / <sub>8</sub> " x 14 <sup>3</sup> / <sub>8</sub> " x 71 <sup>1</sup> / <sub>4</sub> "	12" x 12" x 12"	120	831	7.3	NEMA 5-15P	<b>\$29061</b>
F2G-24-C	8 Lockers	45 <sup>5</sup> / <sub>8</sub> " x 22 <sup>5</sup> / <sub>8</sub> " x 71 <sup>1</sup> / <sub>4</sub> "	12" x 20 <sup>1</sup> / <sub>2</sub> " x 12"	120	1087	9.4	NEMA 5-15P	<b>31411</b>
F2G-34-A	12 Lockers	62 <sup>1</sup> / <sub>4</sub> " x 14 <sup>3</sup> / <sub>8</sub> " x 71 <sup>1</sup> / <sub>4</sub> "	12" x 12" x 12"	120	1239	10.8	NEMA 5-15P	<b>39838</b>
F2G-34-C	12 Lockers	62 <sup>1</sup> / <sub>4</sub> " x 22 <sup>5</sup> / <sub>8</sub> " x 71 <sup>1</sup> / <sub>4</sub> "	12" x 20 <sup>1</sup> / <sub>2</sub> " x 12"	120	1623	14.0	NEMA 5-15P*	<b>42161</b>

\* Canadian models use NEMA 5-20P.

**All Locker System Models Feature:**

**Cord Location:** Countertop Models: Operator side, bottom left.

**Floor Models:** Facing operator side, left side of unit bottom corner closest to operator side.

### OPTIONS AND ACCESSORIES – PAGE 6

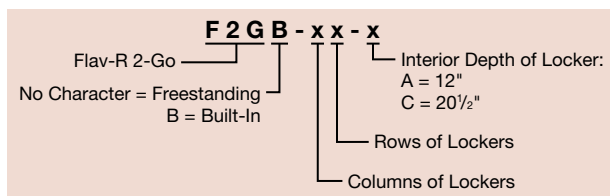



July 1, 2024

## Flav-R 2-Go® Locker System continued



**F2GB-22-A**  
in standard *Designer Warm Red* (Operator side shown)



**F2GB-22-A**  
in optional *Designer Black* (Customer side shown)

### BUILT-IN LOCKER SYSTEM

Model	Number of Lockers	Model Dimensions W x D x H	Internal Locker Dimensions (W x D x H)	Voltage	Watts	Amps	Plug	List Price
<b>Built-In</b>								
F2GB-22-A	4 Lockers	41 1/4" x 14 3/4" x 34 3/4"	12" x 12" x 12"	120	423	3.8	NEMA 5-15P	<b>\$18268</b>
F2GB-22-C	4 Lockers	41 1/4" x 23 1/4" x 34 3/4"	12" x 20 1/2" x 12"	120	551	4.8	NEMA 5-15P	<b>19067</b>
F2GB-23-A	6 Lockers	41 1/4" x 14 3/8" x 49 5/8"	12" x 12" x 12"	120	627	5.5	NEMA 5-15P	<b>23642</b>
F2GB-23-C	6 Lockers	41 1/4" x 22 7/8" x 49 5/8"	12" x 20 1/2" x 12"	120	819	7.1	NEMA 5-15P	<b>24468</b>
F2GB-3-A	3 Lockers	61" x 14 3/4" x 20"	12" x 12" x 12"	120	321	2.9	NEMA 5-15P	<b>15899</b>
F2GB-3-C	3 Lockers	61" x 23 1/4" x 20"	12" x 20 1/2" x 12"	120	417	3.7	NEMA 5-15P	<b>16602</b>
F2GB-32-A	6 Lockers	61" x 14 3/4" x 34 3/4"	12" x 12" x 12"	120	627	5.5	NEMA 5-15P	<b>23642</b>
F2GB-32-C	6 Lockers	61" x 23 1/4" x 34 3/4"	12" x 20 1/2" x 12"	120	819	7.1	NEMA 5-15P	<b>24468</b>
F2GB-33-A	9 Lockers	61" x 14 3/4" x 49 5/8"	12" x 12" x 12"	120	933	8.2	NEMA 5-15P	<b>31167</b>
F2GB-33-C	9 Lockers	61" x 23 1/4" x 49 5/8"	12" x 20 1/2" x 12"	120	1221	10.6	NEMA 5-15P	<b>32469</b>
F2GB-42-A	8 Lockers	77 3/4" x 14 3/4" x 34 3/4"	12" x 12" x 12"	120	831	7.3	NEMA 5-15P	<b>29108</b>
F2GB-42-C	8 Lockers	77 3/4" x 23 1/4" x 34 3/4"	12" x 20 1/2" x 12"	120	1087	9.4	NEMA 5-15P	<b>30482</b>
F2GB-43-A	12 Lockers	77 3/4" x 14 3/4" x 49 5/8"	12" x 12" x 12"	120	1239	10.8	NEMA 5-15P	<b>40890</b>
F2GB-43-C	12 Lockers	77 3/4" x 23 1/4" x 49 5/8"	12" x 20 1/2" x 12"	120	1623	14.0	NEMA 5-15P*	<b>41703</b>
F2GB-52-A	10 Lockers	94 5/8" x 14 3/4" x 34 3/4"	12" x 12" x 12"	120	1035	9.1	NEMA 5-15P	<b>35619</b>
F2GB-52-C	10 Lockers	94 5/8" x 23 1/4" x 34 3/4"	12" x 20 1/2" x 12"	120	1355	11.7	NEMA 5-15P	<b>36587</b>

\* Canadian models use NEMA 5-20P.

#### All Locker System Models Feature:

Cord Location: Built-In Models: Operator side, bottom left.

### OPTIONS (available at time of purchase only)

#### Designer Colors – Warm Red standard –

BLACK	Black	GRAY	Gray Granite	WHITE	White Granite	
NAVY	Navy Blue	GREEN	Hunter Green	COPPER	Antique Copper	<b>No Charge</b>
CNTRLPANEL_RIGHT		Right side control panel, in lieu of standard left side location (F2G-3, F2G-32, F2G-34, F2GB-3, F2GB-32, F2GB-52 and F2GB-33 models only)				<b>No Charge</b>

#### Back Panels – Creates a non-pass-through unit – will be same color as unit – Not available on Built-In models –

**COUNTERTOP:** The cord and power switch will move to the side of the unit, operators left, if right side is not selected at time of order. Subtract 15/16" to the depth and add 1 1/8" to width.

**FLOOR MOUNT:** The cord and power switch will move to the side of the unit, operators left, if right side is not selected at time of order. Subtract 15/16" to the depth and add 1 1/8" to width.

BPANEL3	Back panels in lieu of glass door for F2G-3 models	<b>\$ -480</b>
BPANEL4	Back panels in lieu of glass door for F2G-22 models	<b>-640</b>
BPANEL6	Back panels in lieu of glass door for F2G-32 models	<b>-960</b>
BPANEL8	Back panels in lieu of glass door for F2G-24 models	<b>-1280</b>
BPANEL12	Back panels in lieu of glass door for F2G-34 models	<b>-1920</b>
RGHTCRDLOCATION	Cord location moves to operator side, right lower corner, in lieu of standard operator side, left lower corner	<b>No Charge</b>
QR1	QR Code Reader for non-pass-through units. Must be combined with Back Panels	<b>1241</b>
QR2	QR Code Reader for pass-through units	<b>2482</b>

### ACCESSORIES (available for purchase at any time)

ANTI-TIPBRACKT	Wall Mount Bracket (mounting hardware not included) (Floor Mount models only)	<b>\$100</b>
----------------	---	--------------

### COLORS AND FINISHES – INSIDE BACK COVER

## Flav-R 2-Go® Pizza Locker System

The Hatco Flav-R 2-Go® Floor Mount, Built-In, and Countertop Pizza Locker System - designed specifically for your pick-up and third-party delivery needs, is capable of holding multiple orders of hot or ambient pizza with quick and secure access. By reducing congestion and allowing employees to focus on other functions, customers or delivery people can arrive, access their specific locker, and leave without waiting in line or disturbing the flow of other business.

- A great solution to handling pick-up, third-party delivery and to-go orders in a non-contact manner
- Individual lockers can have the heat turned off for ambient storage
- Each locker unit has a large 10" touchscreen on the operator side and on the customer side. The operator puts in the name and code. The customer receives the code, enters it on the customer side, and the appropriate door unlocks.
- As a pass-through unit, customer side stays locked. When the access code is used, the door unlocks and opens for 30 seconds
- Available in *Designer* colors



**F2GP-12-C**  
in standard *Designer* Warm Red (Customer side shown)



**F2GP-14-C**  
in standard *Designer* Warm Red (Customer side shown)

### COUNTERTOP AND FLOOR MOUNT PIZZA LOCKER SYSTEM

Model	Number of Lockers	Model Dimensions W x D x H	Internal Locker Dimensions (W x D x H)	Voltage	Watts	Amps	Plug	List Price
<b>Countertop</b>								
<b>F2GP-12-C</b>	4 Lockers	44 <sup>1</sup> / <sub>8</sub> " x 24 <sup>7</sup> / <sub>8</sub> " x 31 <sup>3</sup> / <sub>4</sub> "	20 <sup>7</sup> / <sub>8</sub> " x 20 <sup>1</sup> / <sub>2</sub> " x 4 <sup>29</sup> / <sub>32</sub> "	120	536	4.7	NEMA 5-15P	<b>\$23581</b>
<b>F2GP-21-C</b>	4 Lockers	77 <sup>7</sup> / <sub>8</sub> " x 24 <sup>7</sup> / <sub>8</sub> " x 16 <sup>7</sup> / <sub>8</sub> "	20 <sup>7</sup> / <sub>8</sub> " x 20 <sup>1</sup> / <sub>2</sub> " x 4 <sup>29</sup> / <sub>32</sub> "	120	536	4.7	NEMA 5-15P	<b>23581</b>
<b>F2GP-22-C</b>	8 Lockers	77 <sup>3</sup> / <sub>4</sub> " x 24 <sup>7</sup> / <sub>8</sub> " x 31 <sup>3</sup> / <sub>4</sub> "	20 <sup>7</sup> / <sub>8</sub> " x 20 <sup>1</sup> / <sub>2</sub> " x 4 <sup>29</sup> / <sub>32</sub> "	120	1057	9.2	NEMA 5-15P	<b>38112</b>
<b>Floor Mount</b>								
<b>F2GP-14-C</b>	8 Lockers	44 <sup>1</sup> / <sub>8</sub> " x 24 <sup>7</sup> / <sub>8</sub> " x 71 <sup>1</sup> / <sub>4</sub> "	20 <sup>7</sup> / <sub>8</sub> " x 20 <sup>1</sup> / <sub>2</sub> " x 4 <sup>29</sup> / <sub>32</sub> "	120	1057	9.2	NEMA 5-15P	<b>\$39793</b>

**All Pizza Locker System Models Feature:**

Cord Location: Countertop Models: Operator side, right corner.  
Floor Models: Operator side, right corner.

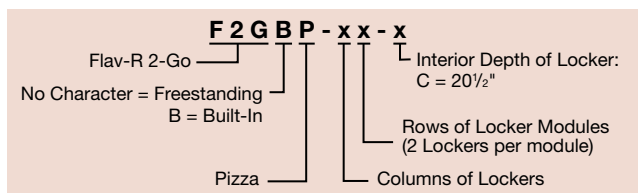



July 1, 2024

## Flav-R 2-Go® Pizza Locker System continued



**F2GBP-12-C**  
in standard  
*Designer*  
Warm Red  
(Customer  
side shown)

### BUILT-IN PIZZA LOCKER SYSTEM

Model	Number of Lockers	Model Dimensions W x D x H	Internal Locker Dimensions (W x D x H)	Voltage	Watts	Amps	Plug	List Price
<b>Built-In</b>								
<b>F2GBP-12-C</b>	4 Lockers	44 <sup>1</sup> / <sub>8</sub> " x 24 <sup>7</sup> / <sub>8</sub> " x 34 <sup>3</sup> / <sub>4</sub> "	20 <sup>7</sup> / <sub>8</sub> " x 20 <sup>1</sup> / <sub>2</sub> " x 4 <sup>29</sup> / <sub>32</sub> "	120	536	4.7	NEMA 5-15P	<b>\$25291</b>
<b>F2GBP-14-C</b>	8 Lockers	44 <sup>1</sup> / <sub>8</sub> " x 24 <sup>7</sup> / <sub>8</sub> " x 64 <sup>3</sup> / <sub>8</sub> "	20 <sup>7</sup> / <sub>8</sub> " x 20 <sup>1</sup> / <sub>2</sub> " x 4 <sup>29</sup> / <sub>32</sub> "	120	1057	9.2	NEMA 5-15P	<b>39327</b>
<b>F2GBP-21-C</b>	4 Lockers	77 <sup>3</sup> / <sub>4</sub> " x 24 <sup>7</sup> / <sub>8</sub> " x 19 <sup>15</sup> / <sub>16</sub> "	20 <sup>7</sup> / <sub>8</sub> " x 20 <sup>1</sup> / <sub>2</sub> " x 4 <sup>29</sup> / <sub>32</sub> "	120	536	4.7	NEMA 5-15P	<b>25291</b>
<b>F2GBP-22-C</b>	8 Lockers	77 <sup>3</sup> / <sub>4</sub> " x 24 <sup>7</sup> / <sub>8</sub> " x 34 <sup>3</sup> / <sub>4</sub> "	20 <sup>7</sup> / <sub>8</sub> " x 20 <sup>1</sup> / <sub>2</sub> " x 4 <sup>29</sup> / <sub>32</sub> "	120	1057	9.2	NEMA 5-15P	<b>39327</b>

**All Pizza Locker System Models Feature:**

Cord Location: Built-In Models: Operator side, bottom left corner.

### OPTIONS (available at time of purchase only)

**Designer Colors – Warm Red standard –**

<b>BLACK</b>	Black	<b>GRAY</b>	Gray Granite	<b>WHITE</b>	White Granite	
<b>NAVY</b>	Navy Blue	<b>GREEN</b>	Hunter Green	<b>COPPER</b>	Antique Copper	<b>No Charge</b>
<b>CNTRLPANEL_RIGHT</b>	Right side control panel, in lieu of standard left side location (F2GP-12-C and F2GBP-12-C models only)					<b>No Charge</b>
<b>RGHTCRDLOCATION</b>	Cord location moves to operator side, right lower corner, in lieu of standard operator side, left lower corner					<b>No Charge</b>
<b>QR2</b>	QR Code Reader for pass-through units					<b>2482</b>

### ACCESSORIES (available for purchase at any time)

<b>ANTI-TIPBRACKT</b>	Wall Mount Bracket (mounting hardware not included) (Floor Mount models only)	<b>\$100</b>
-----------------------	---	--------------

### COLORS AND FINISHES – INSIDE BACK COVER

**NOTE:** This unit is intended for stationary indoor, commercial use only—NOT for mobile applications.



## Glo-Ray 2-Go® Heated Shelves

The Hatco Glo-Ray 2-Go® Heated Shelves are designed specifically with your delivery and carry-out needs in mind. Capable of holding a great quantity of hot food items at optimum serving temperatures, the GRS2G models hold bags and boxes up to 30 minutes with a high temperature range of up to 200°F.

- Shelves are 20" deep and 39" wide, large enough for pizza boxes and bags, which will easily fit into the 13" clearance of each shelf
- Touchscreen control with digital read out indicates separate heat and timer for each shelf
- Standard units feature shelves with heated bases that are thermostatically-controlled and have a stainless steel frame
- The cord is recessed into the bottom shelf at a 45° angle, allowing the unit to be flush against either wall



### HEATED SHELVES

Model	Description	Dimensions W x D x H ‡	Voltage	Watts	Amps	Plug	Approx. Ship Weight	List Price
GRS2G-3920-2	2 heated shelves	43" x 20" x 21½"	120	704	5.6	NEMA 5-15P	150 lbs.	\$3760
GRS2G-3920-3	3 heated shelves	43" x 20" x 35¾"	120	1055	8.8	NEMA 5-15P	175 lbs.	4694
GRS2G-3920-4	4 heated shelves	43" x 20" x 50"	120	1406	11.7	NEMA 5-15P	200 lbs.	5624
GRS2G-3920-5	5 heated shelves	43" x 20" x 64¼"	120	1757	14.6	NEMA 5-15P*	225 lbs.	6581

‡ Height does not include 1¾" side wall mounting brackets.

\* Canadian models use NEMA 5-20P.

#### All Heated Shelf Models Feature:

Models shipped with: Side wall anchor brackets for improved stability, 6" adjustable flanged feet that can be bolted to the floor for additional stability and a 6" recessed cord and plug.

Cord Location: Server side, bottom right corner.

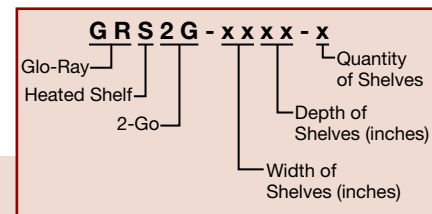

#### OPTIONS (available at time of purchase only)

Designer Colors – Non-standard colors are non-returnable – Stainless Steel standard –

RED	Warm Red	BLACK	Black	GRAY	Gray Granite	WHITE	White Granite	\$506
NAVY	Navy Blue	GREEN	Hunter Green	COPPER	Antique Copper			
CONTROL-GRS2G-R							Controls and permanent panel on customers right side in lieu of standard left side	No Charge

Side Panels – will be same color as unit –

SPANEL	GRS2G2	Side panels for a 2-shelf unit	\$ 98
	GRS2G3	Side panels for a 3-shelf unit	197
	GRS2G4	Side panels for a 4-shelf unit	295
	GRS2G5	Side panels for a 5-shelf unit	393

Back Panels – will be same color as unit –

BPANEL	GRS2G2	Back panels for a 2-shelf unit	\$ 85
	GRS2G3	Back panels for a 3-shelf unit	168
	GRS2G4	Back panels for a 4-shelf unit	252
	GRS2G5	Back panels for a 5-shelf unit	337

#### ACCESSORIES (available for purchase at any time)

4" LEGS	4" Adjustable Legs (for GRS2G-3920-2 and GRS2G-3920-3 models only)	Set of 4 \$66
---------	--	---------------

#### COLORS AND FINISHES – INSIDE BACK COVER

# Check out these other amazing Holding & Display Solutions!



**FS3HAC-2426** with optional square side cut-outs and top sign holder (signs not included) and **FS3HAC-3626** *pg. 160*



**PDH-55T** (bottom unit) with optional front glass panels below and **PSH-55D** (top unit). Both operator and customer sides shown. *pg. 162*



**PFST-2X** with standard stainless steel 8-shelf rack and **PFST-1XB** with standard Glossy White 8-shelf rack *pg. 195*

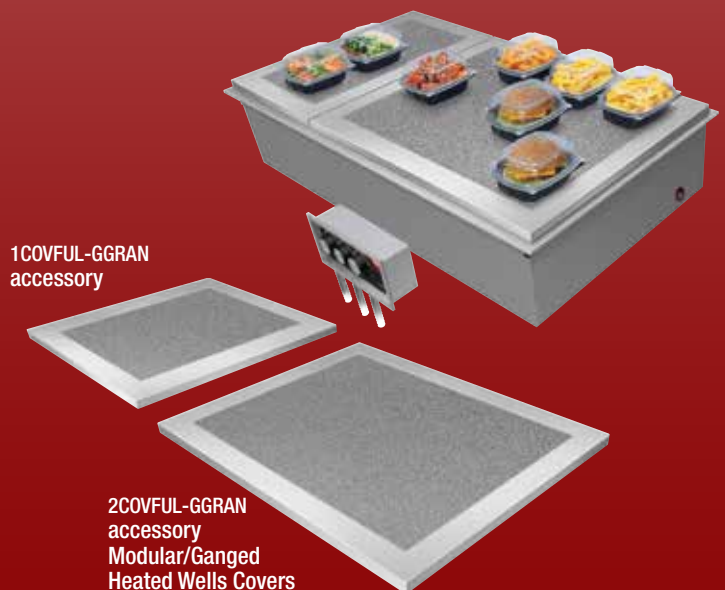

**2COVFUL-GGRAN** accessory  
Modular/Ganged  
Heated Wells Covers

**1COVFUL-GGRAN** accessory and **2COVFUL-GGRAN** shown with **HWBI-3** for reference *pg. 47*



# Wells

*Cafeterias • Buffets*  
*Convenience Stores • Supermarkets & Delis*  
*Restaurants & Cafés • Clubs & Bars*



**SWC-11QT** with accessory pan and lid *pg. 16*



**HW-43** with accessory pan support bars (food pans, ladles and lids not available) *pg. 19*



**IWB-6** with accessory food pan with two **HL5-60** (sneeze guards and bowls not available) *pg. 22*



**CWBP-6** with accessory food pans *pg. 26*



**CWB-S4** with optional **CWB-S4SLANT**, accessory pan support bars and food pans *pg. 30*



**FTBP-2** with accessory food pans *pg. 36*



**FTB-3** with accessory sheet pans *pg. 38*



**HWBI-3** with accessory heated well covers (one **1COVFUL-GGRAN** and one **2COVFUL-GGRAN**) *pg. 43, 47*



**SEE IN INDUCTION SECTION**

**IWELB-FUL-A** Drop-In Induction Dry Well with accessory food pans *pg. 210*



# Drop-In Modular/Ganged Dry Heated Wells Ordering Instructions

Wells

Cutaway of **DHWBI-2** with accessory food pans and pan support bars



### Please specify the following with each order:

- Desired Voltage** (single phase):  
 DHWBI-1, -2, -3: 120V (single controls only)  
 DHWBI-2, -3: 120/208-240V (single controls only)  
 DHWBI-4, -5, -6: 120/208-240V (single or split controls)
- Number of Modular/Ganged Dry Heated Wells Required:**  
 Standard Configuration: 1-, 2-, 3-, 4-, 5- or 6-pan as rectangular, full-size (12" x 20")
- Agency:**  
 A. UL, C-UL  
 B. UL-EPH (sanitary listing)

### 4. Control:

- Single Control Box (standard on all units)
- Split Controls Boxes (optional on 4-, 5-, 6-pan ganged units, not available in Canada)

### Options

- Bezel:**  
 A. Standard: 23<sup>5</sup>/<sub>8</sub>"  
 B. Oversized: 27" allows a deep bezel to match Hatco's Refrigerated Drop-In Wells in a counterop display  
 C. Factory installed gasket (see pg. 13)
- Attached Cord and Plug:**  
 DHWBI-1, -2, -3, -4

### Accessories for Modular/Ganged Heated Wells

- Pan Support Bars:** 12" or 20"
- Adapters** to convert Modular/Ganged units to hold 4- or 7-quart round pans
- Stainless Steel Pans:**  
 A. Third-size (12<sup>3</sup>/<sub>4</sub>"W x 6<sup>7</sup>/<sub>8</sub>"D x 2<sup>1</sup>/<sub>2</sub>"H)  
 B. Half-size (12<sup>3</sup>/<sub>4</sub>"W x 10<sup>3</sup>/<sub>8</sub>"D x 2<sup>1</sup>/<sub>2</sub>"H)  
 C. Full-size at 2<sup>1</sup>/<sub>2</sub>" deep (12<sup>3</sup>/<sub>4</sub>"W x 20<sup>3</sup>/<sub>4</sub>"D x 2<sup>1</sup>/<sub>2</sub>"H)  
 D. Full-size at 4" deep (12<sup>3</sup>/<sub>4</sub>"W x 20<sup>3</sup>/<sub>4</sub>"D x 4"H)  
 E. Full-size at 6" deep (12<sup>3</sup>/<sub>4</sub>"W x 20<sup>3</sup>/<sub>4</sub>"D x 6"H)

**ACCESSORIES – PAGES 58-59**

### DROP-IN MODULAR/GANGED DRY HEATED WELLS COUNTERTOP CUT-OUTS

Model	Minimum Width	Maximum Width**	Minimum Depth	Maximum Depth
DHWBI-1	14 <sup>1</sup> / <sub>8</sub> "	14 <sup>3</sup> / <sub>8</sub> "	22 <sup>1</sup> / <sub>4</sub> "	22 <sup>1</sup> / <sub>2</sub> "
DHWBI-2	28 <sup>1</sup> / <sub>8</sub> "	28 <sup>3</sup> / <sub>8</sub> "	22 <sup>1</sup> / <sub>4</sub> "	22 <sup>1</sup> / <sub>2</sub> "
DHWBI-3	42 <sup>1</sup> / <sub>8</sub> "	42 <sup>3</sup> / <sub>8</sub> "	22 <sup>1</sup> / <sub>4</sub> "	22 <sup>1</sup> / <sub>2</sub> "
DHWBI-4	56 <sup>1</sup> / <sub>8</sub> "	56 <sup>3</sup> / <sub>8</sub> "	22 <sup>1</sup> / <sub>4</sub> "	22 <sup>1</sup> / <sub>2</sub> "
DHWBI-5	70 <sup>1</sup> / <sub>8</sub> "	70 <sup>3</sup> / <sub>8</sub> "	22 <sup>1</sup> / <sub>4</sub> "	22 <sup>1</sup> / <sub>2</sub> "
DHWBI-6	84 <sup>1</sup> / <sub>8</sub> "	84 <sup>3</sup> / <sub>8</sub> "	22 <sup>1</sup> / <sub>4</sub> "	22 <sup>1</sup> / <sub>2</sub> "

\* Add 1/8" to Maximum Width when using EZ locking mount.



## Drop-In Modular/ Ganged Dry Heated Wells

The Hatco Modular/Ganged Dry Heated Wells are full-size units that are grouped together in a modular fashion to provide customers with a complete heated food offering within one piece of equipment for a clean integrated look. Unlike traditional steam tables, this unit provides dry convected heat and is specifically designed to obtain the most accurate and consistent holding temperatures. Also offers increased design flexibility and reduced installation costs due to the lack of plumbing restrictions.

- Full-size, insulated dry wells available in 1- to 6-ganged units
- Features compact individual thermostatic controls for each well and a separate On/Off switch to retain settings
- Uniform convected air flow consistently surrounds the food pan for efficient heat transfer
- Easy-to-service design for quick replacement or service of elements
- ¾" NPT (National Pipe Thread) brass drain provides easy cleanup should any food spills occur, and provides additional protection to the motor and fan from any liquids that might accumulate in the well
- 6' conduit is standard for convenient placement of controls



**DHWBI-2**  
with accessory (hotel)  
food pans and additional  
pan support bars



**DHWBI-1**

### DROP-IN MODULAR/GANGED DRY HEATED WELLS

Model	Dimensions (W x D x H)	Single Control Voltage	Split Control Voltage	Watts	Approx. Ship Weight	List Price
DHWBI-1	15½" x 23⅝" x 12⅛"	120V,	—	960	40 lbs.	\$ 3097
DHWBI-2	29½" x 23⅝" x 12⅛"	120, 120/208-240	—	1920	98 lbs.	5182
DHWBI-3	43½" x 23⅝" x 12⅛"	120, 120/208-240	—	2880	121 lbs.	7267
DHWBI-4	57½" x 23⅝" x 12⅛"	120/208-240	120, 120/208-240	3840	164 lbs.	9352
DHWBI-5	71½" x 23⅝" x 12⅛"	120/208-240	120	4804	196 lbs.	11437
DHWBI-6	85½" x 23⅝" x 12⅛"	120/208-240	120, 120/208-240	4800	233 lbs.	13522

All Drop-In Modular/Ganged Dry Heated Well Models Feature:

Models Shipped with: EZ locking hardware for installation, electronic temperature control, baffles and stainless steel bezel.

### OPTIONS (available at time of purchase only)

Attached Cord and Plug for DHWB-1, -2, -3, -4, single control and single phase only:

DHWBI-1 (120V is NEMA-5-15P)

DHWBI-2 (120V is NEMA-5-20P and 120/208-240V is NEMA L14-20P)

DHWBI-3 (120V is NEMA-5-30P and 120/208-240V is NEMA L14-20P)

DHWBI-4 (120/208-240V is NEMA L14-20P)

Attached Cords and Plugs for the following single phase / split control models only\*:

DHWBI-4 (120V are two NEMA 5-20P and 120/208-240V are two NEMA L14-20P)

DHWBI-5 (120V are one NEMA 5-20P / one NEMA 5-30P and 120/208-240V are two NEMA L14-20P)

DHWBI-6 (120V are two NEMA 5-30P and 120/208-240V are two NEMA L14-20P)

**NEW** DHWB-CORD \$158

OS-BEZEL27 27" D Bezel for Modular unit to match Hatco CWB models in a countertop display **No Charge**

#### Gasket Options –

BEZELGASKET-1	Factory installed for DHWB-1	\$ 121
BEZELGASKET-2	Factory installed for DHWB-2	121
BEZELGASKET-3	Factory installed for DHWB-3	158
BEZELGASKET-4	Factory installed for DHWB-4	158
BEZELGASKET-5	Factory installed for DHWB-5	170
BEZELGASKET-6	Factory installed for DHWB-6	170

\* Split Control configurations are not available in Canada

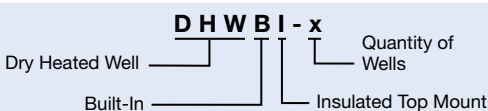

### Modular/Ganged Dry Heated Wells Controls\*

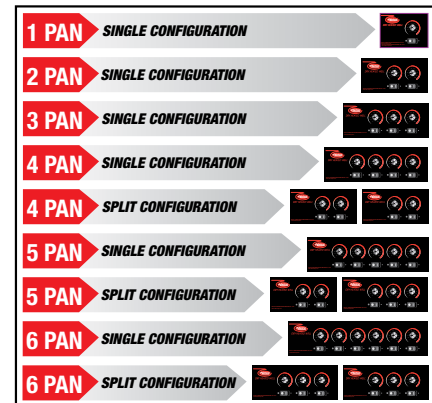

\* 4-, 5-, 6-pan units: Single control box is standard. If optional split control boxes are desired, it must be specified at time of order (for Canada, split control boxes not available).

COUNTERTOP CUT-OUT DIMENSIONS – PAGE 12  
ADDITIONAL ACCESSORIES – PAGES 58-59



# Drop-In Modular/Ganged Dry Slim Heated Wells Ordering Instructions

Wells

Cutaway of **DHWBI-S4**  
with accessory food pans and  
pan support bars

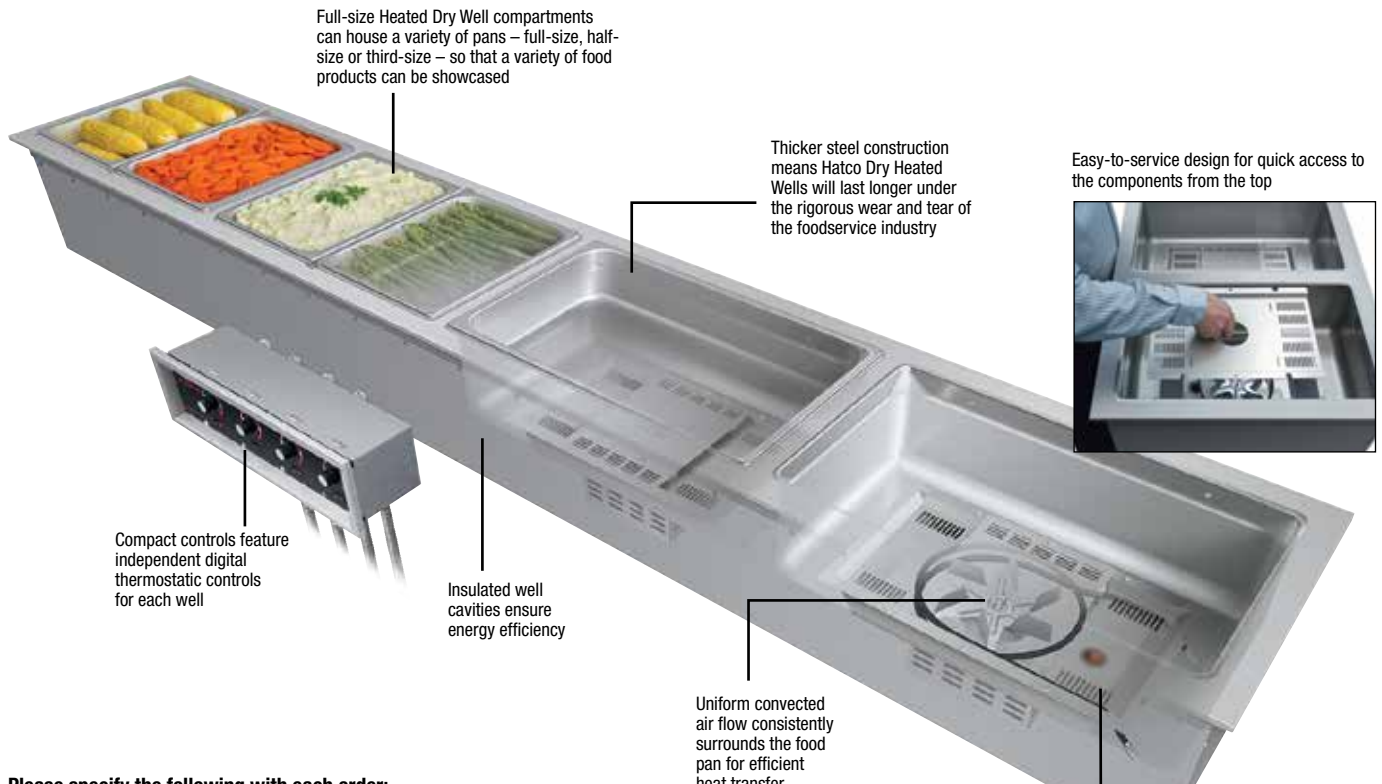

Full-size Heated Dry Well compartments can house a variety of pans – full-size, half-size or third-size – so that a variety of food products can be showcased

Thicker steel construction means Hatco Dry Heated Wells will last longer under the rigorous wear and tear of the foodservice industry

Easy-to-service design for quick access to the components from the top



Compact controls feature independent digital thermostatic controls for each well

Insulated well cavities ensure energy efficiency

Uniform convected air flow consistently surrounds the food pan for efficient heat transfer

Provides easy cleanup should any spill occur – provides additional protection to the motor and fan from any liquids that might accumulate in the well

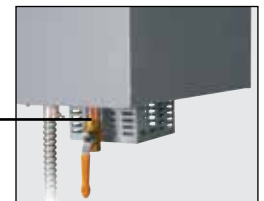

Underside view of the dry well showing where it leads to the 3/4" brass drain

**Please specify the following with each order:**

- 1. **Desired Voltage** (single phase):  
DHWBI-S2, -S3: 120V  
DHWBI-S2, -S3, -S4: 120/208-240V
- 2. **Number of Modular/Ganged Dry Heated Wells Required:** 2-, 3- or 4-pan  
Modular/Ganged Slim units are only offered as rectangular, full-size (12" x 20") but placed lengthwise
- 3. **Agency:**  
A. UL, C-UL  
B. UL-EPH (sanitary listing)

- 4. **Control**  
A. Single Control Box (standard on all units)  
B. Split Control Boxes (optional on 4-pan units, not available in Canada)

**Options**

- 1. **Bezel:**  
A. Standard: 15 5/8"  
B. Oversized: 19" allows a deep bezel to match Hatco's Refrigerated Slim Drop-In Wells in a countertop display  
C. Factory installed gasket (see pg. 15)
- 2. **Attached cord and plug:**  
DHWBI-S2, -S3, -S4

**Accessories for Modular/Ganged Heated Wells**

- 1. **Pan Support Bars:** 12" or 20"
- 2. **Adapters** to convert Modular/Ganged units to hold 4- or 7-quart round pans
- 3. **Stainless Steel Pans:**  
A. Third-size (12 3/4"W x 6 7/8"D x 2 1/2"H)  
B. Half-size (12 3/4"W x 10 3/8"D x 2 1/2"H)  
C. Full-size at 2 1/2" deep (12 3/4"W x 20 3/4"D x 2 1/2"H)  
D. Full-size at 4" deep (12 3/4"W x 20 3/4"D x 4"H)  
E. Full-size at 6" deep (12 3/4"W x 20 3/4"D x 6"H)

**ACCESSORIES – PAGES 58-59**

**DROP-IN MODULAR/GANGED DRY SLIM HEATED WELLS COUNTERTOP CUT-OUTS**

Model	Minimum Width	Maximum Width*	Minimum Depth	Maximum Depth
DHWBI-S2	43 1/8"	44 3/8"	14 1/32"	14 9/32"
DHWBI-S3	65 1/8"	66 3/8"	14 1/32"	14 9/32"
DHWBI-S4	87 1/8"	88 3/8"	14 1/32"	14 9/32"

\* Add 1/8" to Maximum Width when using EZ locking mount.

## Drop-In Modular/ Ganged Dry Slim Heated Wells

The Hatco Modular/Ganged Dry Slim Heated Wells are full-size units that are grouped together in a modular fashion but placed lengthwise. This provides customers with a complete heated food offering within easy reach. Unlike traditional steam tables, this unit provides dry convected heat and is specifically designed to obtain the most accurate and consistent holding temperatures. Also offers increased design flexibility and reduced installation costs due to the lack of plumbing restrictions.

- Full-size, insulated dry wells available in 2- to 4-ganged units
- Features compact individual thermostatic controls for each well and a separate On/Off switch to retain settings
- Uniform convected air flow consistently surrounds the food pan for efficient heat transfer
- Easy-to-service design for quick replacement or service of elements
- ¾" NPT (National Pipe Thread) brass drain provides easy cleanup should any food spills occur, and provides additional protection to the motor and fan from any liquids that might accumulate in the well
- 6' conduit is standard for convenient placement of controls

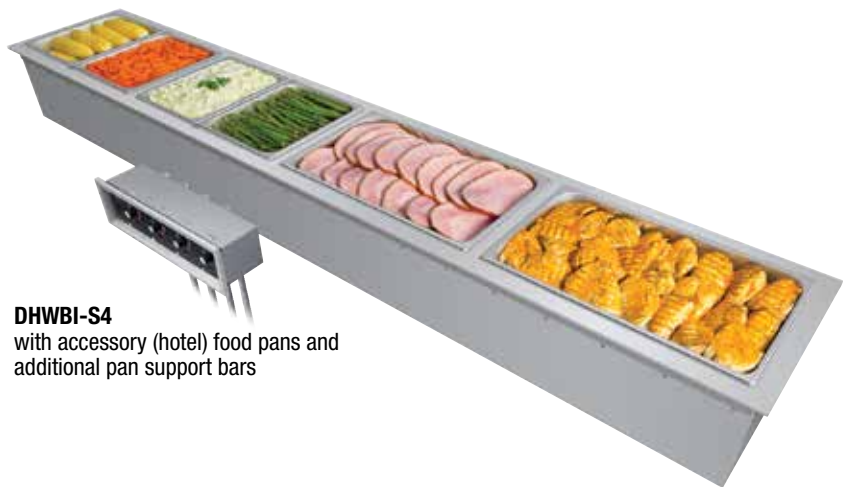

**DHWBI-S4**  
with accessory (hotel) food pans and additional pan support bars

### DROP-IN MODULAR/GANGED DRY SLIM HEATED WELLS

Model	Dimensions (W x D x H)	Single Control Voltage	Split Control Voltage	Watts	Approx. Ship Weight	List Price
<b>DHWBI-S2</b>	45½" x 15⅝" x 12⅞"	120V, 120/208-240	—	1920	94 lbs.	<b>\$5538</b>
<b>DHWBI-S3</b>	67½" x 15⅝" x 12⅞"	120V, 120/208-240	—	2880	146 lbs.	<b>7731</b>
<b>DHWBI-S4</b>	89½" x 15⅝" x 12⅞"	120/208-240	120V, 120/208-240	3840	177 lbs.	<b>9924</b>

All Drop-In Modular/Ganged Dry Slim Heated Well Models Feature:

Models Shipped with: EZ locking hardware for installation, electronic temperature control, baffles and stainless steel bezel.

#### OPTIONS (available at time of purchase only)

Attached Cord and Plug for single control and single phase only:  
 DHWBI-S2 (120V is NEMA-5-20P and 120/208-240V is NEMA L14-20P)  
 DHWBI-S3 (120V is NEMA-5-30P and 120/208-240V is NEMA L14-20P)  
 DHWBI-S4 (120/208-240V is NEMA L14-20P)

For Split Control Configurations:  
 Attached Cords and Plugs for the following single phase / split control models only\*:

DHWBI-S4 (120V are two NEMA 5-20P and 120/208-240V are two NEMA L14-20P)

**DHWBI-CORD** \$158

**OS-BEZEL19** 19" D Bezel for Modular unit to match Hatco CWB Slim models in a countertop display **No Charge**

#### Gasket Options –

<b>BEZELGASKET-2</b>	Factory installed for DHWBI-S2	<b>\$ 121</b>
<b>BEZELGASKET-3</b>	Factory installed for DHWBI-S3	<b>158</b>
<b>BEZELGASKET-4</b>	Factory installed for DHWBI-S4	<b>158</b>

#### Modular/Ganged Dry Heated Wells Controls\*

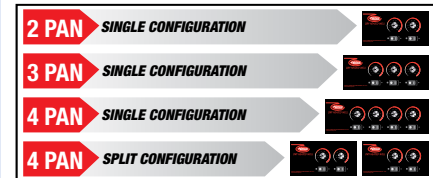

\*4-pan units: Single control box is standard. If optional split control boxes are desired, it must be specified at time of order (for Canada, split control boxes not available).



\* Split Control configurations are not available in Canada

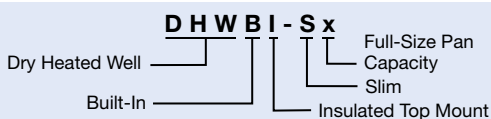

**COUNTERTOP CUT-OUT DIMENSIONS – PAGE 14**  
**ADDITIONAL ACCESSORIES – PAGES 58-59**

## Dry Soup Wells

Hatco's Dry Soup Wells offer a plumbing-free solution for rethermalizing or holding food at safe temperatures. Both the built-in and countertop units offer the same intuitive user interface, four customizable presets and six preset temperatures to make the Dry Soup Well a simple and effective solution.

- Gentle, even heating without the need for water
- Features an intuitive, interactive user interface
- Adjustable stir timers indicate when it's time to stir
- Automatically transfers from rethermalization to hold
- Features a screen lock to keep anyone else from tampering with the controls
- Includes pan with hinged lid



### DRY SOUP WELLS

Model	Item #	Color	Dimensions <sup>^</sup> (W x H)	Voltage	Watts	Amps	Plug	Ship Weight <sup>*</sup>	List Price
<b>Countertop</b>									
SWC-7QT	SWC7QTC515	Clear Coat	12 <sup>2</sup> / <sub>5</sub> " x 11 <sup>1</sup> / <sub>2</sub> "	120	425	3.5	NEMA 5-15P	14 lbs.	<b>\$1449</b>
SWC-7QT	SWC7QTB515	Bold Black	12 <sup>2</sup> / <sub>5</sub> " x 11 <sup>1</sup> / <sub>2</sub> "	120	425	3.5	NEMA 5-15P	14 lbs.	<b>1449</b>
SWC-11QT	SWC11QTC515	Clear Coat	14 <sup>2</sup> / <sub>5</sub> " x 11 <sup>1</sup> / <sub>2</sub> "	120	675	5.6	NEMA 5-15P	17 lbs.	<b>1490</b>
SWC-11QT	SWC11QTB515	Bold Black	14 <sup>2</sup> / <sub>5</sub> " x 11 <sup>1</sup> / <sub>2</sub> "	120	675	5.6	NEMA 5-15P	17 lbs.	<b>1490</b>
<b>Built-In</b>									
SWB-7QT	SWB7QT515	None	12 <sup>3</sup> / <sub>5</sub> " x 10 <sup>3</sup> / <sub>5</sub> "	120	425	3.5	NEMA 5-15P	14 lbs.	<b>\$1219</b>
SWB-11QT	SWB11QT515	None	10 <sup>3</sup> / <sub>5</sub> " x 10 <sup>3</sup> / <sub>5</sub> "	120	675	5.6	NEMA 5-15P	17 lbs.	<b>1417</b>

\* Shipping weight includes packaging.

<sup>^</sup> Dimensions only include the unit without the pan and lid.

**All Dry Soup Well Models Feature:**

Cord Location: Rear right bottom

### ACCESSORIES (available for purchase at any time)

**Pans –**

<b>7QT-PAN</b>	7-Quart Round Pan	<b>\$138</b>
<b>11QT-PAN</b>	11-Quart Round Pan	<b>152</b>

**Lids –**

<b>7QT-LID</b>	7-Quart Round, Hinged and Notched Lid	<b>\$101</b>
<b>7QT-LID-1</b>	7-Quart Round, Notched, Solid Lid	<b>72</b>
<b>11QT-LID</b>	11-Quart Round, Hinged and Notched Lid	<b>126</b>
<b>11QT-LID-1</b>	11-Quart Round, Notched, Solid Lid	<b>86</b>

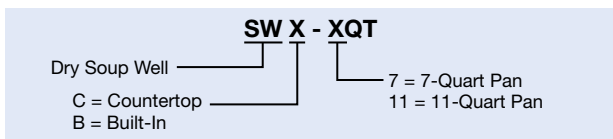



## Round Heated Wells

The multipurpose dry Heated Well from Hatco offers the flexibility of foodwarmers, soup kettles, Bain-Marie heaters, steamers and pasta cookers all in one! With a range of temperature settings, this unit can boil pasta and soup noodles, steam dim sum and warm and hold soups, curry, gravies and toppings at safe serving temperatures.

- Three temperature setpoints from 122°F to 212°F for warming, steaming and boiling
- Low power mode allows energy efficiency
- Single built-in model available (one 11-quart round pan)
- Freestanding units available as a single (one 11-quart round pan) or dual model (two 11-quart round pans) with individually-controlled pans



**RHW-1B** includes one RHW pan, lid and remote control (ladle not included)



**RHW-1** includes one RHW pan and lid



**RHW-2** includes two RHW pans and lids (lids not shown)

Wells

### FREESTANDING ROUND HEATED WELLS

Model	Dimensions W x D x H	kW	Voltage Single Phase	Plug	Approx. Ship Weight	List Price
<b>RHW-1</b>	14 <sup>7</sup> / <sub>8</sub> " x 13" x 14"	1.3	120	NEMA 5-15P	20 lbs.	<b>\$1034</b>
<b>RHW-2</b>	24 <sup>7</sup> / <sub>8</sub> " x 13" x 14"	2.0-2.7	208-240	NEMA 6-15P	36 lbs.	<b>1600</b>

**All Freestanding Round Models Feature:**

**Liquid Capacity:** RHW-1: 11-quart round pan (actual pan capacity: 6<sup>1</sup>/<sub>4</sub> quarts for boiling application or 8<sup>1</sup>/<sub>2</sub> quarts for warming application).

RHW-2: 2 x 11-quart round pans (actual pan capacity: 2 x 6<sup>1</sup>/<sub>4</sub> quarts for boiling application or 2 x 8<sup>1</sup>/<sub>2</sub> quarts for warming application).

**RHW-1 Shipped with:** One food holding pan and one pan lid.

**RHW-2 Shipped with:** Two food holding pans and two pan lids.

**Cord Location:** 72" cord and plug, back of unit.

### BUILT-IN ROUND HEATED WELL

Model	Dimensions W x D x H	kW	Voltage Single Phase	Plug	Approx. Ship Weight	List Price
<b>RHW-1B</b>	14 <sup>3</sup> / <sub>16</sub> " x 13" x 13 <sup>1</sup> / <sub>16</sub> "	1.3	120	NEMA 5-15P	21 lbs.	<b>\$966</b>

**All Built-In Round Models Feature:**

**Liquid Capacity:** 11-quart round pan (actual pan capacity: 6<sup>1</sup>/<sub>4</sub> quarts for boiling application or 8<sup>1</sup>/<sub>2</sub> quarts for warming application).

**RHW-1B Shipped with:** One food holding pan, one pan lid and remote control.

**Cord Location:** 56" cable from well to control box with a 6' cord and plug located at the back of the control box.

**Recommended Well Cut-Out Size:** 11<sup>1</sup>/<sub>4</sub>" diameter.

### ACCESSORIES (available for purchase at any time)

<b>RHW-11QT-LID-HG</b>	RHW Hinged Lid for 11-Quart Round Pan	<b>\$107</b>
<b>RHW-11QT-POT</b>	RHW 11-Quart Round Pan	<b>142</b>

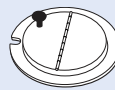

**RHW-11QT-LID-HG**  
Hinged lid for 11-quart round pan

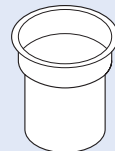

**RHW-11QT-POT**  
11-quart round pan

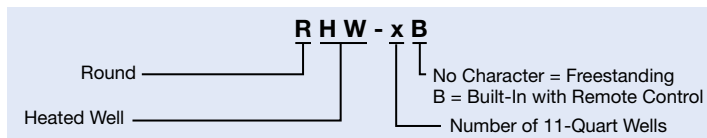



### Soup Stations

Hatco's Soup Station is designed to provide an attractive appearance while holding pre-heated soups at safe-serving temperatures – whether it's front of the house, self-serve kiosks or catering.

Heat is evenly distributed throughout the unit to hold foods at optimum temperatures, and the insulated stainless steel design provides easy maintenance and durable performance.

- Unit available to accommodate two 7-quart or two 11-quart round pans
- Stainless steel construction with insulation that provides easy maintenance and durable performance

- Infinite switch with indicator light on both ends of unit controls nearest well
- Convenient recessed handles
- Comes with 6' cord and plug attached



SW2-11QT



SW2-7QT in optional Designer color

### SOUP STATIONS

Model	Dimensions W x D x H	Voltage Single Phase	Watts	Plug	Approx. Ship Weight	List Price
SW2-7QT	25½" x 15¾" x 10¼"	120	750	NEMA 5-15P	34 lbs.	<b>\$1587</b>
SW2-11QT	25½" x 15¾" x 10¼"	120	750	NEMA 5-15P	53 lbs.	<b>1633</b>

#### All Soup Station Models Feature:

Models Shipped with: Two heating elements, indicator light, infinite switch and controls located at each end of unit.  
Cord Location: Back of unit.

### OPTIONS (available at time of purchase only)

#### Designer Color – Non-standard colors are non-returnable –

SS	Base unit in Stainless Steel (standard)	No Charge
BLACK	Base unit in Designer Black	\$226

#### Upper Shelf with LED Lights – (includes a Reversible Back that fits Magnetic Graphics [not included] or reverse for a Sign Holder to insert your custom signage) –

#### Non-standard colors are non-returnable –

SW2-US-LED	Stainless Steel (standard) – add 7/8" to depth, 16¼" to height	\$725
SW2-US-LED-BK	Designer Black – add 7/8" to depth, 16¼" to height	795



SW2-US-LED Upper shelf with LED lights and reversible back for magnetic graphics or reverse for a sign holder to insert your custom signage

### ACCESSORIES (available for purchase at any time)

#### Reversible Back – (fits Magnetic Graphics [not included] or reverse the back for a Sign Holder to insert your custom signage) – Non-standard colors are non-returnable –

SW2-BACK	Reversible Back (with posts) in Stainless Steel, graphic not included (add 13½" to height and 7/8" to depth)	\$316
SW2-BACK-BK	Reversible Back (with posts) in Designer Black, graphic not included (add 13½" to height and 7/8" to depth)	382

SW2-BACK Reversible back (with posts) in Stainless Steel, fits magnetic graphics (not included) or reverse the back for sign holder to insert your custom signage



Reversible back with backslash shown



Reversible back with signholder shown

#### SW2-4.5RAIL Cup rail accessory



#### Cup Rail –

SW2-4.5RAIL	Cup Rail in Stainless Steel (add 4½" to depth)	\$ 98
SW2-4.5RAIL-BK	Cup Rail in Designer Black (add 4½" to depth)	119

#### Magnetic Graphics (for Base and Reversible Back) –

SW2-BASEGRPHCS	Magnetic Base Graphics (covers 3 sides - front and both sides of Soup Station)	\$279
SW2-BACKSGRPHC	Magnetic Back Graphic (Backsplash Graphic Area: 23¼"W x 11¾"D)	138



SW2-BASEGRPHCS Three magnetic base graphic accessories (covers 3 sides of base)

SW2-BACKSGRPHC Magnetic reversible back accessory



### PAN AND LID ACCESSORIES – PAGE 58

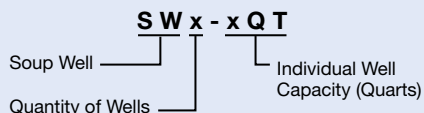

## Countertop Heated Wells

Providing versatility and reliability, Hatco Countertop Heated Wells hold food hot and fresh in either a wet or dry operation with an adjustable temperature control. The -FUL units can hold a full-size pan or three third-size pans, while the -43 units can hold a full-size pan with a third-size pan or four third-size pans. The HW series are hold only, while the CHW series are capable of rethermalizing a variety of foods as well as holding (cook and hold).

- Controls feature a separate lighted On/Off rocker switch and adjustable temperature dial
- May be used dry but performs best when used with water. Dry indicator light informs user to add water
- Thicker .8 mm stainless steel pan with a stainless steel housing (aluminized steel bottom)
- Pan edge offset to help keep condensation from dripping onto countertop surface



HW-FUL with accessory food pans and pan support bar



**CHW-43**  
with accessory food pans and pan support bar (single unit holding 1 full-size pan and 1 third-size pan)

Wells

### HOLD ONLY COUNTERTOPS – FULL-SIZE AND 4/3-SIZE

Model	Dimensions W x D x H	Voltage	Watts	Plug	Approx. Ship Weight	List Price
<b>Standard Watt</b>						
HW-FUL	14½" x 24" x 9¾"	120	1200	NEMA 5-15P	29 lbs.	<b>\$637</b>
HW-43	14½" x 31" x 9¾"	120	1200	NEMA 5-15P	33 lbs.	<b>799</b>

### COOK & HOLD COUNTERTOPS – FULL-SIZE AND 4/3-SIZE

Model	Dimensions W x D x H	Voltage	Watts	Plug	Approx. Ship Weight	List Price
<b>High Watt</b>						
CHW-FUL	14½" x 24" x 10¾"	120	1440	NEMA 5-15P	29 lbs.	<b>\$725</b>
CHW-43	14½" x 31" x 10¾"	120	1800	NEMA 5-15P NEMA 5-20P (Canada only)	35 lbs.	<b>839</b>

**All Countertop Heated Well Models Feature:**

**Voltage:** Single phase.

**Cord Location:** Bottom left corner on back of unit.

**Models Shipped with:** Stainless steel pan, stainless steel (aluminized stainless steel bottom) housing with a metal sheathed heating element, a power On/Off switch, a temperature control, a dry unit indicator light and a 6' cord with plug attached.

### ACCESSORIES (available for purchase at any time)

HW-2-7QT	Adapter to convert warmer to hold two 7-Quart Inserts (models HW-FUL, CHW-FUL only)	<b>\$ 98</b>
HW-3-4QT	Adapter to convert warmer to hold three 4-Quart Inserts (models HW-FUL, CHW-FUL only)	<b>98</b>
HW-2-11QT	Adapter to convert warmer to hold two 11-Quart Inserts (models HW-43, CHW-43 only)	<b>123</b>
HW-4-4QT	Adapter to convert warmer to hold four 4-Quart Inserts (models CHW-43, HW-FUL-43 series only)	<b>98</b>
HW12BAR	12" Pan Support for Countertop Wells	<b>21</b>
HW20BAR	20" Pan Support for Countertop Wells	<b>25</b>

### ADDITIONAL PAN AND LID ACCESSORIES – PAGES 58-59

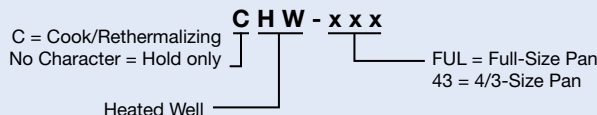

HW-4-4QT



## Drop-In Hot/Cold Wells

Whether it is breakfast in the morning or a salad bar at lunch, this well incorporates the legendary Hatco quality of both the hot and cold units into one.

- Accommodates full-size pans
- Cold Mode: Similar to Hatco's CWB Cold Well, including auto-defrost, easy serviceability, optimal insulation and efficient condenser. Includes cold mode pan supports
- Hot Mode: Utilizes the same time-tested FR2 Hydro-Heater (Bain Marie) with "free flow" technology for an efficient and safe operation with a longer life, and includes drain, auto-fill and hot mode frame for pan supports
- Simple controls for ease of use
- Adjustable set points to keep your particular food items at optimum temperatures
- Remote control box that can be mounted to a front counter for easy access (any vertical surface within approximately five feet)



**HCWB1-2DA** shown in **hot** mode with heated pan support bars (included), designed for easier handling of food pans



**HCWB1-2DA** shown in **cold** mode with cold pan support bars (included) and accessory food pans

### DROP-IN HOT/COLD WELLS

Model	Dimensions W x D x H	HP	Watts Hot Mode	Approx. Ship Weight	List Price			
					120/208V		120/240V	
					Single Phase	Three Phase	Single Phase	Three Phase
HCWB1-2DA	32" x 27" x 26 1/8"	1/5	3000	209 lbs.	<b>\$14114</b>	<b>\$15189</b>	—	<b>\$15189</b>
HCWB1-3DA	45" x 27" x 26 1/8"	1/5	3000	241 lbs.	<b>14551</b>	<b>15626</b>	—	<b>15626</b>
HCWB1-4DA	58" x 27" x 26 1/8"	1/3	4000	282 lbs.	<b>15180</b>	<b>16255</b>	<b>\$15180</b>	<b>16255</b>
HCWB1-5DA	71" x 27" x 26 1/8"	5/8	6000	351 lbs.	<b>17144</b>	<b>18219</b>	—	<b>18219</b>
HCWB1-6DA	84" x 27" x 26 1/8"	5/8	6000	358 lbs.	<b>18986</b>	<b>20061</b>	—	<b>20061</b>

All models utilize R-513A Refrigerant.

#### All Drop-In Hot/Cold Well Models Feature:

**Models Shipped with:** Electronic temperature control, pan support bars for full-size pans (one set each: hot and cold mode), Bain-Marie, low-water cut-off (LWCO), condensing unit, auto-defrost, sight glass, service valves and dryer. Consult factory for refrigerant specifications.

### OPTIONS (available at time of purchase only)

<b>EWC</b>	Additional Four Year Parts Only Warranty on the Compressor (HCWB1 and HCWB1R series only)	<b>\$200</b>
<b>Gasket Options –</b>		
<b>BEZELGASKET-2</b>	Factory installed for HCWB1-, HCWB1R- and HCWB1X-2DA	<b>\$ 93</b>
<b>BEZELGASKET-3</b>	Factory installed for HCWB1-, HCWB1R- and HCWB1X-3DA	<b>122</b>
<b>BEZELGASKET-4</b>	Factory installed for HCWB1-, HCWB1R- and HCWB1X-4DA	<b>122</b>
<b>BEZELGASKET-5</b>	Factory installed for HCWB1-, HCWB1R- and HCWB1X-5DA	<b>131</b>
<b>BEZELGASKET-6</b>	Factory installed for HCWB1-, HCWB1R- and HCWB1X-6DA	<b>131</b>

### ACCESSORIES (available for purchase at any time)

<b>FR2-FLUSH</b>	Flush Hose, Cleaning Brush, Stopper and Adapter	<b>\$113</b>
<b>CWB12BAR</b>	12" Pan Support for Drop-In Refrigerated Wells	<b>24</b>
<b>CWB20BAR</b>	20" Pan Support for Drop-In Refrigerated Wells	<b>28</b>

### PANS AND TRIVET ACCESSORIES – PAGE 24

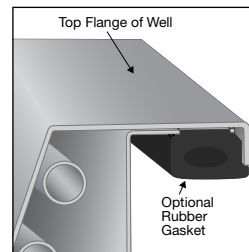

**BEZELGASKET-2, -3, -4, -5, -6**  
Factory installed option (eliminates the need for silicone or other sealants)



**FR2-FLUSH**

### DROP-IN HOT/COLD WELLS COUNTERTOP CUT-OUTS

Model	Minimum Width	Maximum Width	Minimum Depth	Maximum Depth
HCWB1-2DA	30 1/8"	31"	25 3/16"	26"
HCWB1-3DA	43 1/8"	44"	25 3/16"	26"
HCWB1-4DA	56 1/8"	57"	25 3/16"	26"
HCWB1-5DA	69 1/8"	70"	25 3/16"	26"
HCWB1-6DA	82 1/8"	83"	25 3/16"	26"

**Support Bars**  
Choose the appropriate kit for HCWB1 series

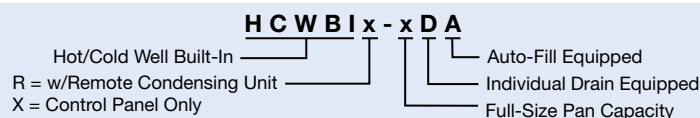



## Remote Drop-In Hot/Cold Wells

Whether it is breakfast in the morning or a salad bar at lunch, this well incorporates the legendary quality of both the hot and cold units into one, but in a remote configuration that offers unlimited flexibility for your own particular dining design needs.

**HCWBIR-2DA**  
with condensing unit (shipped loose) and control panel



Hot Mode: **HCWBIR-2DA** shown with accessory food pans and hot mode pan supports (included), which are designed specifically for easier and safer handling of foods.

**HCWBIX-2DA**  
with control panel



Cold Mode: **HCWBIX-2DA** shown with accessory food pans and cold pan support bars. Unique angled inside wall design provides easy access and clear views, while allowing cold air to effectively blanket your food product.

## Standard features

- Can house a variety of pans, full-size, half-size or third-size and are available in a two through six pan configuration
- Cold Mode: Similar to Hatco's CWB Cold Well, including auto-defrost, easy serviceability, optimal insulation and efficient condenser. Includes cold mode pan supports
- Hot Mode: Utilizes the same time-tested FR2 Hydro-Heater (Bain Marie) with "free flow" technology for an efficient and safe operation with a longer life, and includes drain, auto-fill and hot mode frame for pan support

### • HCWBIR-xx models only:

- Condenser utilizes R-513A refrigerant
- Includes a condensing unit (shipped loose – can be field mounted up to 50' of tubing from unit), an attached FR2 Hydro-Heater, control panel and TXV valve (TXV is shipped loose)

### • HCWBIX-xx models only:

- Includes control panel and FR2 Hydro-Heater but without a condensing unit for the increased flexibility of multiple hot/cold well configurations
- Solenoid valve attached to cold well with a TXV valve (TXV is shipped loose)

## DROP-IN HOT/COLD WELLS – WITH CONDENSING UNIT AND REMOTE CONTROL PANEL

Model	Dimensions W x D x H	HP	Watts Hot Mode	Approx. Ship Weight	120/208V		List Price		120/240V	
					Single Phase	Three Phase	Single Phase	Three Phase		
HCWBIR-2DA	32" x 27" x 26 5/8"	1/5	3000	214 lbs.	\$13750	\$14825	—	\$14825	—	—
HCWBIR-3DA	45" x 27" x 26 5/8"	1/5	3000	237 lbs.	14185	15260	—	15260	—	—
HCWBIR-4DA	58" x 27" x 26 5/8"	1/3	4000	285 lbs.	14783	15858	\$14783	15858	—	—
HCWBIR-5DA	71" x 27" x 26 5/8"	5/6	6000	343 lbs.	16681	17756	—	17756	—	—
HCWBIR-6DA	84" x 27" x 26 5/8"	5/6	6000	370 lbs.	18524	19599	—	19599	—	—

All models utilize R-513A Refrigerant.

### All Remote Drop-In Hot/Cold Well Models with a Condensing Unit and Remote Control Feature:

Models Shipped with: Remote-mounted control box, remote-mounted condensing unit and a TXV valve (shipped loose).

## DROP-IN HOT/COLD WELLS – WITH REMOTE CONTROL PANEL (without a condensing unit)

Model	Dimensions W x D x H	Load/BTU Hour	Hz	Approx. Ship Weight	120/208V		List Price		120/240V	
					Single Phase	Three Phase	Single Phase	Three Phase		
HCWBIX-2DA	32" x 27" x 26 5/8"	630	60	165 lbs.	\$12587	\$13662	—	\$13662	—	—
HCWBIX-3DA	45" x 27" x 26 5/8"	930	60	188 lbs.	13024	14099	—	14099	—	—
HCWBIX-4DA	58" x 27" x 26 5/8"	1230	60	235 lbs.	13616	14691	\$13616	14691	—	—
HCWBIX-5DA	71" x 27" x 26 5/8"	1530	60	268 lbs.	15188	16263	—	16263	—	—
HCWBIX-6DA	84" x 27" x 26 5/8"	1830	60	295 lbs.	17030	18105	—	18105	—	—

All models utilize R-513A Refrigerant.

### All Remote Drop-In Hot/Cold Well Models with a Remote Control (without a Condensing Unit) Feature:

Models Shipped with: Remote-mounted control box, a TXV valve (shipped loose) and a solenoid valve attached to well.

## OPTIONS, CUT-OUT DIMENSIONS AND ACCESSORIES – PAGE 20 PANS AND TRIVET ACCESSORIES – PAGE 24

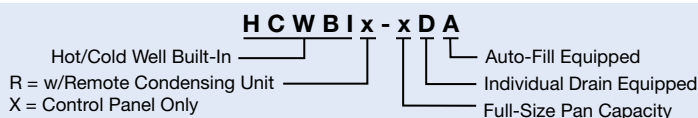

## Drop-In Ice Wells

Hatco Drop-In Ice Wells provide all the quality features of our Refrigerated Drop-Ins, but without any refrigeration or electrical components. These ice-cooled, insulated units can hold pre-chilled food products at preferred serving temperatures. Ideal for salad bars, cold buffets and chilled beverage bars. Pan dividers give you greater flexibility in your variety of featured food products.

- Full-size, insulated, top mount wells available to hold 1- to 6-pan configurations
- Optimal insulation on sides and bottom to ensure better cold retention and cost savings
- Bezel design allows clear viewing and easy food access
- Larger 1" NPT (National Pipe Thread) brass drain with flat screen simplifies cleaning
- False bottom accessory conveniently holds ice above drain for ease of draining
- Matches the Hatco line of Wells for a fully integrated look



**IWB-2 with slant option IWB-2SLANT**



**IWB-6** with an accessory food pan (bowls not available) and an optional gasket

### DROP-IN INSULATED ICE WELLS

Model	Dimensions W x D x H	Approx. Ship Weight	List Price
IWB-1	19" x 27" x 12"	62 lbs.	\$1961
IWB-2	32" x 27" x 12"	83 lbs.	2259
IWB-3	45" x 27" x 12"	102 lbs.	2617
IWB-4	58" x 27" x 12"	144 lbs.	3033
IWB-5	71" x 27" x 12"	110 lbs.	3511
IWB-6	84" x 27" x 12"	180 lbs.	4049

### OPTIONS (available at time of purchase only)

Slant Options –		
IWB-1SLANT	Slant Option for IWB-1	\$288
IWB-2SLANT	Slant Option for IWB-2	310
IWB-3SLANT	Slant Option for IWB-3	333
IWB-4SLANT	Slant Option for IWB-4	355
IWB-5SLANT	Slant Option for IWB-5	378
IWB-6SLANT	Slant Option for IWB-6	400

Gasket Options –		
BEZELGASKET-1	Factory installed for IWB-1	\$ 93
BEZELGASKET-2	Factory installed for IWB-2	93
BEZELGASKET-3	Factory installed for IWB-3	122
BEZELGASKET-4	Factory installed for IWB-4	122
BEZELGASKET-5	Factory installed for IWB-5	131
BEZELGASKET-6	Factory installed for IWB-6	131

### ACCESSORIES – PAGE 24

### DROP-IN ICE WELL COUNTERTOP CUT-OUTS

Model	Minimum Width	Maximum Width	Minimum Depth	Maximum Depth
IWB-1	17 <sup>1</sup> / <sub>8</sub> "	18"	25 <sup>3</sup> / <sub>16</sub> "	26"
IWB-2	30 <sup>7</sup> / <sub>8</sub> "	31"	25 <sup>3</sup> / <sub>16</sub> "	26"
IWB-3	43 <sup>1</sup> / <sub>8</sub> "	44"	25 <sup>3</sup> / <sub>16</sub> "	26"
IWB-4	56 <sup>1</sup> / <sub>8</sub> "	57"	25 <sup>3</sup> / <sub>16</sub> "	26"
IWB-5	69 <sup>1</sup> / <sub>8</sub> "	70"	25 <sup>3</sup> / <sub>16</sub> "	26"
IWB-6	82 <sup>1</sup> / <sub>8</sub> "	83"	25 <sup>3</sup> / <sub>16</sub> "	26"

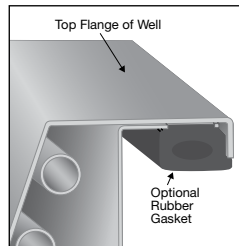
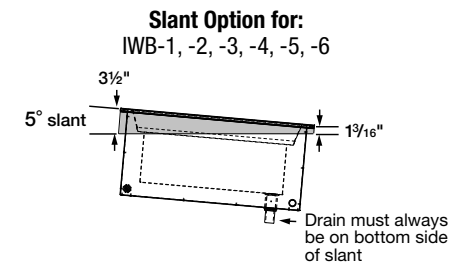

**BEZELGASKET-1**  
Factory installed option (eliminates the need for silicone or other sealants)

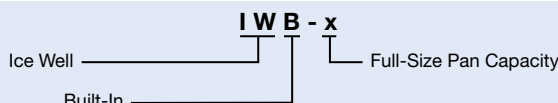
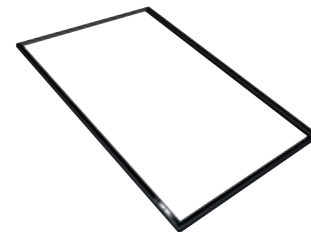

## Drop-In Slim Ice Wells

Hatco Drop-In Slim Ice Wells provide all the quality features of our Refrigerated Drop-Ins, but without any refrigeration or electrical components. Now available in a slim configuration providing customers with a complete well within easy reach.

Ideal for salad bars, cold buffets and chilled beverage bars. Pan dividers give you greater flexibility in your variety of featured food products.

- Holds 1- to 4-full-size pan configurations, but placed lengthwise
- Optimal insulation on sides and bottom to ensure better cold retention and cost savings
- Bezel design allows clear viewing and easy food access

- Larger 1" NPT (National Pipe Thread) brass drain with flat screen simplifies cleaning
- False bottom accessory conveniently holds ice above drain for ease of draining



**IWB-S4**  
with optional  
**IWB-S4SLANT**



**IWB-S2**

### DROP-IN INSULATED SLIM ICE WELLS

Model	Dimensions W x D x H	Approx. Ship Weight	List Price
<b>IWB-S1</b>	27 <sup>1</sup> / <sub>16</sub> " x 19" x 12"	58 lbs.	<b>\$2036</b>
<b>IWB-S2</b>	48 <sup>1</sup> / <sub>8</sub> " x 19" x 12"	105 lbs.	<b>2334</b>
<b>IWB-S3</b>	69 <sup>3</sup> / <sub>16</sub> " x 19" x 12"	145 lbs.	<b>2692</b>
<b>IWB-S4</b>	90 <sup>1</sup> / <sub>4</sub> " x 19" x 12"	202 lbs.	<b>3108</b>

### OPTIONS (available at time of purchase only)

#### Slant Options –

<b>IWB-S1SLANT</b>	Slant Option for IWB-S1	<b>\$288</b>
<b>IWB-S2SLANT</b>	Slant Option for IWB-S2	<b>310</b>
<b>IWB-S3SLANT</b>	Slant Option for IWB-S3	<b>333</b>
<b>IWB-S4SLANT</b>	Slant Option for IWB-S4	<b>355</b>

#### Gasket Options –

<b>BEZELGASKET-S1</b>	Factory installed for IWB-S1	<b>\$ 93</b>
<b>BEZELGASKET-S2</b>	Factory installed for IWB-S2	<b>93</b>
<b>BEZELGASKET-S3</b>	Factory installed for IWB-S3	<b>122</b>
<b>BEZELGASKET-S4</b>	Factory installed for IWB-S4	<b>122</b>

### ACCESSORIES – PAGE 24

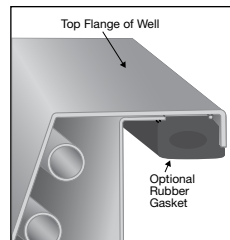
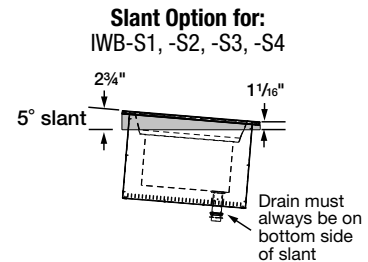

**BEZELGASKET-S1**  
Factory installed option  
(eliminates the need for  
silicone or other sealants)

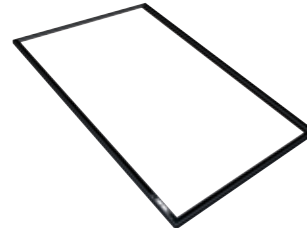

### DROP-IN SLIM ICE WELLS COUNTERTOP CUT-OUTS

Model	Minimum Width	Maximum Width	Minimum Depth	Maximum Depth
<b>IWB-S1</b>	25 <sup>1</sup> / <sub>4</sub> "	26 <sup>1</sup> / <sub>16</sub> "	17 <sup>1</sup> / <sub>16</sub> "	17 <sup>15</sup> / <sub>16</sub> "
<b>IWB-S2</b>	46 <sup>1</sup> / <sub>4</sub> "	47 <sup>1</sup> / <sub>8</sub> "	17 <sup>1</sup> / <sub>16</sub> "	17 <sup>15</sup> / <sub>16</sub> "
<b>IWB-S3</b>	67 <sup>7</sup> / <sub>16</sub> "	68 <sup>3</sup> / <sub>16</sub> "	17 <sup>1</sup> / <sub>16</sub> "	17 <sup>15</sup> / <sub>16</sub> "
<b>IWB-S4</b>	88 <sup>3</sup> / <sub>8</sub> "	89 <sup>1</sup> / <sub>4</sub> "	17 <sup>1</sup> / <sub>16</sub> "	17 <sup>15</sup> / <sub>16</sub> "

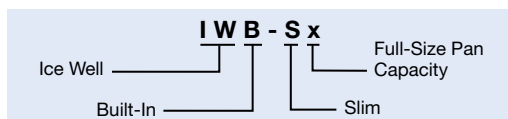

## Drop-In Ice Well Accessories *(available for purchase at any time)*



**IWB-6**  
with accessory food pan  
(bowls not available)

### PANS – TRIVETS *(available for purchase at any time)*

<b>ST PAN 1/3</b>	Third-Size Stainless Steel Pan – 12 $\frac{3}{4}$ "W x 6 $\frac{7}{8}$ "D x 2 $\frac{1}{2}$ "H	<b>\$ 68</b>
<b>ST PAN 1/2</b>	Half-Size Stainless Steel Pan – 12 $\frac{3}{4}$ "W x 10 $\frac{3}{4}$ "D x 2 $\frac{1}{2}$ "H	<b>78</b>
<b>ST PAN 2</b>	Full-Size Stainless Steel Pan – 12 $\frac{3}{4}$ "W x 20 $\frac{3}{4}$ "D x 2 $\frac{1}{2}$ "H	<b>93</b>
<b>ST PAN 4</b>	Full-Size Stainless Steel Pan – 12 $\frac{3}{4}$ "W x 20 $\frac{3}{4}$ "D x 4"H	<b>117</b>
<b>HDW 6" PAN</b>	Full-Size Stainless Steel Pan – 12 $\frac{3}{4}$ "W x 20 $\frac{3}{4}$ "D x 6"H	<b>127</b>
<b>Wire Trivets Stainless –</b>		
<b>TRIVET (1/2)SS</b>	Half-Size – 10 $\frac{1}{16}$ "W x 7 $\frac{7}{8}$ "D	<b>\$126</b>
<b>TRIVET SS</b>	Full-Size – 10 $\frac{1}{16}$ "W x 18"D	<b>175</b>

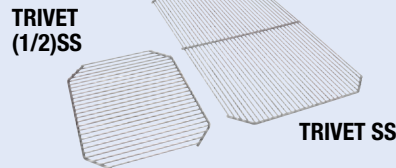

**Support Bars**  
Choose the appropriate  
kit for IWB or  
CWB series

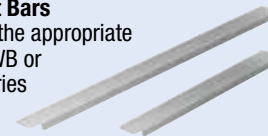

### SUPPORT BARS – FALSE BOTTOMS *(available for purchase at any time)*

<b>Bars –</b>		
<b>CWB12BAR</b>	12" Pan Support Bar for Drop-In Ice or Refrigerated Wells	<b>\$24</b>
<b>CWB20BAR</b>	20" Pan Support Bar for Drop-In Ice or Refrigerated Wells	<b>28</b>

<b>False Bottoms for Ice Wells (allows for 3<math>\frac{1}{2}</math>" of ice and sits on ledge of well) –</b>		
<b>1FB3.5</b>	For IWB-1 models (includes one 1-pan Insert)	<b>\$109</b>
<b>2FB3.5</b>	For IWB-2 models (includes one 2-pan Insert)	<b>199</b>
<b>3FB3.5</b>	For IWB-3 models (includes one 1-pan Insert and one 2-pan Insert)	<b>289</b>
<b>4FB3.5</b>	For IWB-4 models (includes two 2-pan Insert)	<b>379</b>
<b>5FB3.5</b>	For IWB-5 models (includes one 1-pan Insert and two 2-pan Inserts)	<b>469</b>
<b>6FB3.5</b>	For IWB-6 models (includes three 2-pan Inserts)	<b>559</b>

<b>False Bottoms for Slim Ice Wells (allows for 3<math>\frac{1}{2}</math>" of ice and sits on ledge of well) –</b>		
<b>1FB3.5</b>	For IWB-S1 models (includes one 1-pan Insert)	<b>\$109</b>
<b>2FB3.5</b>	For IWB-S2 models (includes one 2-pan Insert)	<b>199</b>
<b>3FB3.5</b>	For IWB-S3 models (includes one 1-pan Insert and one 2-pan Insert)	<b>289</b>
<b>4FB3.5</b>	For IWB-S4 models (includes two 2-pan Inserts)	<b>379</b>

<b>False Bottoms for Ice Wells (allows for 8" of ice and sits on bottom of well) –</b>		
<b>1FB8</b>	For IWB-1 models (includes one 1-pan Insert)	<b>\$109</b>
<b>2FB8</b>	For IWB-2 models (includes one 2-pan Insert)	<b>199</b>
<b>3FB8</b>	For IWB-3 models (includes one 1-pan Insert and one 2-pan Insert)	<b>289</b>
<b>4FB8</b>	For IWB-4 models (includes two 2-pan Insert)	<b>379</b>
<b>5FB8</b>	For IWB-5 models (includes one 1-pan Insert and two 2-pan Inserts)	<b>469</b>
<b>6FB8</b>	For IWB-6 models (includes three 2-pan Inserts)	<b>559</b>

<b>False Bottoms for Slim Ice Wells (allows for 8" of ice and sits on bottom of well) –</b>		
<b>1FBS8</b>	For IWB-S1 models (includes one 1-pan Insert)	<b>\$109</b>
<b>2FBS8</b>	For IWB-S2 models (includes one 2-pan Insert)	<b>199</b>
<b>3FBS8</b>	For IWB-S3 models (includes one 1-pan Insert and one 2-pan Insert)	<b>289</b>
<b>4FBS8</b>	For IWB-S4 models (includes two 2-pan Inserts)	<b>379</b>

2FB8 Accessory

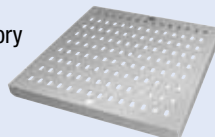

### False Bottom Accessories

1-part, 2-part or 3-part(s) depending on pan size

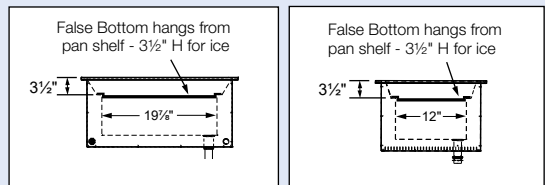

(1, 2, 3, 4, 5 or 6FB3.5)  
for the IWB Series

(1, 2, 3 or 4FBS3.5)  
for the IWB-S Series

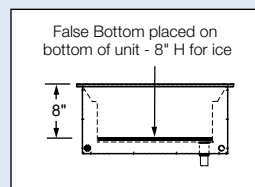
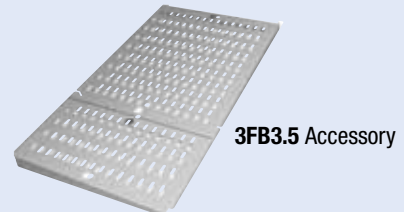

(1, 2, 3, 4, 5 or 6FB8)  
for the IWB Series

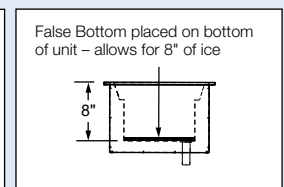

(1, 2, 3 or 4FBS8)  
for the IWB-S Series



# R-290 Refrigerated Drop-In Wells Ordering Instructions

Cutaway of CWBP-6 with accessory food pans

NSF 7 Component approved cold wall construction, keeping food product cold without drying it out

A Refrigerated Well when combined with accessory support bars can house a variety of pans – full-size, half-size or third-size – showcasing a variety of your food products

The greater surface area of the angled wall and the placement of the coils allow cold air to more effectively blanket your food product

The unique top bezel design also provides easy access and clear views

3"

The R-290 Refrigerated Well uses an environmentally friendly R-290 refrigerant

The well cavity ensures energy efficiency with environmentally-friendly insulation used throughout

**Please specify the following with each order:**

1. **Desired Voltage:**  
120V, single phase
2. **Number of Drop-In Wells Required:**
  - A. **Standard Configuration**  
1-, 2-, 3-, 4-, 5- or 6-pan as rectangular, full-size (12" x 20")
  - B. **Slim configuration**  
S1-, S2-, S3- or S4-pan as rectangular, full-size (12" x 20") but placed lengthwise
3. **Depth of Model:** Standard configuration (27"D) or Slim configuration (19"D)
4. **Agency – UL, C-UL, NSF 7 Component**
5. **Electronic Control Assembly** can be mounted on either side of the Condensing Unit or remotely mounted up to 4' from the unit (cannot be mounted over the Condensing Unit)

**Options**

1. Additional four year parts only warranty on the Compressor available at the time of unit purchase
2. **Slant Option** for CWBP-1, -2, -3, -4, -5, -6 or CWBP-S1, -S2, -S3, -S4
3. **Gasket Option** for CWBP-1, -2, -3, -4, -5, -6 or CWBP-S1, -S2, -S3, -S4

**Accessories**

1. **Pan Support Bars:** 12" or 20"
2. **Stainless Steel Pans:**
  - A. **Third-size**  
12¾"W x 6⅞"D x 2½"H
  - B. **Half-size**  
12¾"W x 10⅞"D x 2½"H
  - C. **Full-size at 2½" deep**  
12¾"W x 20¾"D x 2½"H
  - D. **Full-size at 4" deep**  
12¾"W x 20¾"D x 4"H
  - E. **Full-size at 6" deep**  
12¾"W x 20¾"D x 6"H

Electronic control assembly can be mounted on either side of the condensing unit or remotely mounted up to 4 feet away

**R-290 REFRIGERATED DROP-IN WELLS COUNTERTOP CUT-OUTS**

Model	Minimum Width	Maximum Width	Minimum Depth	Maximum Depth
<b>CWBP-1</b>	17⅞"	18"	25⅜"	26"
<b>CWBP-2</b>	30⅞"	31"	25⅜"	26"
<b>CWBP-3</b>	43⅞"	44"	25⅜"	26"
<b>CWBP-4</b>	56⅞"	57"	25⅜"	26"
<b>CWBP-5</b>	69⅞"	70"	25⅜"	26"
<b>CWBP-6</b>	82⅞"	83"	25⅜"	26"
<b>Slim Series</b>				
<b>CWBP-S1</b>	25¼"	26⅜"	17⅜"	17⅝"
<b>CWBP-S2</b>	46¼"	47⅞"	17⅜"	17⅝"
<b>CWBP-S3</b>	67⅝"	68⅜"	17⅜"	17⅝"
<b>CWBP-S4</b>	88⅜"	89¼"	17⅜"	17⅝"

The unique angled inside wall design provides easy access and clear views. The greater surface area of the angled wall and the placement of the coils allow cold air to more effectively blanket your food product.

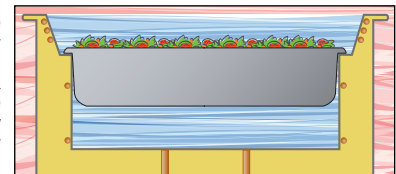

## R-290 Refrigerated Drop-In Wells

Hatco's R-290 Refrigerated Drop-In Well is a full-size unit that uses an environmentally friendly R-290 refrigerant to blanket your pre-chilled food product to retain optimum freshness and taste in one efficient and easy operation – a winner for your foodservice operation.

- Full-size, insulated wells available in 1- to 6-pan configurations
- NSF 7 Component approved cold wall construction keeps food cold without drying it out
- Electronic control assembly can be mounted on either side of the condensing unit or remotely mounted up to 4 feet
- Auto-defrost is activated through an advanced electronic controller programmed at the customer location

- Condenser utilizes an environmentally friendly R-290 refrigerant, which has a 90% higher heat absorption capacity than other refrigerants, resulting in quicker temperature recovery and lower energy consumption
- Optimal insulation on sides and bottom to ensure better cold retention. Environmentally friendly insulation used throughout
- 1" brass drain simplifies cleaning



CWBP-6 with accessory food pans and pan support bars

CWBP-2 with slant option CWBP-2SLANT



### R-290 REFRIGERATED DROP-IN WELLS

Model	Dimensions W x D x H	Voltage	HP and Watts @ 60 Hz			Approx. Ship Weight	List Price
			HP	Watts	Plug		
CWBP-1	19" x 27" x 32 <sup>1</sup> / <sub>10</sub> "	120	1/5	345	NEMA 5-15P	127 lbs.	\$ 7593
CWBP-2	32" x 27" x 32 <sup>1</sup> / <sub>10</sub> "	120	1/5	345	NEMA 5-15P	150 lbs.	8027
CWBP-3	45" x 27" x 25 <sup>1</sup> / <sub>2</sub> "	120	1/5	345	NEMA 5-15P	173 lbs.	8548
CWBP-4	58" x 27" x 25 <sup>1</sup> / <sub>2</sub> "	120	1/3	440	NEMA 5-15P	211 lbs.	9301
CWBP-5	71" x 27" x 25 <sup>1</sup> / <sub>2</sub> "	120	1/2	560	NEMA 5-15P	245 lbs.	9832
CWBP-6	84" x 27" x 25 <sup>1</sup> / <sub>2</sub> "	120	1/2	560	NEMA 5-15P	292 lbs.	10724

#### All Refrigerated Drop-In Well Models Feature:

Voltage: Single phase.

Models Shipped with: Electronic temperature control, pan support bars for full-size pans, condensing unit, auto-defrost and filter-drier. Consult factory for refrigerant specifications.

**NOTE:** The installation kit, including the intake bracket, duct clamp, flexible duct, and duct collar, will be shipped separately.

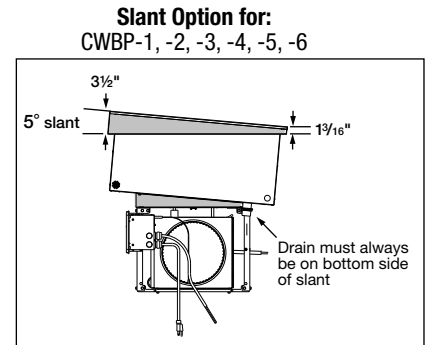

### OPTIONS (available at time of purchase only)

EWC	Additional Four Year Parts Only Warranty on the Compressor	\$200
<b>Slant Options –</b>		
CWBP-1SLANT	Slant Option for CWBP-1	\$382
CWBP-2SLANT	Slant Option for CWBP-2	404
CWBP-3SLANT	Slant Option for CWBP-3	427
CWBP-4SLANT	Slant Option for CWBP-4	449
CWBP-5SLANT	Slant Option for CWBP-5	472
CWBP-6SLANT	Slant Option for CWBP-6	494
<b>Gasket Options –</b>		
BEZELGASKET-1	Factory installed for CWBP-1	\$ 93
BEZELGASKET-2	Factory installed for CWBP-2	93
BEZELGASKET-3	Factory installed for CWBP-3	122
BEZELGASKET-4	Factory installed for CWBP-4	122
BEZELGASKET-5	Factory installed for CWBP-5	131
BEZELGASKET-6	Factory installed for CWBP-6	131

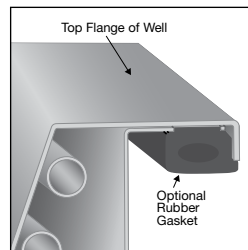

**BEZELGASKET-1**  
Factory installed option (eliminates the need for silicone or other sealants)

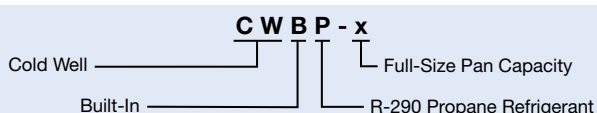
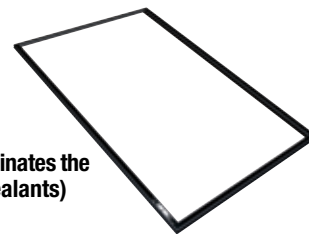

## R-290 Refrigerated Slim Drop-In Wells

Hatco's R-290 Refrigerated Slim Drop-In Well is a full-size unit that uses an environmentally friendly R-290 refrigerant to blanket your pre-chilled food product to retain optimum freshness and taste in one efficient and easy operation – but placed lengthwise. This provides customers with a complete cold well within easy reach.

- Insulated wells available in 1 to 4 full-size pan configurations
- NSF 7 Component approved cold wall construction keeps food product cold without drying it out
- Condenser utilizes an environmentally friendly R-290 refrigerant, which has a 90% higher heat absorption capacity than other refrigerants, resulting in quicker temperature recovery and lower energy consumption
- Auto-defrost is activated through an advanced electronic controller programmed at customer location
- Optimal insulation on sides and bottom ensure better cold retention
- 1" brass drain simplifies cleaning



**CWBP-S4**  
with accessory (hotel) food pans and additional pan support bars



### R-290 REFRIGERATED SLIM DROP-IN WELLS

Model	Dimensions W x D x H	HP and Watts @ 60 Hz			Approx. Ship Weight	List Price
		HP	Watts	Plug		
<b>CWBP-S1</b>	27 <sup>1</sup> / <sub>16</sub> " x 19" x 26 <sup>1</sup> / <sub>16</sub> "	1/5	345	NEMA 5-15P	133 lbs.	<b>\$ 7443</b>
<b>CWBP-S2</b>	48 <sup>1</sup> / <sub>8</sub> " x 19" x 26 <sup>1</sup> / <sub>16</sub> "	1/5	345	NEMA 5-15P	170 lbs.	<b>8350</b>
<b>CWBP-S3</b>	69 <sup>3</sup> / <sub>16</sub> " x 19" x 26 <sup>1</sup> / <sub>16</sub> "	1/3	440	NEMA 5-15P	221 lbs.	<b>9517</b>
<b>CWBP-S4</b>	90 <sup>1</sup> / <sub>4</sub> " x 19" x 26 <sup>1</sup> / <sub>16</sub> "	1/2	560	NEMA 5-15P	283 lbs.	<b>10266</b>

**All Refrigerated Slim Drop-In Well Models Feature:**

**Voltage:** 120V, single phase.

**Models Shipped with:** Electronic temperature control, pan support bars for full-size pans, condensing unit, auto-defrost, sight glass, and filter-drier. Consult factory for refrigerant specifications.

**NOTE:** The installation kit, including the intake bracket, duct clamp, flexible duct, and duct collar, will be shipped separately.

**Slant Option for:**  
CWBP-S1, -S2, -S3, -S4

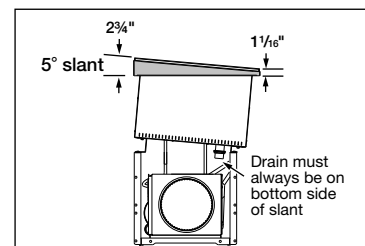

**OPTIONS** (available at time of purchase only)

<b>EWC</b>	Additional Four Year Parts Only Warranty on the Compressor	<b>\$200</b>
<b>Slant Options –</b>		
<b>CWBP-S1SLANT</b>	Slant Option for CWBP-S1	<b>\$318</b>
<b>CWBP-S2SLANT</b>	Slant Option for CWBP-S2	<b>340</b>
<b>CWBP-S3SLANT</b>	Slant Option for CWBP-S3	<b>363</b>
<b>CWBP-S4SLANT</b>	Slant Option for CWBP-S4	<b>385</b>
<b>Gasket Options –</b>		
<b>BEZELGASKET-S1</b>	Factory installed for CWBP-S1	<b>\$ 93</b>
<b>BEZELGASKET-S2</b>	Factory installed for CWBP-S2	<b>93</b>
<b>BEZELGASKET-S3</b>	Factory installed for CWBP-S3	<b>122</b>
<b>BEZELGASKET-S4</b>	Factory installed for CWBP-S4	<b>122</b>

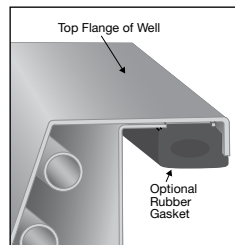

**BEZELGASKET-S2**  
Factory installed option  
(eliminates the need for  
silicone or other sealants)

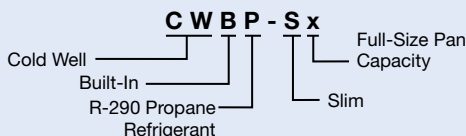

## Refrigerated Drop-In Wells Ordering Instructions

Wells

Cutaway of CWB-6 with accessory food pans

NSF 7 Component approved cold wall construction, keeping food product cold without drying it out

A Refrigerated Well when combined with accessory support bars can house a variety of pans – full-size, half-size or third-size – showcasing a variety of your food products

The greater surface area of the angled wall and the placement of the coils allow cold air to more effectively blanket your food product

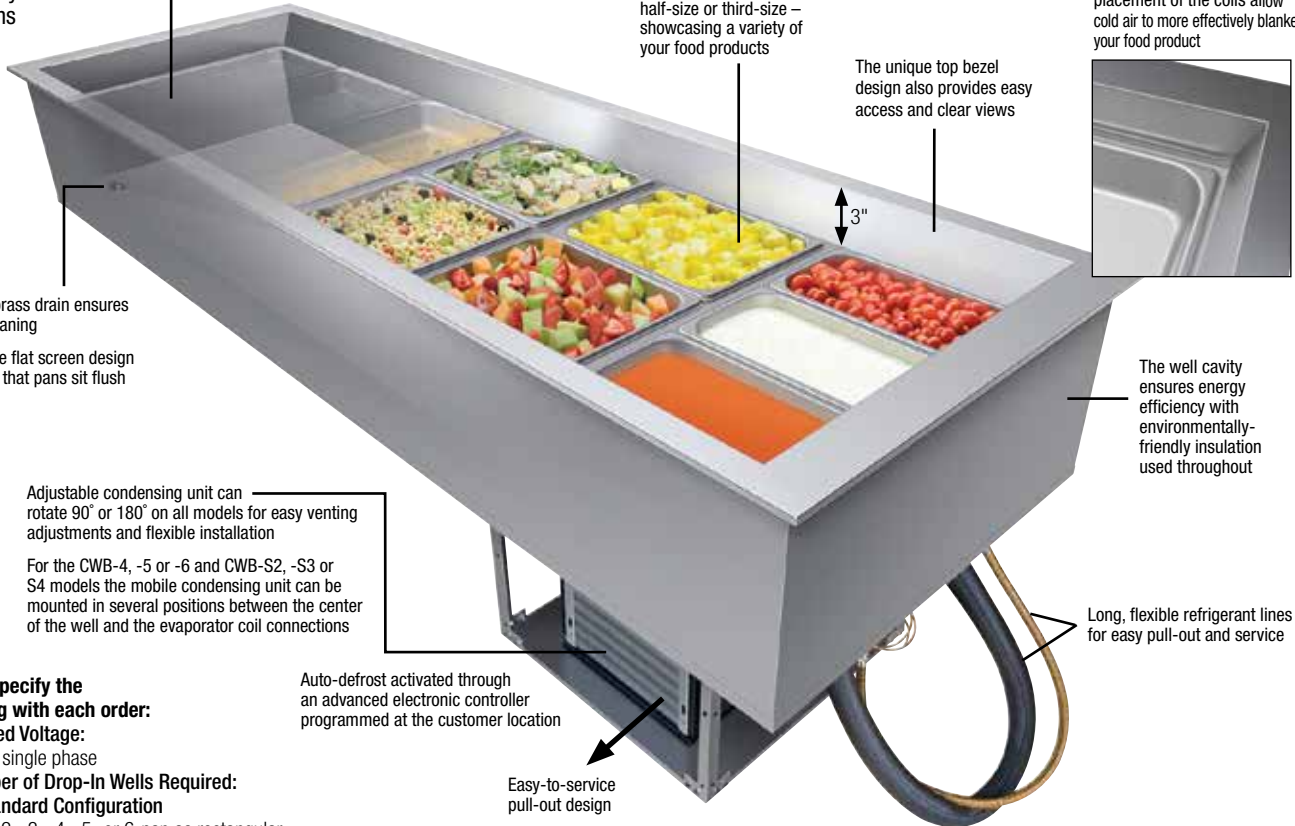

Larger brass drain ensures easy cleaning  
Exclusive flat screen design ensures that pans sit flush

Adjustable condensing unit can rotate 90° or 180° on all models for easy venting adjustments and flexible installation

For the CWB-4, -5 or -6 and CWB-S2, -S3 or S4 models the mobile condensing unit can be mounted in several positions between the center of the well and the evaporator coil connections

**Please specify the following with each order:**

- Desired Voltage:**  
120V, single phase
- Number of Drop-In Wells Required:**
  - Standard Configuration**  
1-, 2-, 3-, 4-, 5- or 6-pan as rectangular, full-size (12" x 20")
  - Slim configuration**  
S1-, S2-, S3- or S4-pan as rectangular, full-size (12" x 20") but placed lengthwise
- Depth of Model:** Standard configuration (27"D) or Slim configuration (19"D)
- Agency** – UL, C-UL, NSF 7 Component
- Electronic Control Assembly** can be mounted on either side of the Condensing Unit or remotely mounted up to 4' from the unit (cannot be mounted over the Condensing Unit)

**Options**

- Additional four year parts only warranty on the Compressor available at the time of unit purchase
- Slant Option** for CWB-1, -2, -3, -4, -5, -6 or CWB-S1, -S2, -S3, -S4
- Gasket Option** for CWB-1, -2, -3, -4, -5, -6 or CWB-S1, -S2, -S3, -S4

**Accessories**

- Pan Support Bars:** 12" or 20"
- Stainless Steel Pans:**
  - Third-size  
12<sup>3</sup>/<sub>4</sub>"W x 6<sup>7</sup>/<sub>8</sub>"D x 2<sup>1</sup>/<sub>2</sub>"H
  - Half-size  
12<sup>3</sup>/<sub>4</sub>"W x 10<sup>9</sup>/<sub>16</sub>"D x 2<sup>1</sup>/<sub>2</sub>"H
  - Full-size at 2<sup>1</sup>/<sub>2</sub>" deep  
12<sup>3</sup>/<sub>4</sub>"W x 20<sup>3</sup>/<sub>4</sub>"D x 2<sup>1</sup>/<sub>2</sub>"H
  - Full-size at 4" deep  
12<sup>3</sup>/<sub>4</sub>"W x 20<sup>3</sup>/<sub>4</sub>"D x 4"H
  - Full-size at 6" deep  
12<sup>3</sup>/<sub>4</sub>"W x 20<sup>3</sup>/<sub>4</sub>"D x 6"H
- Perforated False Bottom**

**ACCESSORIES – PAGE 34**

From below, you can see the condenser unit after being pulled out by the technician, allowing easy access and visibility to all service components



The sight glass gives an inside look into a usually closed system to determine if the refrigerant is low or if there is water in the system

**REFRIGERATED DROP-IN WELLS COUNTERTOP CUT-OUTS**

Model	Minimum Width	Maximum Width	Minimum Depth	Maximum Depth
<b>CWB-1</b>	17 <sup>1</sup> / <sub>8</sub> "	18"	25 <sup>3</sup> / <sub>16</sub> "	26"
<b>CWB-2</b>	30 <sup>7</sup> / <sub>8</sub> "	31"	25 <sup>3</sup> / <sub>16</sub> "	26"
<b>CWB-3</b>	43 <sup>3</sup> / <sub>8</sub> "	44"	25 <sup>3</sup> / <sub>16</sub> "	26"
<b>CWB-4</b>	56 <sup>7</sup> / <sub>8</sub> "	57"	25 <sup>3</sup> / <sub>16</sub> "	26"
<b>CWB-5</b>	69 <sup>7</sup> / <sub>8</sub> "	70"	25 <sup>3</sup> / <sub>16</sub> "	26"
<b>CWB-6</b>	82 <sup>1</sup> / <sub>8</sub> "	83"	25 <sup>3</sup> / <sub>16</sub> "	26"
<b>Slim Series</b>				
<b>CWB-S1</b>	25 <sup>1</sup> / <sub>4</sub> "	26 <sup>1</sup> / <sub>16</sub> "	17 <sup>1</sup> / <sub>16</sub> "	17 <sup>15</sup> / <sub>16</sub> "
<b>CWB-S2</b>	46 <sup>1</sup> / <sub>4</sub> "	47 <sup>7</sup> / <sub>8</sub> "	17 <sup>1</sup> / <sub>16</sub> "	17 <sup>15</sup> / <sub>16</sub> "
<b>CWB-S3</b>	67 <sup>5</sup> / <sub>16</sub> "	68 <sup>3</sup> / <sub>16</sub> "	17 <sup>1</sup> / <sub>16</sub> "	17 <sup>15</sup> / <sub>16</sub> "
<b>CWB-S4</b>	88 <sup>3</sup> / <sub>8</sub> "	89 <sup>1</sup> / <sub>4</sub> "	17 <sup>1</sup> / <sub>16</sub> "	17 <sup>15</sup> / <sub>16</sub> "

The unique angled inside wall design provides easy access and clear views. The greater surface area of the angled wall and the placement of the coils allow cold air to more effectively blanket your food product.

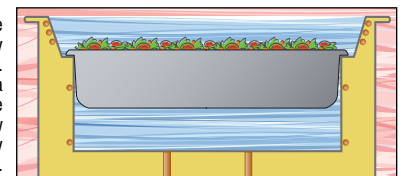



## Refrigerated Drop-In Wells

Hatco's Refrigerated Drop-In Well is a full-size unit that blankets your pre-chilled food product to retain optimum freshness and taste in one efficient and easy operation – a winner for your foodservice operation.



**CWB-6** with accessory food pans and pan support bars

- Full-size, insulated wells available in 1- to 6-pan configurations
- NSF 7 Component approved cold wall construction keeps food cold without drying it out
- Electronic control assembly can be mounted on either side of the condensing unit or remotely mounted up to 4 feet
- Adjustable condensing unit can be rotated 90° or 180° on all models for easy venting and flexibility at installation
- For the CWB-4, -5 or -6 models the mobile condensing unit can be mounted in several positions between the center of the well and the evaporator coil connections at installation
- Auto-defrost is activated through an advanced electronic controller programmed at the customer location
- Optimal insulation on sides and bottom to ensure better cold retention. Environmentally-friendly insulation used throughout
- Easy serviceability with a sight glass, service valves, dryer and a receiver. Long, flexible refrigerant line (ability to pull out condensing unit) for service
- 1" NPT (National Pipe Thread) brass drain simplifies cleaning

**CWB-2** with slant option  
**CWB-2SLANT**



### DROP-IN FULL-SIZE INSULATED RECTANGULAR WELLS

Model	Dimensions W x D x H	Voltage	HP and Watts @ 60 Hz			Approx. Ship Weight	List Price
			HP	Watts	Plug		
<b>CWB-1</b>	19" x 27" x 25½"	120	1/5	300	NEMA 5-15P	133 lbs.	<b>\$ 7621</b>
<b>CWB-2</b>	32" x 27" x 25½"	120	1/5	300	NEMA 5-15P	155 lbs.	<b>8114</b>
<b>CWB-3</b>	45" x 27" x 25½"	120	1/5	300	NEMA 5-15P	173 lbs.	<b>8702</b>
<b>CWB-4</b>	58" x 27" x 25½"	120	1/3	450	NEMA 5-15P	211 lbs.	<b>9327</b>
<b>CWB-5</b>	71" x 27" x 25½"	120	5/8	800	NEMA 5-15P	248 lbs.	<b>10108</b>
<b>CWB-6</b>	84" x 27" x 25½"	120	5/8	800	NEMA 5-15P	292 lbs.	<b>10724</b>

**All Refrigerated Drop-In Well Models Feature:**

**Voltage:** Single phase.

**Models Shipped with:** Electronic temperature control, pan support bars for full-size pans, condensing unit (can be rotated), auto-defrost, sight glass, service valves and dryer. Consult factory for refrigerant specifications.

**Slant Option for:**  
CWB-1, -2, -3, -4, -5, -6

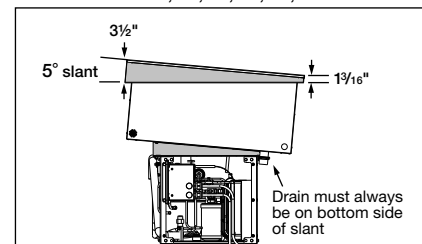

**OPTIONS** (available at time of purchase only)

<b>EWC</b>	Additional Four Year Parts Only Warranty on the Compressor	<b>\$200</b>
<b>Slant Options –</b>		
<b>CWB-1SLANT</b>	Slant Option for CWB-1	<b>\$382</b>
<b>CWB-2SLANT</b>	Slant Option for CWB-2	<b>404</b>
<b>CWB-3SLANT</b>	Slant Option for CWB-3	<b>427</b>
<b>CWB-4SLANT</b>	Slant Option for CWB-4	<b>449</b>
<b>CWB-5SLANT</b>	Slant Option for CWB-5	<b>472</b>
<b>CWB-6SLANT</b>	Slant Option for CWB-6	<b>494</b>
<b>Gasket Options –</b>		
<b>BEZELGASKET-1</b>	Factory installed for CWB-1	<b>\$ 93</b>
<b>BEZELGASKET-2</b>	Factory installed for CWB-2	<b>93</b>
<b>BEZELGASKET-3</b>	Factory installed for CWB-3	<b>122</b>
<b>BEZELGASKET-4</b>	Factory installed for CWB-4	<b>122</b>
<b>BEZELGASKET-5</b>	Factory installed for CWB-5	<b>131</b>
<b>BEZELGASKET-6</b>	Factory installed for CWB-6	<b>131</b>

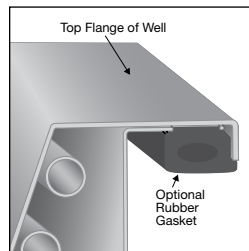

**BEZELGASKET-1**  
Factory installed option (eliminates the need for silicone or other sealants)

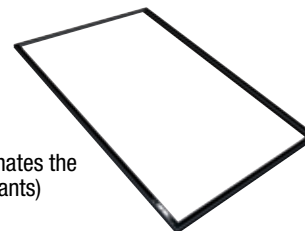

**COUNTERTOP CUT-OUT DIMENSIONS – PAGE 28**  
**ACCESSORIES – PAGE 34**

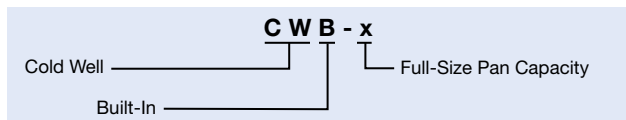

## Refrigerated Slim Drop-In Wells

Hatco's Refrigerated Slim Drop-In Well is a full-size unit that blankets your pre-chilled food product to retain optimum freshness and taste in one efficient and easy operation – but placed lengthwise. This provides customers with a complete cold well within easy reach.

- Insulated wells available in 1 to 4 full-size pan configurations
- NSF 7 Component approved cold wall construction keeps food product cold without drying it out
- Adjustable condensing unit can rotate 180° on all models for easy venting adjustments and flexibility at installation
- Mobile condensing unit can be moved in 4<sup>15</sup>/<sub>16</sub>" increments from left end to center on the 2-, 3- and 4-pan units at installation (CWB-S1 is rotatable only)
- Easy serviceability with a sight glass, service valves, dryer/filter and a receiver. Long, flexible refrigerant line (ability to pull out condensing unit) for service
- Auto-defrost is activated through an advanced electronic controller programmed at customer location
- Optimal insulation on sides and bottom ensure better cold retention
- 1" NPT (National Pipe Thread) brass drain simplifies cleaning

**CWB-S2**  
with accessory (hotel) food pans and additional pan support bars



**CWB-S4**  
with optional slant kit, accessory (hotel) food pans and additional pan support bars

### REFRIGERATED SLIM DROP-IN WELLS

Model	Dimensions W x D x H	HP and Watts @ 60 Hz			Approx. Ship Weight	List Price
		HP	Watts	Plug		
<b>CWB-S1</b>	27 <sup>1</sup> / <sub>16</sub> " x 19" x 33 <sup>1</sup> / <sub>2</sub> "	1/5	300	NEMA 5-15P	146 lbs.	<b>\$ 7621</b>
<b>CWB-S2</b>	48 <sup>1</sup> / <sub>8</sub> " x 19" x 26 <sup>1</sup> / <sub>16</sub> "	1/5	300	NEMA 5-15P	190 lbs.	<b>8350</b>
<b>CWB-S3</b>	69 <sup>3</sup> / <sub>16</sub> " x 19" x 26 <sup>1</sup> / <sub>16</sub> "	1/3	450	NEMA 5-15P	221 lbs.	<b>9629</b>
<b>CWB-S4</b>	90 <sup>1</sup> / <sub>4</sub> " x 19" x 26 <sup>1</sup> / <sub>16</sub> "	5/8	800	NEMA 5-15P	283 lbs.	<b>11583</b>

**All Refrigerated Slim Drop-In Well Models Feature:**

Voltage: 120V, single phase.

Models Shipped with: Electronic temperature control, pan support bars for full-size pans, condensing unit (can be rotated 180°), auto-defrost, sight glass, service valves and dryer. Consult factory for refrigerant specifications.

#### OPTIONS (available at time of purchase only)

<b>EWC</b>	Additional Four Year Parts Only Warranty on the Compressor	<b>\$200</b>
<b>Slant Options –</b>		
<b>CWB-S1SLANT</b>	Slant Option for CWB-S1	<b>\$318</b>
<b>CWB-S2SLANT</b>	Slant Option for CWB-S2	<b>340</b>
<b>CWB-S3SLANT</b>	Slant Option for CWB-S3	<b>363</b>
<b>CWB-S4SLANT</b>	Slant Option for CWB-S4	<b>385</b>
<b>Gasket Options –</b>		
<b>BEZELGASKET-S1</b>	Factory installed for CWB-S1	<b>\$ 93</b>
<b>BEZELGASKET-S2</b>	Factory installed for CWB-S2	<b>93</b>
<b>BEZELGASKET-S3</b>	Factory installed for CWB-S3	<b>122</b>
<b>BEZELGASKET-S4</b>	Factory installed for CWB-S4	<b>122</b>

**COUNTERTOP CUT-OUT DIMENSIONS – PAGE 28**  
**ACCESSORIES – PAGE 34**

**Slant Option for:**  
CWB-S1, -S2, -S3, -S4

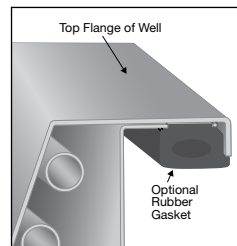
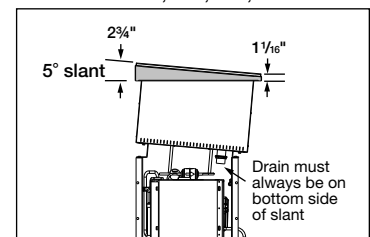

**BEZELGASKET-S1**  
Factory installed option (eliminates the need for silicone or other sealants)

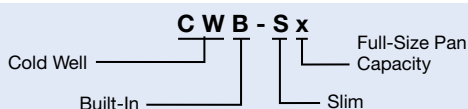

# Remote Refrigerated Drop-In Wells Ordering Instructions

Cutaway of **CWBR-6** with accessory food pans

Cold Well with: Temperature Probe

NSF 7 Component approved cold wall construction, keeping food product cold without drying it out

A Refrigerated Well can house a variety of pans – full-size, half-size or third-size – showcasing a variety of your food products

The unique top bezel design also provides easy access and clear views

The greater surface area of the angled wall and the placement of the coils allow cold air to more effectively blanket your food product

Larger brass drain ensures easy cleaning  
Exclusive flat screen design ensures that pans sit flush

Auto-defrost activated through an advanced electronic controller programmed at the customer location



**CWBR:** with a Condensing Unit  
**CWBX:** without a Condensing Unit

The well cavity ensures energy efficiency with environmentally-friendly insulation used throughout

**Please specify the following with each order:**

**1. Number of Drop-In Wells Required:**

- A. Standard Configuration**  
1-, 2-, 3-, 4-, 5- or 6-pan as rectangular, full-size (12" x 20")
- B. Slim configuration**  
S1-, S2-, S3- or S4-pan as rectangular, full-size (12" x 20") but placed lengthwise

**2. Depth of Model:** Standard configuration (27"D) or Slim configuration (19"D)

**3. Remote Refrigeration**

**NOTE:** Shipped loose: Cold Well with Temperature Probe, Control Panel (Probe Wires are 9') and a TXV Valve

**A. CWBR** with a Condensing Unit – may be field mounted up to 50' of tubing from the unit (shipped loose)

**B. CWBX** without a Condensing Unit (Solenoid Valve attached to Cold Well)

**4. Agency –** UL, C-UL, NSF 7 Component (CWBR units UL, C-UL only)

**Options**

1. Additional four year parts only warranty on the Compressor available at the time of unit purchase (CWBR only)
2. **Slant Option** for CWBR- and CWBX-1, -2, -3, -4, -5, and -6 or -S1, -S2, -S3, -S4
3. **Gasket Option** for CWBR- and CWBX-1, -2, -3, -4, -5, -6 or CWBR or CWBX-S1, -S2, -S3, -S4

**Accessories**

1. **Pan Support Bars:** 12" or 20"

**2. Stainless Steel Pans:**

- A. Third-size at 2½" deep  
12¾"W x 6½"D x 2½"H
- B. Half-size at 2½" deep  
12¾"W x 10¾"D x 2½"H
- C. Full-size at 2½" deep  
12¾"W x 20¾"D x 2½"H
- D. Full-size at 4" deep  
12¾"W x 20¾"D x 4"H
- E. Full-size at 6" deep  
12¾"W x 20¾"D x 6"H

**3. Perforated False Bottom**

**4. Trivets:**

- A. Half-size  
10⅞"W x 7⅞"D
- B. Full-size  
10⅞"W x 18"D

**REMOTE REFRIGERATED DROP-IN WELLS COUNTERTOP CUT-OUTS**

Model	Minimum Width	Maximum Width	Minimum Depth	Maximum Depth
<b>CWBR-1, CWBX-1</b>	17⅞"	18"	25⅜"	26"
<b>CWBR-2, CWBX-2</b>	30⅞"	31"	25⅜"	26"
<b>CWBR-3, CWBX-3</b>	43⅞"	44"	25⅜"	26"
<b>CWBR-4, CWBX-4</b>	56⅞"	57"	25⅜"	26"
<b>CWBR-5, CWBX-5</b>	69⅞"	70"	25⅜"	26"
<b>CWBR-6, CWBX-6</b>	82⅞"	83"	25⅜"	26"
<b>Slim Series</b>				
<b>CWBR-S1, CWBX-S1</b>	25¼"	26⅞"	17⅞"	18"
<b>CWBR-S2, CWBX-S2</b>	46¼"	47⅞"	17⅞"	18"
<b>CWBR-S3, CWBX-S3</b>	67⅞"	68⅞"	17⅞"	18"
<b>CWBR-S4, CWBX-S4</b>	88⅞"	89¼"	17⅞"	18"

**ACCESSORIES – PAGE 34**



## Remote Refrigerated Drop-In Wells

Hatco's Remote Refrigerated Drop-In Wells keep pre-chilled food products at safe-serving temperatures but in a remote configuration that offers unlimited flexibility for your own particular dining design needs.

- Full-size, insulated wells available in 1- to 6-pan configurations
- NSF 7 Component approved cold wall construction keeps food cold without drying it out
- Optimal insulation on sides and bottom to ensure better cold retention. Environmentally-friendly insulation used throughout
- CWBR models include a condensing unit (shipped loose, can be field mounted up to 50 feet of tubing from unit) and control panel (shipped loose - probe wires are 9 feet) for installing in more convenient or desirable locations

- CWBX model include a control panel (shipped loose - probe wires are 9 feet) but without a condensing unit for the increased flexibility of multiple cold well configurations
- Easy serviceability with a sight glass, service valves, dryer and a receiver (CWBR models only)
- Auto-defrost is activated through an advanced electronic controller programmed at the customer location
- 1" NPT (National Pipe Thread) brass drain simplifies cleaning



Control panel and a condensing unit (shipped loose)



CWBR-6 with accessory food pans and pan support bars



CWBX-6 with accessory food pans and pan support bars

Control panel (shipped loose)



### REMOTE REFRIGERATED DROP-IN FULL-SIZE WELLS – WITH CONDENSING UNIT AND REMOTE CONTROL PANEL

Model	Dimensions W x D x H	HP	Hz	Approx. Ship Weight	List Price
CWBR-1	19" x 27" x 12"	1/5	60	131 lbs.	\$6822
CWBR-2	32" x 27" x 12"	1/5	60	160 lbs.	7315
CWBR-3	45" x 27" x 12"	1/5	60	213 lbs.	7903
CWBR-4	58" x 27" x 12"	1/5	60	200 lbs.	8528
CWBR-5	71" x 27" x 12"	5/8	60	271 lbs.	9309
CWBR-6	84" x 27" x 12"	5/8	60	313 lbs.	9925

All Remote Refrigerated Drop-In Well Models with Condensing Unit and Remote Control Panel Feature:

Voltage: CWBR-1, -2, -3: 120V, 300 watts, single phase.

CWBR-4: 120V, 450 watts, single phase.

CWBR-5, -6: 120V, 800 watts, single phase.

Models Shipped with: Electronic temperature control, condensing unit and TXV valve (all shipped loose). Consult factory for refrigerant specifications.

### REMOTE REFRIGERATED DROP-IN FULL-SIZE WELLS – WITH REMOTE CONTROL PANEL

Model	Dimensions W x D x H	BTU/ Hour	Hz	Approx. Ship Weight	List Price
CWBX-1	19" x 27" x 17 1/16"	330	60	94 lbs.	\$5529
CWBX-2	32" x 27" x 17 1/16"	630	60	123 lbs.	6022
CWBX-3	45" x 27" x 17 1/16"	930	60	150 lbs.	6610
CWBX-4	58" x 27" x 17 1/16"	1230	60	176 lbs.	7235
CWBX-5	71" x 27" x 17 1/16"	1530	60	211 lbs.	8016
CWBX-6	84" x 27" x 17 1/16"	1830	60	250 lbs.	8632

All Remote Refrigerated Drop-In Well Models with Remote Control Panel Feature: Voltage: 120V, single phase.

Models Shipped with: Electronic temperature control, TXV valve (shipped loose) and a solenoid valve attached to well.

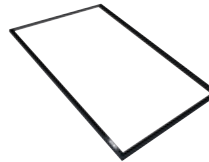

#### BEZELGASKET-1

Factory installed option (eliminates the need for silicone or other sealants)

### OPTIONS (available at time of purchase only)

EWC	Additional Four Year Parts Only Warranty on the Compressor (CWBR only)	\$200
<b>Slant Options –</b>		
CWBR-1SLANT	Slant Option for CWBR-1, CWBX-1	\$288
CWBR-2SLANT	Slant Option for CWBR-2, CWBX-2	310
CWBR-3SLANT	Slant Option for CWBR-3, CWBX-3	333
CWBR-4SLANT	Slant Option for CWBR-4, CWBX-4	355
CWBR-5SLANT	Slant Option for CWBR-5, CWBX-5	378
CWBR-6SLANT	Slant Option for CWBR-6, CWBX-6	400

#### Gasket Options –

BEZELGASKET-1	Factory installed for CWBR-1, CWBX-1	\$ 93
BEZELGASKET-2	Factory installed for CWBR-2, CWBX-2	93
BEZELGASKET-3	Factory installed for CWBR-3, CWBX-3	122
BEZELGASKET-4	Factory installed for CWBR-4, CWBX-4	122
BEZELGASKET-5	Factory installed for CWBR-5, CWBX-5	131
BEZELGASKET-6	Factory installed for CWBR-6, CWBX-6	131

### COUNTERTOP CUT-OUT DIMENSIONS – PAGE 31 ACCESSORIES – PAGE 34

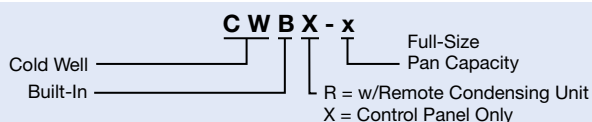



## Remote Refrigerated Slim Drop-In Wells

Hatco's Remote Refrigerated Slim Drop-In Well is a full-size unit that blankets your pre-chilled food product to retain optimum freshness and taste in one efficient and easy operation – but placed lengthwise and in two remote configurations. This provides customers with a complete cold well within easy reach, and unlimited flexibility for your design needs.

- Full-size, Insulated wells available in 1 to 4 full-size pan configurations
- NSF 7 Component approved cold wall construction keeps food product cold without drying it out
- Optimal insulation on sides and bottom to ensure better cold retention. Environmentally-friendly insulation used throughout
- CWBR-S models include a condensing unit (shipped loose, can be field mounted up to 50 feet of tubing from unit) and control panel (shipped loose - probe wires are 9 feet) for installing in more convenient or desirable locations
- CWBX-S model include a control panel (shipped loose - probe wires are 9 feet) but without a condensing unit for the increased flexibility of multiple cold well configurations
- Easy serviceability with a sight glass, service valves, dryer and a receiver (CWBR-S models only)
- Auto-defrost is activated through an advanced electronic controller programmed at customer location
- Optimal insulation on sides and bottom ensure better cold retention
- 1" NPT (National Pipe Thread) brass drain simplifies cleaning

Model **CWBR-S2** with accessory (hotel) food pans and additional support bars



Condensing unit (shipped loose)



Model **CWBX-S4** with accessory (hotel) food pans and additional support bars



Control panel (Shipped loose)

### REMOTE REFRIGERATED SLIM DROP-IN FULL-SIZE WELLS – WITH CONDENSING UNIT AND REMOTE CONTROL PANEL

Model	Dimensions W x D x H	HP	Watts	Approx. Ship Weight	List Price
<b>CWBR-S1</b>	27 <sup>1</sup> / <sub>16</sub> " x 19" x 12"	1/5	300	131 lbs.	<b>\$ 6822</b>
<b>CWBR-S2</b>	48 <sup>1</sup> / <sub>8</sub> " x 19" x 12"	1/5	300	162 lbs.	<b>7551</b>
<b>CWBR-S3</b>	69 <sup>9</sup> / <sub>16</sub> " x 19" x 12"	1/3	450	213 lbs.	<b>8830</b>
<b>CWBR-S4</b>	90 <sup>1</sup> / <sub>4</sub> " x 19" x 12"	5/8	800	235 lbs.	<b>10784</b>

### All Remote Refrigerated Slim Drop-In Well Models with Condensing Unit and Remote Control Panel Feature:

Voltage: 120V, single phase.

Models Shipped with: Electronic temperature control, condensing unit and TXV valve (all shipped loose). Consult factory for refrigerant specifications.

### REMOTE REFRIGERATED SLIM DROP-IN FULL-SIZE WELLS – WITH REMOTE CONTROL PANEL

Model	Dimensions W x D x H	Load/ BTU/H	Hz	Approx. Ship Weight	List Price
<b>CWBX-S1</b>	27 <sup>1</sup> / <sub>16</sub> " x 19" x 17 <sup>1</sup> / <sub>8</sub> "	330	60	94 lbs.	<b>\$5529</b>
<b>CWBX-S2</b>	48 <sup>1</sup> / <sub>8</sub> " x 19" x 17 <sup>1</sup> / <sub>8</sub> "	630	60	123 lbs.	<b>6258</b>
<b>CWBX-S3</b>	69 <sup>9</sup> / <sub>16</sub> " x 19" x 17 <sup>1</sup> / <sub>8</sub> "	930	60	150 lbs.	<b>7537</b>
<b>CWBX-S4</b>	90 <sup>1</sup> / <sub>4</sub> " x 19" x 17 <sup>1</sup> / <sub>8</sub> "	1230	60	221 lbs.	<b>9491</b>

### All Remote Refrigerated Slim Drop-In Well Models with Remote Control Panel Feature:

Voltage: 120V, single phase.

Models Shipped with: Electronic temperature control, TXV valve (all shipped loose) and a soleoid valve attached to the well.

### OPTIONS (available at time of purchase only)

<b>EWC</b>	Additional Four Year Parts Only Warranty on the Compressor	<b>\$200</b>
------------	--	--------------

Slant Options –		
<b>CWB-S1SLANT</b>	Slant Option for CWBR-S1 and CWBX-S1	<b>318</b>
<b>CWB-S2SLANT</b>	Slant Option for CWBR-S2 and CWBX-S2	<b>340</b>
<b>CWB-S3SLANT</b>	Slant Option for CWBR-S3 and CWBX-S3	<b>363</b>
<b>CWB-S4SLANT</b>	Slant Option for CWBR-S4 and CWBX-S4	<b>384</b>

Gasket Options –		
<b>BEZELGASKET-S1</b>	Factory installed for CWBR-S1 and CWBX-S1	<b>\$ 93</b>
<b>BEZELGASKET-S2</b>	Factory installed for CWBR-S2 and CWBX-S2	<b>93</b>
<b>BEZELGASKET-S3</b>	Factory installed for CWBR-S3 and CWBX-S3	<b>122</b>
<b>BEZELGASKET-S4</b>	Factory installed for CWBR-S4 and CWBX-S4	<b>122</b>

### COUNTERTOP CUT-OUT DIMENSIONS – PAGE 31 ACCESSORIES – PAGE 34

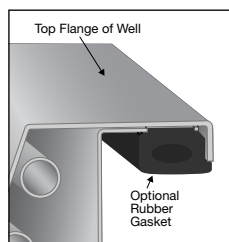
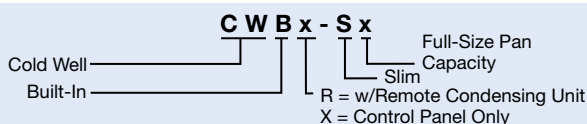

**BEZELGASKET-S1**  
Factory installed option (eliminates the need for silicone or other sealants)



**Refrigerated Drop-In Well Accessories** *(available for purchase at any time)*

Wells



CWB-2 with optional CWB-2SLANT, and accessory food pans and pan support bars

**PANS – TRIVETS** *(available for purchase at any time)*

<b>ST PAN 1/3</b>	Third-Size Stainless Steel Pan – 12¾"W x 6⅞"D x 2½"H	<b>\$ 68</b>
<b>ST PAN 1/2</b>	Half-Size Stainless Steel Pan – 12¾"W x 10⅞"D x 2½"H	<b>78</b>
<b>ST PAN 2</b>	Full-Size Stainless Steel Pan – 12¾"W x 20¾"D x 2½"H	<b>93</b>
<b>ST PAN 4</b>	Full-Size Stainless Steel Pan – 12¾"W x 20¾"D x 4"H	<b>117</b>
<b>HDW 6" PAN</b>	Full-Size Stainless Steel Pan – 12¾"W x 20¾"D x 6"H	<b>127</b>
<b>Wire Trivets Stainless –</b>		
<b>TRIVET (1/2)SS</b>	Half-Size – 10⅞"W x 7⅞"D	<b>\$126</b>
<b>TRIVET SS</b>	Full-Size – 10⅞"W x 18"D	<b>175</b>

**SUPPORT BARS – FALSE BOTTOMS**

*(available for purchase at any time)*

<b>CWB12BAR</b>	12" Pan Support Bar for Drop-In Ice or Refrigerated Wells	<b>\$24</b>
<b>CWB20BAR</b>	20" Pan Support Bar for Drop-In Ice or Refrigerated Wells	<b>28</b>
<b>False Bottom for Drop-In Refrigerated Wells (Perforated False Bottom Accessory, choose your appropriate pan size) –</b>		
<b>CWB-1FB</b>	For CWB-1 Series (1-Part Accessory)	<b>\$109</b>
<b>CWB-2FB</b>	For CWB-2 Series (1-Part Accessory)	<b>199</b>
<b>CWB-3FB</b>	For CWB-3 Series (2-Part Accessory)	<b>289</b>
<b>CWB-4FB</b>	For CWB-4 Series (2-Part Accessory)	<b>379</b>
<b>CWB-5FB</b>	For CWB-5 Series (3-Part Accessory)	<b>469</b>
<b>CWB-6FB</b>	For CWB-6 Series (3-Part Accessory)	<b>559</b>
<b>False Bottom for Slim Refrigerated Wells (choose your appropriate pan size) –</b>		
<b>1FBS8</b>	For CWB-S1 Series (1-Part Accessory)	<b>\$109</b>
<b>2FBS8</b>	For CWB-S2 Series (1-Part Accessory)	<b>199</b>
<b>3FBS8</b>	For CWB-S3 Series (2-Part Accessory)	<b>289</b>
<b>4FBS8</b>	For CWB-S4 Series (2-Part Accessory)	<b>379</b>



**Support Bars**  
Choose the appropriate kit for CWB or IWB series

**False Bottom Accessories**  
1-part, 2- or 3-part(s) depending on pan size

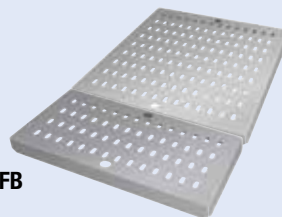

**CWB-3FB**

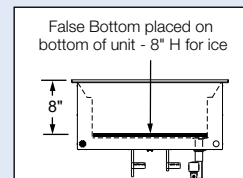

(CWB-1, -2, -3, -4, -5 or -6FB) for the CWB series

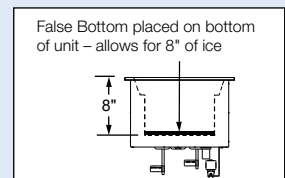

(1, 2, 3, or 4FBS8) for the CWB-S series

## R-290 Drop-In Frost Top Ordering Instructions

Cutaway of **FTBP-2**  
with accessory sheet pans

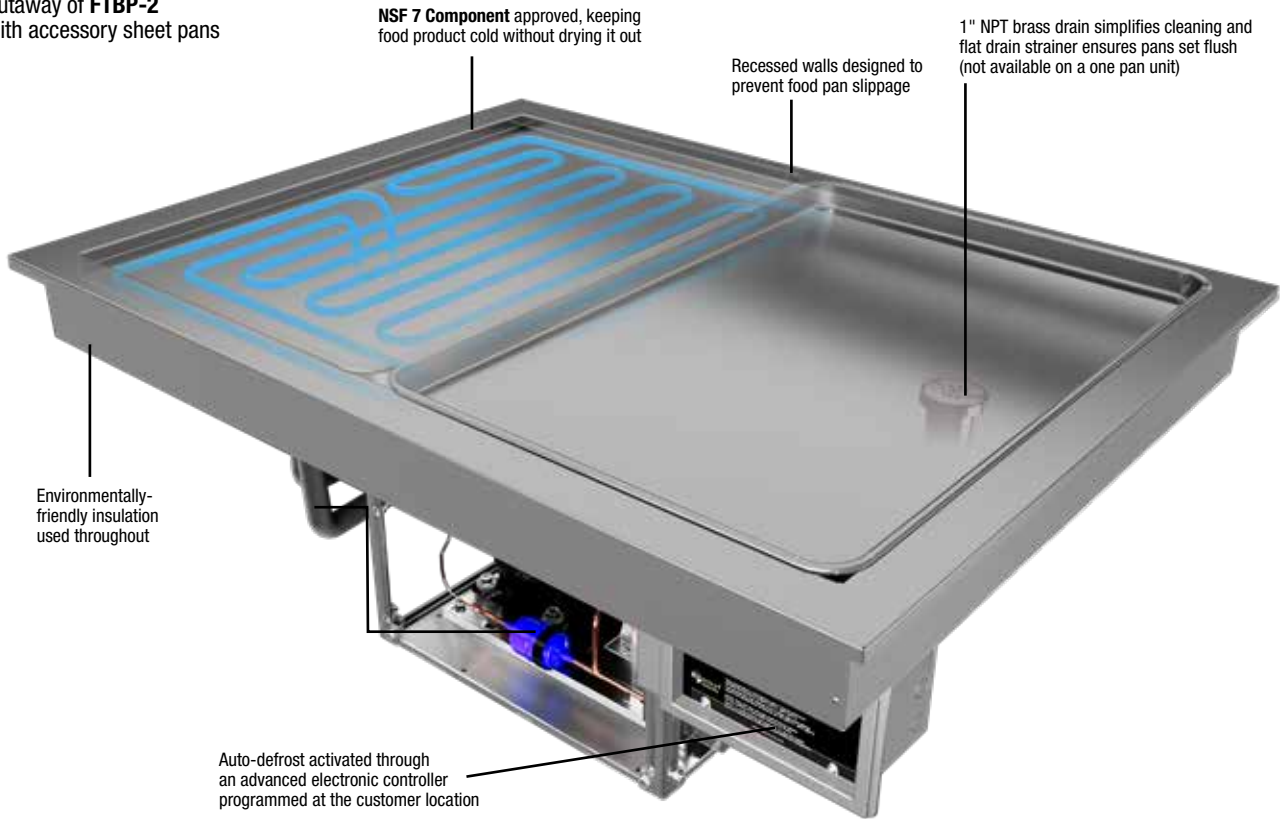

Wells

**Please specify the following with each order:**

- Number of Full-Size Sheet Pans Accommodated:**  
1-, 2- or 3-pan as rectangular sheet pans with a Slim or Standard configuration
- Depth of Model:** Standard configuration (28<sup>15</sup>/<sub>16</sub>"D) or Slim configuration (21<sup>1</sup>/<sub>16</sub>"D)
- Drain – 1" NPT Drain for FTBP-2, FTBP-3, FTBP-S2, FTBP-S3 only (drain plumbing to be installed per local codes)**
- Agency – UL, C-UL, NSF 7 Component**
- Electronic Control Assembly** can be mounted on either side of the Condensing Unit or remotely mounted up to 4' from the unit (cannot be mounted over the Condensing Unit)

**Option**

- Additional four year parts only warranty on the Compressor available at the time of unit purchase

**Accessories**

- Pans –**
  - A. Half-size sheet pan  
18"W x 13"D
  - B. Full-size sheet pan  
18"W x 26"D

**DROP-IN FROST TOP COUNTERTOP CUT-OUTS**

Model	Minimum Width	Maximum Width	Minimum Depth	Maximum Depth
FTBP-1	19 <sup>7</sup> / <sub>16</sub> "	20 <sup>1</sup> / <sub>8</sub> "	27 <sup>7</sup> / <sub>16</sub> "	28 <sup>1</sup> / <sub>8</sub> "
FTBP-2	37 <sup>3</sup> / <sub>8</sub> "	38"	27 <sup>5</sup> / <sub>16</sub> "	28"
FTBP-3	55 <sup>3</sup> / <sub>8</sub> "	56"	27 <sup>5</sup> / <sub>16</sub> "	28"
FTBP-S2	53 <sup>3</sup> / <sub>16</sub> "	54"	19 <sup>1</sup> / <sub>16</sub> "	20 <sup>1</sup> / <sub>8</sub> "
FTBP-S3	79 <sup>7</sup> / <sub>16</sub> "	79 <sup>7</sup> / <sub>8</sub> "	19 <sup>1</sup> / <sub>16</sub> "	20 <sup>1</sup> / <sub>8</sub> "



## R-290 Drop-In Frost Tops

Keep your self-serve products - beverages, snacks, hors d'oeuvres, side dishes, desserts and other quick turnaround items - in the perfect chill zone with Hatco R-290 Drop-In Frost Tops.

- Accommodates full-size sheet pans
- Units include a 1" brass drain (excluding one-pan units)
- Optimal insulation on sides and bottom to ensure better cold retention, and built with one of the most efficient condensing units on the market
- Auto-defrost is activated through an advanced electronic controller programmed at the customer location
- Available in a slim, lengthwise configuration to allow for easy, reachable access to products
- Condenser utilizes an environmentally friendly R-290 refrigerant, which has a 90% higher heat absorption capacity than other refrigerants, resulting in quicker temperature recovery and lower energy consumption



FTBP-2 with accessory sheet pans



FTBP-S2

### R-290 DROP-IN FROST TOPS AND DROP-IN SLIM FROST TOPS

Model	Dimensions W x D x H	Drain (1" Brass Drain)	HP	Hz	Watts	Plug	Approx. Ship Weight	List Price
FTBP-1	21 <sup>1</sup> / <sub>16</sub> " x 28 <sup>15</sup> / <sub>16</sub> " x 23 <sup>1</sup> / <sub>16</sub> "	None	1/3	50/60	333/364/396	NEMA 5-15P	132 lbs.	<b>\$7010</b>
FTBP-2	39" x 28 <sup>15</sup> / <sub>16</sub> " x 17 <sup>1</sup> / <sub>8</sub> "	Yes	1/3	50/60	333/364/396	NEMA 5-15P	170 lbs.	<b>7800</b>
FTBP-3	57" x 28 <sup>15</sup> / <sub>16</sub> " x 17 <sup>1</sup> / <sub>8</sub> "	Yes	1/3	50/60	333/364/396	NEMA 5-15P	213 lbs.	<b>8700</b>
<b>Slim</b>								
FTBP-S2	54 <sup>15</sup> / <sub>16</sub> " x 21 <sup>1</sup> / <sub>16</sub> " x 17 <sup>1</sup> / <sub>8</sub> "	Yes	1/3	50/60	333/364/396	NEMA 5-15P	182 lbs.	<b>\$7800</b>
FTBP-S3	80 <sup>3</sup> / <sub>16</sub> " x 21 <sup>1</sup> / <sub>16</sub> " x 17 <sup>1</sup> / <sub>8</sub> "	Yes	1/3	50/60	333/364/396	NEMA 5-15P	239 lbs.	<b>8700</b>

**All R-290 Drop-In Frost Top Models Feature:**

**Voltage:** 120V, single phase.

**Models Shipped with:** Electronic temperature control, condensing unit and compressor  
Consult factory for refrigerant specifications.

**NOTE:** The installation kit, including the intake bracket, duct clamp, flexible duct, and duct collar, will be shipped separately.

#### OPTIONS (available at time of purchase only)

<b>EWC</b>	Additional Four Year Parts Only Warranty on the Compressor Available at the Time of Unit Purchase	<b>\$200</b>
------------	---	--------------

#### ACCESSORIES (available for purchase at any time)

<b>ALUM PAN</b>	Half-Size Sheet Pan – 18"W x 13"D	<b>\$37</b>
<b>18" SHEET PAN</b>	Full-Size Sheet Pan – 18"W x 26"D	<b>52</b>

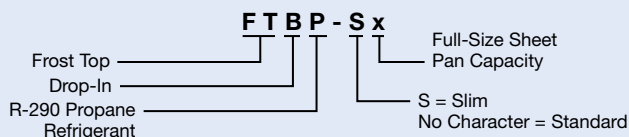



# Drop-In Frost Top Ordering Instructions

Cutaway of **FTB-3**  
with accessory sheet pans



**NSF 7 Component** approved, keeping food product cold without drying it out

Wells

**Please specify the following with each order:**

- 1. Number of Full-Size Sheet Pans Accommodated:**  
1-, 2- or 3-pan as rectangular sheet pans with a Slim or Standard configuration
- 2. Depth of Model:** Standard configuration (28<sup>5</sup>/<sub>16</sub>"D) or Slim configuration (21<sup>1</sup>/<sub>16</sub>"D)
- 3. Drain –** 1" NPT Drain for FTB-2, FTB-3, FTB-S2, FTB-S3 only (drain plumbing to be installed per local codes)
- 4. Agency –** UL, C-UL, NSF 7 Component
- 5. Electronic Control Assembly** can be mounted on either side of the Condensing Unit or remotely mounted up to 4' from the unit (cannot be mounted over the Condensing Unit)

**Option**

- 1.** Additional four year parts only warranty on the Compressor available at the time of unit purchase

**Accessories**

- 1. Pans –**
  - A. Half-size sheet pan  
18"W x 13"D
  - B. Full-size sheet pan  
18"W x 26"D

From below, you can see the condenser unit after being pulled out by the technician, allowing easy access and visibility to all service components



The sight glass gives an inside look into a usually closed system to determine if the refrigerant is low or if there is water in the system

**DROP-IN FROST TOP COUNTERTOP CUT-OUTS**

Model	Minimum Width	Maximum Width	Minimum Depth	Maximum Depth
<b>FTB-1</b>	19 <sup>7</sup> / <sub>16</sub> "	20 <sup>1</sup> / <sub>8</sub> "	27 <sup>7</sup> / <sub>16</sub> "	28"
<b>FTB-2</b>	37 <sup>3</sup> / <sub>8</sub> "	38"	27 <sup>5</sup> / <sub>16</sub> "	28"
<b>FTB-3</b>	55 <sup>3</sup> / <sub>8</sub> "	56"	27 <sup>5</sup> / <sub>16</sub> "	28"
<b>FTB-S2</b>	53 <sup>3</sup> / <sub>16</sub> "	54"	19 <sup>7</sup> / <sub>16</sub> "	20 <sup>1</sup> / <sub>8</sub> "
<b>FTB-S3</b>	79 <sup>3</sup> / <sub>16</sub> "	79 <sup>7</sup> / <sub>8</sub> "	19 <sup>7</sup> / <sub>16</sub> "	20 <sup>1</sup> / <sub>8</sub> "



## Drop-In Frost Tops

Convenience meets style with the Hatco Drop-In Frost Tops. Perfect for quick turn products on self-serve buffets. Ideal for snacks, hors d'oeuvre, side dishes, desserts... truly a unit for breakfast, lunch and dinner. Sturdy construction and easy clean-up while keeping things cool. Also available in a slim configuration, providing wider access to your food product.

- Accommodates full-size sheet pans
- Units include a 1" NPT (National Pipe Thread) brass drain (excluding one pan units) and refrigeration system
- Electronic adjustable temperature control can be mounted to either side of the condensing unit or remotely up to four feet from unit
- The condensing unit, mounted on the center of the unit, rotates 90° or 180°
- Mobile condensing unit may be moved in 6½" increments from end to center in the FTB-3, FTB-S2, -S3 units, and in 3" increments from end to center in the FTB-2 at installation
- Optimal insulation on sides and bottom to ensure better cold retention, and built with one of the most efficient condensing units on the market
- Auto-defrost is activated through an advanced electronic controller programmed at the customer location

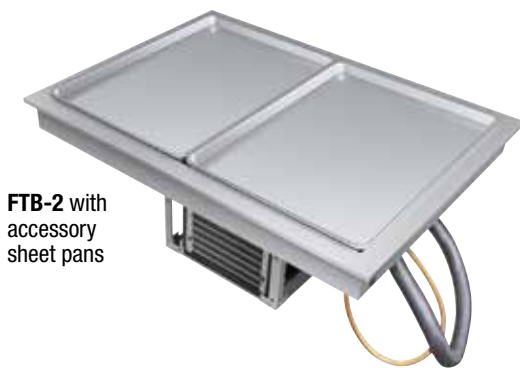

FTB-2 with accessory sheet pans



FTB-S2 with accessory sheet pans

### DROP-IN FROST TOPS AND DROP-IN SLIM FROST TOPS

Model	Dimensions W x D x H	Drain (1" NPT Brass Drain)	HP	Hz	Watts	Plug	Approx. Ship Weight	List Price
<b>FTB-1</b>	21 <sup>1</sup> / <sub>16</sub> " x 28 <sup>15</sup> / <sub>16</sub> " x 17 <sup>1</sup> / <sub>4</sub> "	None	1/2	60	300	NEMA 5-15P	132 lbs.	<b>\$7787</b>
<b>FTB-2</b>	39" x 28 <sup>15</sup> / <sub>16</sub> " x 17 <sup>1</sup> / <sub>4</sub> "	Yes	1/2	60	300	NEMA 5-15P	170 lbs.	<b>8670</b>
<b>FTB-3</b>	57" x 28 <sup>15</sup> / <sub>16</sub> " x 17 <sup>1</sup> / <sub>4</sub> "	Yes	1/2	60	300	NEMA 5-15P	213 lbs.	<b>9661</b>
<b>Slim</b>								
<b>FTB-S2</b>	54 <sup>15</sup> / <sub>16</sub> " x 21 <sup>1</sup> / <sub>16</sub> " x 17 <sup>1</sup> / <sub>4</sub> "	Yes	1/2	60	300	NEMA 5-15P	182 lbs.	<b>\$8759</b>
<b>FTB-S3</b>	80 <sup>3</sup> / <sub>16</sub> " x 21 <sup>1</sup> / <sub>16</sub> " x 17 <sup>1</sup> / <sub>4</sub> "	Yes	1/2	60	300	NEMA 5-15P	239 lbs.	<b>9816</b>

**All Drop-In Frost Top Models Feature:**

**Voltage:** 120V, single phase.

**Models Shipped with:** Electronic temperature control, condensing unit, compressor and flexible refrigerant lines to bottom of unit. Consult factory for refrigerant specifications.

#### OPTIONS (available at time of purchase only)

<b>EWC</b>	Additional Four Year Parts Only Warranty on the Compressor Available at the Time of Unit Purchase	<b>\$200</b>
------------	---	--------------

#### ACCESSORIES (available for purchase at any time)

<b>ALUM PAN</b>	Half-Size Sheet Pan – 18"W x 13"D	<b>\$37</b>
<b>18" SHEET PAN</b>	Full-Size Sheet Pan – 18"W x 26"D	<b>52</b>

#### COUNTERTOP CUT-OUT DIMENSIONS – PAGE 37

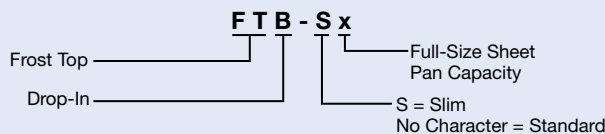

## Remote Drop-In Frost Top Ordering Instructions

Cutaway of **FTBR-3**  
with accessory sheet pans

**Frost Top with:**  
Temperature Probe

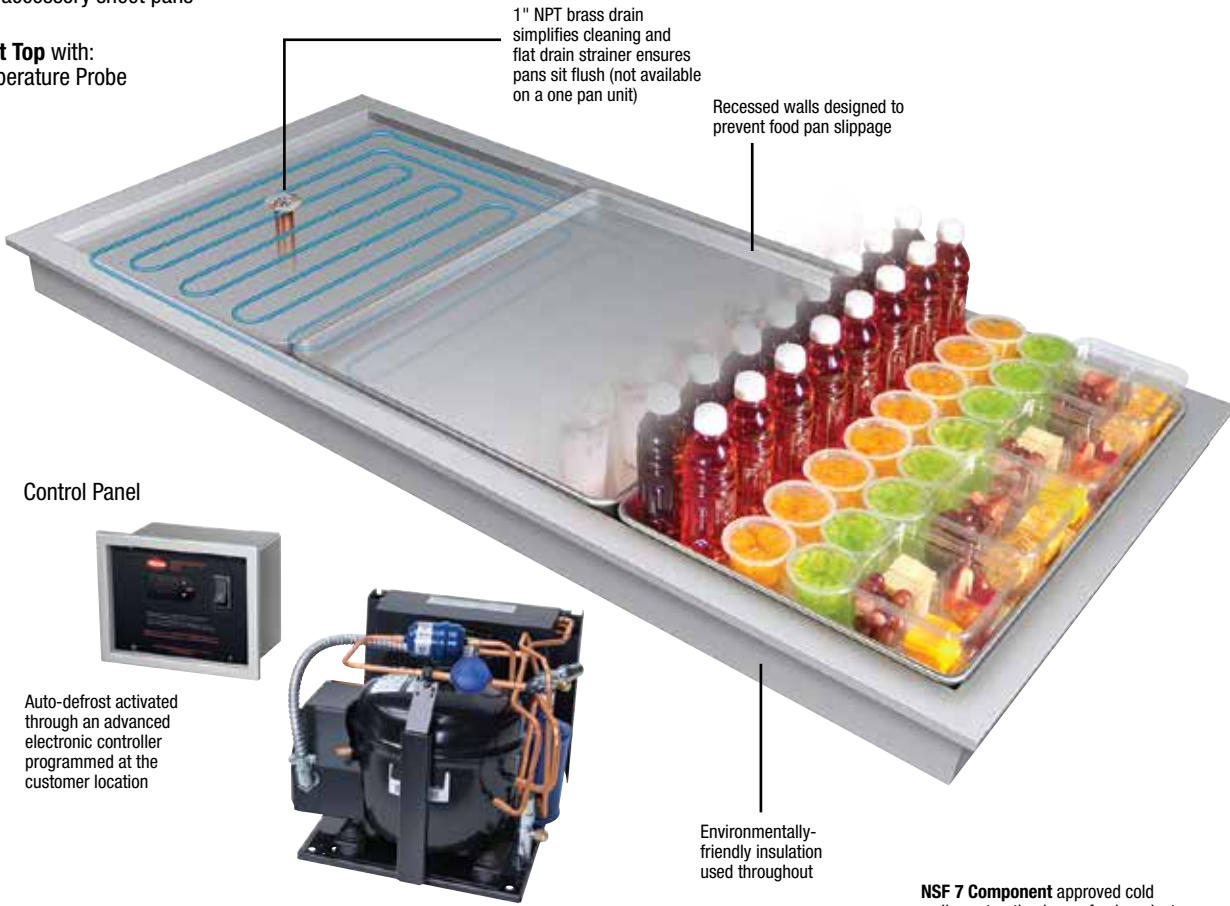

**FTBR:** Condensing Unit  
**FTBX:** No Condensing Unit

**Please specify the following with each order:**

- Number of Full-Size Sheet Pans Accommodated:**  
1-, 2- or 3-pan as rectangular sheet pans
- Depth of Model:** Standard configuration (28<sup>15</sup>/<sub>16</sub>"D)  
or Slim configuration (21<sup>1</sup>/<sub>16</sub>"D)
- Remote Refrigeration**  
**Note:** Shipped loose: Frost Top, Control Panel (Probe Wires are 9') and a TXV Valve  
A. FTBX without a Condensing Unit (Solenoid Valve attached to Frost Top)
- Agency** – UL, C-UL, NSF 7 Component

### Accessories

- Pans** –  
A. Half-size sheet pan  
18"W x 13"D  
B. Full-size sheet pan  
18"W x 26"D

### REMOTE DROP-IN FROST TOP COUNTERTOP CUT-OUTS

Model	Minimum Width	Maximum Width	Minimum Depth	Maximum Depth
<b>FTBR-1, FTBX-1</b>	27 <sup>1</sup> / <sub>16</sub> "	28"	19 <sup>7</sup> / <sub>16</sub> "	20 <sup>1</sup> / <sub>8</sub> "
<b>FTBR-2, FTBX-2</b>	37 <sup>3</sup> / <sub>8</sub> "	38"	27 <sup>5</sup> / <sub>16</sub> "	28"
<b>FTBR-3, FTBX-3</b>	55 <sup>3</sup> / <sub>8</sub> "	56"	27 <sup>5</sup> / <sub>16</sub> "	28"
<b>FTBR-S2, FTBX-S2</b>	53 <sup>3</sup> / <sub>16</sub> "	54"	19 <sup>1</sup> / <sub>16</sub> "	20 <sup>1</sup> / <sub>8</sub> "
<b>FTBR-S3, FTBX-S3</b>	79 <sup>1</sup> / <sub>16</sub> "	79 <sup>1</sup> / <sub>16</sub> "	19 <sup>1</sup> / <sub>16</sub> "	20 <sup>1</sup> / <sub>8</sub> "



## Remote Drop-In Frost Tops

Keeping pre-chilled beverages, snacks, hors d'oeuvres and side dishes cool and ready-to-serve, the Hatco Remote Drop-In Frost Tops offer additional flexibility with remote configurations. Also available in a Slim configuration, providing wider access to your customer.

- Accommodates full-size sheet pans
- Units include a 1" NPT (National Pipe Thread) brass drain (excluding one pan units)
- FTBR models include a condensing unit (shipped loose, can be field mounted up to 50 feet of tubing from unit) and a control panel (shipped loose - probe wires are 9 feet) for installing in more convenient or desirable locations
- FTBX models include a control panel (shipped loose - probe wires are 9 feet) but shipped without a condensing unit for the increased flexibility of multiple Frost Top configurations
- Easy serviceability with a sight glass, service valves, dryer and a receiver (FTBR models only)
- Auto-defrost is activated through an advanced electronic controller programmed at the customer location (FTBR models only)
- Optimal insulation on sides and bottom to ensure better cold retention, and built with one of the most efficient condensing units on the market

**FTBR-S2**  
with accessory  
sheet pans



**Frost Top** with a  
temperature  
probe, control  
panel and  
a condensing  
unit (both  
shipped loose)

**FTBX-1** (shipped  
without condensing unit)

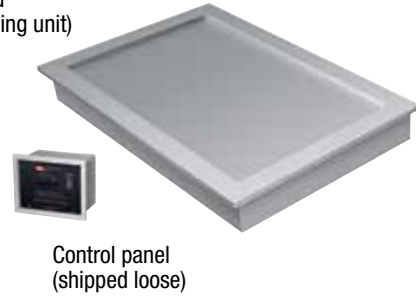

Control panel  
(shipped loose)

### REMOTE DROP-IN FROST TOPS – WITH CONDENSING UNIT AND CONTROL PANEL

Model	Dimensions W x D x H	HP	Approx. Ship Weight	List Price
<b>FTBR-1</b> <sup>o</sup>	28 <sup>15</sup> / <sub>16</sub> " x 21 <sup>1</sup> / <sub>16</sub> " x 8 <sup>5</sup> / <sub>8</sub> "	1/8	125 lbs.	<b>\$6988</b>
<b>FTBR-2</b>	39" x 28 <sup>15</sup> / <sub>16</sub> " x 8 <sup>5</sup> / <sub>8</sub> "	1/8	151 lbs.	<b>7871</b>
<b>FTBR-3</b>	57" x 28 <sup>15</sup> / <sub>16</sub> " x 8 <sup>5</sup> / <sub>8</sub> "	1/8	213 lbs.	<b>8862</b>
<b>Slim</b>				
<b>FTBR-S2</b>	54 <sup>15</sup> / <sub>16</sub> " x 21 <sup>1</sup> / <sub>16</sub> " x 8 <sup>5</sup> / <sub>8</sub> "	1/8	179 lbs.	<b>\$7960</b>
<b>FTBR-S3</b>	80 <sup>13</sup> / <sub>16</sub> " x 21 <sup>1</sup> / <sub>16</sub> " x 8 <sup>5</sup> / <sub>8</sub> "	1/8	230 lbs.	<b>9017</b>

<sup>o</sup> No drain

**All Remote Drop-In Frost Top Models Feature:**

**Voltage** – FTBR-1, -2, -3, -S2, -S3: 120V, 300 watts, 60 Hz, single phase.

**Models Shipped with:** Electronic temperature control, condensing unit and TXV valve (all shipped loose). Consult factory for refrigerant specifications.

### REMOTE DROP-IN FROST TOPS – WITH CONTROL PANEL

Model	Dimensions W x D x H	BTU/ Hour	Approx. Ship Weight	List Price
<b>FTBX-1</b> <sup>o</sup>	28 <sup>15</sup> / <sub>16</sub> " x 21 <sup>1</sup> / <sub>16</sub> " x 8 <sup>5</sup> / <sub>8</sub> "	330	85 lbs.	<b>\$5695</b>
<b>FTBX-2</b>	39" x 28 <sup>15</sup> / <sub>16</sub> " x 8 <sup>5</sup> / <sub>8</sub> "	630	138 lbs.	<b>6578</b>
<b>FTBX-3</b>	57" x 28 <sup>15</sup> / <sub>16</sub> " x 8 <sup>5</sup> / <sub>8</sub> "	930	220 lbs.	<b>7569</b>
<b>Slim</b>				
<b>FTBX-S2</b>	54 <sup>15</sup> / <sub>16</sub> " x 21 <sup>1</sup> / <sub>16</sub> " x 8 <sup>5</sup> / <sub>8</sub> "	630	130 lbs.	<b>\$6667</b>
<b>FTBX-S3</b>	80 <sup>13</sup> / <sub>16</sub> " x 21 <sup>1</sup> / <sub>16</sub> " x 8 <sup>5</sup> / <sub>8</sub> "	930	182 lbs.	<b>7724</b>

**All Remote Drop-In Frost Top Models Feature:**

**Voltage:** 120, single phase.

**Models Shipped with:** Electronic temperature control, TXV valve (shipped loose) and a solenoid valve attached to well.

### OPTIONS (available at time of purchase only)

<b>EWC</b>	Additional Four Year Extended Parts Only Warranty on the Compressor (FTBR only)	<b>\$200</b>
------------	--	--------------

### ACCESSORIES (available for purchase at any time)

<b>ALUM PAN</b>	Half-Size Sheet Pan – 18"W x 13"D	<b>\$37</b>
<b>18" SHEET PAN</b>	Full-Size Sheet Pan – 18"W x 26"D	<b>52</b>

### COUNTERTOP CUT-OUT DIMENSIONS – PAGE 39

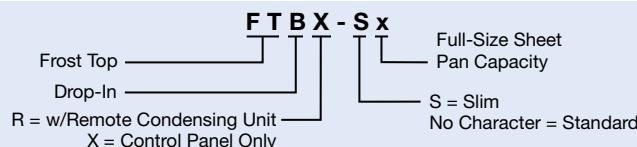



## Modular/Ganged Heated Wells (Full and 4/3-Size) Ordering Instructions

Cutaway of HWBI-5MA with accessory food pans and optional split control boxes

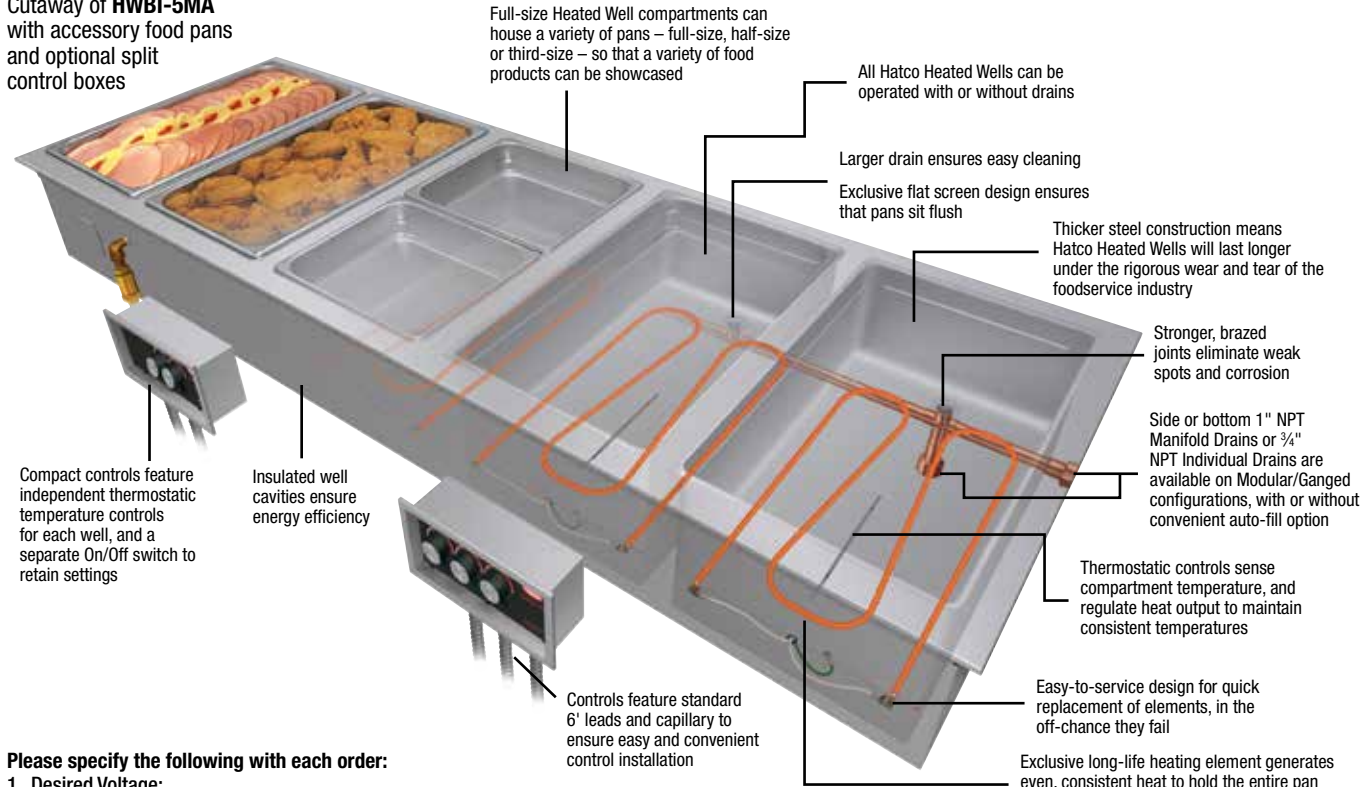

Please specify the following with each order:

- Desired Voltage:**
  - HWBI-1 Series (D, DA): 120, 208 or 240V, single phase
  - HWBLI-1, -2, -3, -4, -5, -6 Series (D, DA, M, MA): 120V, single phase
  - HWBI-2, -3, -4, -5, -6 Series (D, DA, M, MA): 208 or 240V, single or optional three phase
  - HWBI43-1(D, DA): 120, 208 or 240V, single phase
  - HWBI43-2, -3, -4, -5, -6 Series (D, DA, M, MA): 208 or 240V, single or optional three phase
- Desired Wattage:**
  - A. Standard Watt
  - B. Low Watt (120V only) and not available for HWBI43 Series)
- Number of Modular/Ganged Heated Wells Required:**
  - 1-, 2-, 3-, 4-, 5- or 6-pan
  - NOTE:** Modular/Ganged units are only offered as rectangular, full-size (12" x 20") as 4/3-size wells (12" x 27")
- Drain (with or without – choose drain below):**
  - A. Standard Individual Well 3/4" NPT Drain
  - B. Manifold 1" NPT Drain with side drain, field selectable left or right side (available on HWBI- or HWBLI-2, -3, -4, -5, -6 models only)
  - C. Manifold 1" NPT Drain with bottom drain, field selectable left or right well (available on HWBI- or HWBLI-2, -3, -4, -5, -6 models only)
- Auto-fill (with or without)**
- Bezel** allows an optional 27" depth for modular units to match Hatco CWB models in a countertop display (not available for HWBI43 Series)
- Agency:**
  - A. UL, C-UL
  - B. UL-EPH (sanitary listing)
- Control:**
  - A. Single Control Box (standard on all units)
  - B. Split Controls Boxes (optional on 4-, 5-, 6-pan units, not available in Canada)

### Accessories for Modular/Ganged Heated Wells

- Pan Support Bars:**
  - A. Standard or Slim configuration 12" or 20"
  - B. 4/3-size configuration 12"
- Adapters** to convert Modular/Ganged units to hold 4- or 7-quart round pans
- Stainless Steel Pans:**
  - A. Third-size (12 3/4"W x 6 7/8"D x 2 1/2"H)
  - B. Half-size (12 3/4"W x 10 3/8"D x 2 1/2"H)
  - C. Full-size at 2 1/2" deep (12 3/4"W x 20 3/4"D x 2 1/2"H)
  - D. Full-size at 4" deep (12 3/4"W x 20 3/4"D x 4"H)
  - E. Full-size at 6" deep (12 3/4"W x 20 3/4"D x 6"H)
- Valves:**
  - A. 3/4" or 1" NPT Ball Valve
  - B. 3/4" or 1" NPT Gate Valve
- Heated Well Covers** to convert Modular/Ganged units to heated shelves (not available for HWBI43 Series):
  - A. 1-Pan Heated Well Cover
  - B. 2-Pan Heated Well Cover

### DROP-IN MODULAR/GANGED HEATED WELLS COUNTERTOP CUT-OUTS

Model	Minimum Width	Maximum Width	Minimum Depth	Maximum Depth
HWBI-, HWBLI-1 Series	14 1/8"	14 1/2"	22 1/4"	22 5/8"
HWBI-, HWBLI-2 Series	28 1/8"	28 1/2"	22 1/4"	22 5/8"
HWBI-, HWBLI-3 Series	42 1/8"	42 1/2"	22 1/4"	22 5/8"
HWBI-, HWBLI-4 Series	56 1/8"	56 1/2"	22 1/4"	22 5/8"
HWBI-, HWBLI-5 Series	70 1/8"	70 1/2"	22 1/4"	22 5/8"
HWBI-, HWBLI-6 Series	84 1/8"	84 1/2"	22 1/4"	22 5/8"
<b>4/3-Size</b>				
HWBI43-1 Series	14 3/16"	14 3/8"	29 1/8"	29 3/8"
HWBI43-2 Series	28 3/16"	28 3/8"	29 1/8"	29 3/8"
HWBI43-3 Series	42 3/16"	42 3/8"	29 1/8"	29 3/8"
HWBI43-4 Series	56 3/16"	56 3/8"	29 1/8"	29 3/8"
HWBI43-5 Series	70 3/16"	70 3/8"	29 1/8"	29 3/8"
HWBI43-6 Series	84 3/16"	84 3/8"	29 1/8"	29 3/8"

### ACCESSORIES – PAGES 47, 58-59



From the top, the modular design allows the Modular/Ganged Heated Well to appear as one integrated unit. From below, you will see separate covers, with easy, independent access to each one. This makes installation and service easy

## Modular/Ganged Heated Wells

Hatco Modular/Ganged Heated Wells are full-size units that are grouped together in a modular fashion to provide customers with a complete steam table contained within one piece of equipment for a clean, integrated look.

- Full-size, insulated wells available in 1- to 6-ganged units in either standard or low wattages
- Individual thermostatic controls for each well provide the ultimate in temperature regulation
- 6' conduit is standard for convenient placement of controls

- Wells empty quickly and easily with a manifold drain option
- Auto-fill option to automatically fill and replenish water without user maintenance and intervention
- Separate well assemblies with independent access to each one for easy service

**HWBLI-5MA** with accessory food pans and standard single control box



### LOW WATT DROP-IN MODULAR/GANGED FULL-SIZE RECTANGULAR WELLS – INSULATED – TOP MOUNT

Model	Dimensions (W x D x H)	Watts	Approx. Ship Weight	List Price
HWBLI-1	15½" x 23¾" x 9¾"	750	38 lbs.	\$ 1521
HWBLI-1D	15½" x 23¾" x 9¾"	750	36 lbs.	1637
HWBLI-1DA	15½" x 23¾" x 9¾"	750	38 lbs.	2314
HWBLI-2	29½" x 23¾" x 9¾"	1500	82 lbs.	3216
HWBLI-2D	29½" x 23¾" x 9¾"	1500	85 lbs.	3382
HWBLI-2DA <sup>ⓐ</sup>	29½" x 23¾" x 9¾"	1500	87 lbs.	4042
HWBLI-2M	29½" x 23¾" x 9¾"	1500	84 lbs.	3459
HWBLI-2MA	29½" x 23¾" x 9¾"	1500	85 lbs.	4339
HWBLI-3	43½" x 23¾" x 9¾"	2250	106 lbs.	4012
HWBLI-3D	43½" x 23¾" x 9¾"	2250	110 lbs.	4312
HWBLI-3DA <sup>ⓐ</sup>	43½" x 23¾" x 9¾"	2250	114 lbs.	4637
HWBLI-3M	43½" x 23¾" x 9¾"	2250	105 lbs.	4585
HWBLI-3MA	43½" x 23¾" x 9¾"	2250	124 lbs.	5465
HWBLI-4	57½" x 23¾" x 9¾"	3000	134 lbs.	5204
HWBLI-4D	57½" x 23¾" x 9¾"	3000	155 lbs.	5744
HWBLI-4DA <sup>ⓐ</sup>	57½" x 23¾" x 9¾"	3000	133 lbs.	6403
HWBLI-4M	57½" x 23¾" x 9¾"	3000	148 lbs.	6200
HWBLI-4MA	57½" x 23¾" x 9¾"	3000	141 lbs.	7081
HWBLI-5	71½" x 23¾" x 9¾"	3750	167 lbs.	6239
HWBLI-5D	71½" x 23¾" x 9¾"	3750	166 lbs.	7151
HWBLI-5DA <sup>ⓐ</sup>	71½" x 23¾" x 9¾"	3750	167 lbs.	7827
HWBLI-5M	71½" x 23¾" x 9¾"	3750	188 lbs.	7749
HWBLI-5MA	71½" x 23¾" x 9¾"	3750	193 lbs.	8607
HWBLI-6	85½" x 23¾" x 9¾"	4500	194 lbs.	8082
HWBLI-6D	85½" x 23¾" x 9¾"	4500	203 lbs.	8807
HWBLI-6DA <sup>ⓐ</sup>	85½" x 23¾" x 9¾"	4500	200 lbs.	9437
HWBLI-6M	85½" x 23¾" x 9¾"	4500	200 lbs.	9626
HWBLI-6MA	85½" x 23¾" x 9¾"	4500	200 lbs.	10462

<sup>ⓐ</sup> Auto-fill located on left control only and fills left-hand well. To fill all wells, drains must be connected with external manifold by installer.

#### All Low Watt Drop-In Modular/Ganged Full-Size Rectangular Heated Well Models Feature:

Voltage: HWBLI-1DA, 2, -3, -4, -5, -6 Series: 120V, single phase.

Models Shipped with: EZ locking hardware for installation and remote thermostats with flexible conduits and lighted power switches.

#### OPTIONS (available at time of purchase only)

HWBI-SIDE	Copper Manifold Drain with side exit (not available on HWBLI-1)	No Charge
HWBI-BOTTOM	Copper Manifold Drain with bottom exit (not available on HWBLI-1)	No Charge
HWBLI-CORD-2	Cord for HWBLI-2 (single phase)	\$112
HWBLI-CORD-3	Cord for HWBLI-3 (single phase)	205
OS-BEZEL27	27" deep Bezel for Modular unit to match Hatco CWB in a countertop display	No Charge
COND-3	36" Flexible Conduit in lieu of 72" standard (For split control panel only)	No Charge



#### Gasket Options –

BEZELGASKET-1	Factory installed for HWBLI-1	\$ 121
BEZELGASKET-2	Factory installed for HWBLI-2	121
BEZELGASKET-3	Factory installed for HWBLI-3	158
BEZELGASKET-4	Factory installed for HWBLI-4	158
BEZELGASKET-5	Factory installed for HWBLI-5	170
BEZELGASKET-6	Factory installed for HWBLI-6	170

#### Modular/Ganged Heated Wells Controls\*

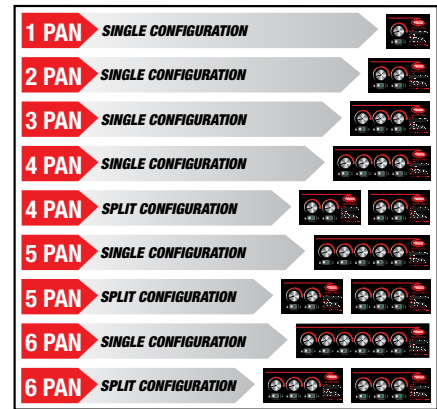

\*4-, 5-, 6-pan units: Single control box is standard. If optional split control boxes are desired, it must be specified at order (for Canada, split control boxes not available).

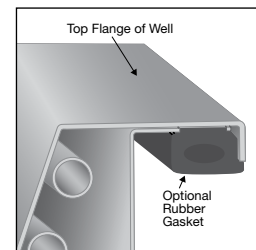

**BEZELGASKET-1**  
Factory installed option (eliminates the need for silicone or other sealants)

**NOTE:** Split Control Configurations are not available in Canada.

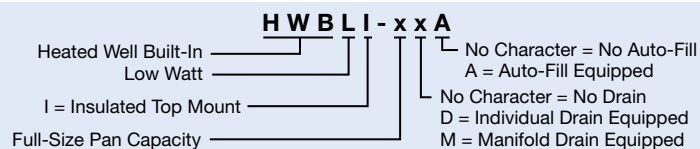

**COUNTERTOP CUT-OUT DIMENSIONS – PAGE 41**  
**ACCESSORIES – PAGES 47, 58-59**

## Modular/Ganged Heated Wells – Continued

### STANDARD WATT DROP-IN MODULAR/GANGED FULL-SIZE RECTANGULAR WELLS – INSULATED – TOP MOUNT

Model	Dimensions W x D x H	Watts	Approx. Ship Weight	List Price
HWBI-1	15½" x 23¾" x 9⅝"	1215	34 lbs.	\$ 1521
HWBI-1D	15½" x 23¾" x 9⅝"	1215	38 lbs.	1637
HWBI-1DA	15½" x 23¾" x 9⅝"	1215	38 lbs.	2314
HWBI-2	29½" x 23¾" x 9⅝"	2415	73 lbs.	3216
HWBI-2D	29½" x 23¾" x 9⅝"	2415	77 lbs.	3382
HWBI-2DA	29½" x 23¾" x 9⅝"	2415	87 lbs.	4042
HWBI-2M	29½" x 23¾" x 9⅝"	2415	74 lbs.	3459
HWBI-2MA	29½" x 23¾" x 9⅝"	2415	85 lbs.	4339
HWBI-3	43½" x 23¾" x 9⅝"	3615	103 lbs.	4012
HWBI-3D	43½" x 23¾" x 9⅝"	3615	114 lbs.	4312
HWBI-3DA	43½" x 23¾" x 9⅝"	3615	114 lbs.	4637
HWBI-3M	43½" x 23¾" x 9⅝"	3615	108 lbs.	4585
HWBI-3MA	43½" x 23¾" x 9⅝"	3615	112 lbs.	5465
HWBI-4	57½" x 23¾" x 9⅝"	4815	132 lbs.	5204
HWBI-4D	57½" x 23¾" x 9⅝"	4815	136 lbs.	5744
HWBI-4DA	57½" x 23¾" x 9⅝"	4815	133 lbs.	6403
HWBI-4M	57½" x 23¾" x 9⅝"	4815	138 lbs.	6200
HWBI-4MA	57½" x 23¾" x 9⅝"	4815	138 lbs.	7081
HWBI-5	71½" x 23¾" x 9⅝"	6015	167 lbs.	6239
HWBI-5D	71½" x 23¾" x 9⅝"	6015	167 lbs.	7151
HWBI-5DA	71½" x 23¾" x 9⅝"	6015	167 lbs.	7827
HWBI-5M	71½" x 23¾" x 9⅝"	6015	167 lbs.	7749
HWBI-5MA	71½" x 23¾" x 9⅝"	6015	184 lbs.	8607
HWBI-6	85½" x 23¾" x 9⅝"	7215	189 lbs.	8082
HWBI-6D	85½" x 23¾" x 9⅝"	7215	189 lbs.	8807
HWBI-6DA	85½" x 23¾" x 9⅝"	7215	193 lbs.	9437
HWBI-6M	85½" x 23¾" x 9⅝"	7215	189 lbs.	9626
HWBI-6MA	85½" x 23¾" x 9⅝"	7215	195 lbs.	10462

Auto-fill located on left control only and fills left-hand well. To fill all wells, drains must be connected with external manifold by installer.

#### All Standard Watt Drop-In Modular/Ganged Full-Size Rectangular Heated Well Models Feature:

Voltage: HWBI-1 Series: 120, 208 or 240V, single phase.

HWBI-2, -3, -4, -5, -6 Series: 208 or 240V, single phase or optional three phase.

Models Shipped with: EZ locking hardware for installation and remote thermostats with 6' flexible conduits and lighted power switches.



HWBI-3MA with accessory food pans and optional cord for HWBI-3

#### Modular/Ganged Heated Wells Controls\*

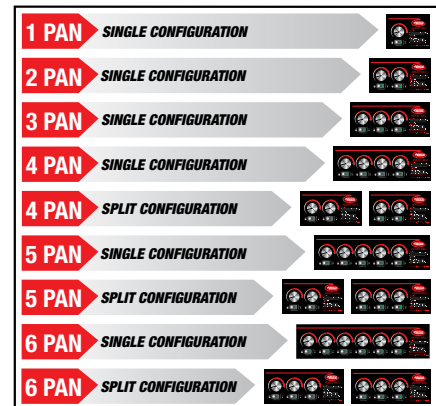

\*4-, 5-, 6-pan units: Single control box is standard. If optional split control boxes are desired, it must be specified at order (for Canada, split control boxes not available).

#### DROP-IN MODULAR/GANGED 3 Ø AMP RATINGS

Model	208V/3 Ø Amps	240V/3 Ø Amps
HWBI-2	10.1	8.7
HWBI-3	10.1	8.8
HWBI-4	15.8	13.7
HWBI-5	20.1	17.4
HWBI-6	20.1	17.4

#### OPTIONS (available at time of purchase only)

HWBI-3PH	Three-Phase Wiring (not available on HWBI-1 series)	No Charge
HWBI-SIDE	Copper Manifold Drain with side exit (not available on HWBI-1)	No Charge
HWBI-BOTTOM	Copper Manifold Drain with bottom exit (not available on HWBI-1)	No Charge
HWBI-CORD-1, -2	Cord for HWBI-1, -2 (single phase)	\$103
HWBI-CORD-3, -4	Cord for HWBI-3, -4 (single phase/single control box only)	205
HWBI-CORD-5, -6	Cord for HWBI-5, -6 (single phase/single control box only)	395
OS-BEZEL27	27" deep Bezel for Modular unit to match Hatco CWB in a countertop display	No Charge
COND-3	36" Flexible Conduit in lieu of 72" standard (For split control panel only)	No Charge



#### Gasket Options –

BEZELGASKET-1	Factory installed for HWBI-1	\$ 87
BEZELGASKET-2	Factory installed for HWBI-2	87
BEZELGASKET-3	Factory installed for HWBI-3	114
BEZELGASKET-4	Factory installed for HWBI-4	114
BEZELGASKET-5	Factory installed for HWBI-5	122
BEZELGASKET-6	Factory installed for HWBI-6	122

**NOTE:** Split Control Configurations are not available in Canada.

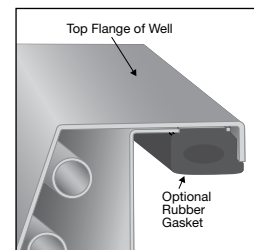

#### BEZELGASKET-1

Factory installed option (eliminates the need for silicone or other sealants)

#### HWBI - x x A

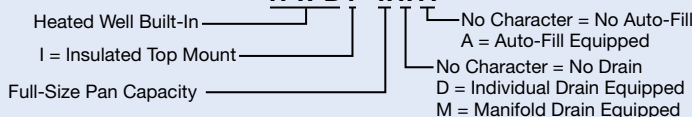

COUNTERTOP CUT-OUT DIMENSIONS – PAGE 41  
ACCESSORIES – PAGES 47, 58-59



## Drop-In Modular/Ganged 4/3-Size Heated Wells

Hatco Modular/Ganged 4/3-Size Heated Wells maintain hot food at safe-serving temperatures, with better quality construction, longer holding times and more accurate temperatures. A deeper single unit can hold the equivalent of 4 third-size pans.

Choose the number of wells, from 1 to 6 unit configurations, as well as voltage, auto-fill, controls and drain options. Each well has its own individual control to regulate the temperature of each food offering.

- Longer holding times with more accurate temperatures
- Separate lighted On/Off rocker switch and temperature dial for easy operation

- 50% larger drain with flat screen simplifies cleaning and holds pans level
- Unique design allows quick change of element or thermostat if needed
- EZ locking hardware for quick installation
- Stainless steel construction and solid brazed drain fitting joints for durability
- A 6" (1829 mm) conduit is included for convenient placement of controls

### DROP-IN MODULAR/GANGED 4/3-SIZE RECTANGULAR WELLS – INSULATED – TOP MOUNT

Model	Dimensions W x D x H	Voltage	Watts	Approx. Ship Weight	List Price
HWBI43-1	15½" x 30¾" x 9½"	208 or 240	1215	42 lbs.	\$ 2144
HWBI43-1D	15½" x 30¾" x 9½"	208 or 240	1215	42 lbs.	2207
HWBI43-1DA	15½" x 30¾" x 9½"	208 or 240	1215	47 lbs.	3000
HWBI43-2	29½" x 30¾" x 9½"	208 or 240	2415	88 lbs.	3576
HWBI43-2D	29½" x 30¾" x 9½"	208 or 240	2415	96 lbs.	3708
HWBI43-2DA*	29½" x 30¾" x 9½"	208 or 240	2415	95 lbs.	4531
HWBI43-2M	29½" x 30¾" x 9½"	208 or 240	2415	82 lbs.	4067
HWBI43-2MA	29½" x 30¾" x 9½"	208 or 240	2415	98 lbs.	4891
HWBI43-3	43½" x 30¾" x 9½"	208 or 240	3615	115 lbs.	4883
HWBI43-3D	43½" x 30¾" x 9½"	208 or 240	3615	112 lbs.	5077
HWBI43-3DA*	43½" x 30¾" x 9½"	208 or 240	3615	124 lbs.	5876
HWBI43-3M	43½" x 30¾" x 9½"	208 or 240	3615	135 lbs.	5488
HWBI43-3MA	43½" x 30¾" x 9½"	208 or 240	3615	135 lbs.	6290
HWBI43-4	57½" x 30¾" x 9½"	208 or 240	4815	166 lbs.	6433
HWBI43-4D	57½" x 30¾" x 9½"	208 or 240	4815	152 lbs.	6692
HWBI43-4DA*	57½" x 30¾" x 9½"	208 or 240	4815	149 lbs.	7493
HWBI43-4M	57½" x 30¾" x 9½"	208 or 240	4815	154 lbs.	7156
HWBI43-4MA	57½" x 30¾" x 9½"	208 or 240	4815	180 lbs.	7957
HWBI43-5	71½" x 30¾" x 9½"	208 or 240	6015	197 lbs.	7838
HWBI43-5D	71½" x 30¾" x 9½"	208 or 240	6015	186 lbs.	8173
HWBI43-5DA*	71½" x 30¾" x 9½"	208 or 240	6015	187 lbs.	8998
HWBI43-5M	71½" x 30¾" x 9½"	208 or 240	6015	186 lbs.	8703
HWBI43-5MA	71½" x 30¾" x 9½"	208 or 240	6015	203 lbs.	9528
HWBI43-6	85½" x 30¾" x 9½"	208 or 240	7215	214 lbs.	9360
HWBI43-6D	85½" x 30¾" x 9½"	208 or 240	7215	214 lbs.	9785
HWBI43-6DA*	85½" x 30¾" x 9½"	208 or 240	7215	217 lbs.	10646
HWBI43-6M	85½" x 30¾" x 9½"	208 or 240	7215	214 lbs.	10471
HWBI43-6MA	85½" x 30¾" x 9½"	208 or 240	7215	249 lbs.	11325



HWBI43-3DA with  
- 4 third-size pans,  
- 2 half-size pans and 1 third-size pan  
- 1 full-size pan and 1 third-size pan

### Modular/Ganged Heated Wells Controls\*

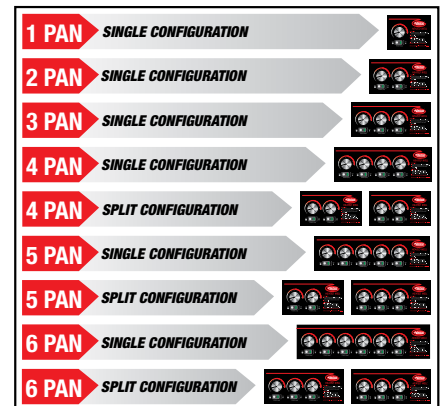

\* 4-, 5-, 6-pan units: Single control box is standard. If optional split control boxes are desired, it must be specified at order (for Canada, split control boxes not available).

⊗ Auto-fill located on left control only and fills left-hand well. To fill all wells, drains must be connected with external manifold by installer.

**All Drop-In Modular/Ganged 4/3-Size Rectangular Heated Well Models Feature:**  
Phase: HWBI43-1 Series: Single only. HWBI43-2, -3, -4, -5, -6 Series: Single or optional three phase.  
Models Shipped with: EZ locking hardware for installation and remote thermostats with 72" flexible conduits and lighted power switches.

**NOTE: Split Control Configurations are not available in Canada.**

**COUNTERTOP CUT-OUT DIMENSIONS – PAGE 41  
ACCESSORIES – PAGES 47, 58-59**

### OPTIONS (available at time of purchase only)

HWBI-3PH	Three-Phase Wiring (not available on HWBI43-1 series)	No Charge
HWBI-SIDE	Copper Manifold Drain with side exit (not available on HWBI43-1)	No Charge
HWBI-BOTTOM	Copper Manifold Drain with bottom exit (not available on HWBI43-1)	No Charge
HWBI43-CORD-1, -2	Cord for HWBI43-1, -2 (single phase)	\$112
HWBI43-CORD-3, -4	Cord for HWBI43-3, -4 (single phase/single control box only)	205
HWBI43-CORD-5, -6	Cord for HWBI43-5, -6 (single phase/single control box only)	395
COND-3	36" Flexible Conduit in lieu of 72" standard (For split control panel only)	No Charge



### Gasket Options –

BEZELGASKET-1	Factory installed for HWBI43-1	\$ 87
BEZELGASKET-2	Factory installed for HWBI43-2	87
BEZELGASKET-3	Factory installed for HWBI43-3	114
BEZELGASKET-4	Factory installed for HWBI43-4	114
BEZELGASKET-5	Factory installed for HWBI43-5	122
BEZELGASKET-6	Factory installed for HWBI43-6	122

**HWBI43 - x x A**

Heated Well Built-In \_\_\_\_\_

I = Insulated Top Mount \_\_\_\_\_

43 = 4/3-Size Depth \_\_\_\_\_

No Character = Full-Size Depth only

No Character = No Auto-Fill  
A = Auto-Fill Equipped  
No Character = No Drain  
D = Individual Drain Equipped  
M = Manifold Drain Equipped  
Full-Size Pan Capacity



## Modular/Ganged Slim Heated Wells Ordering Instructions

Cutaway of **HWBI-S4MA** with accessory food pans and standard single controls

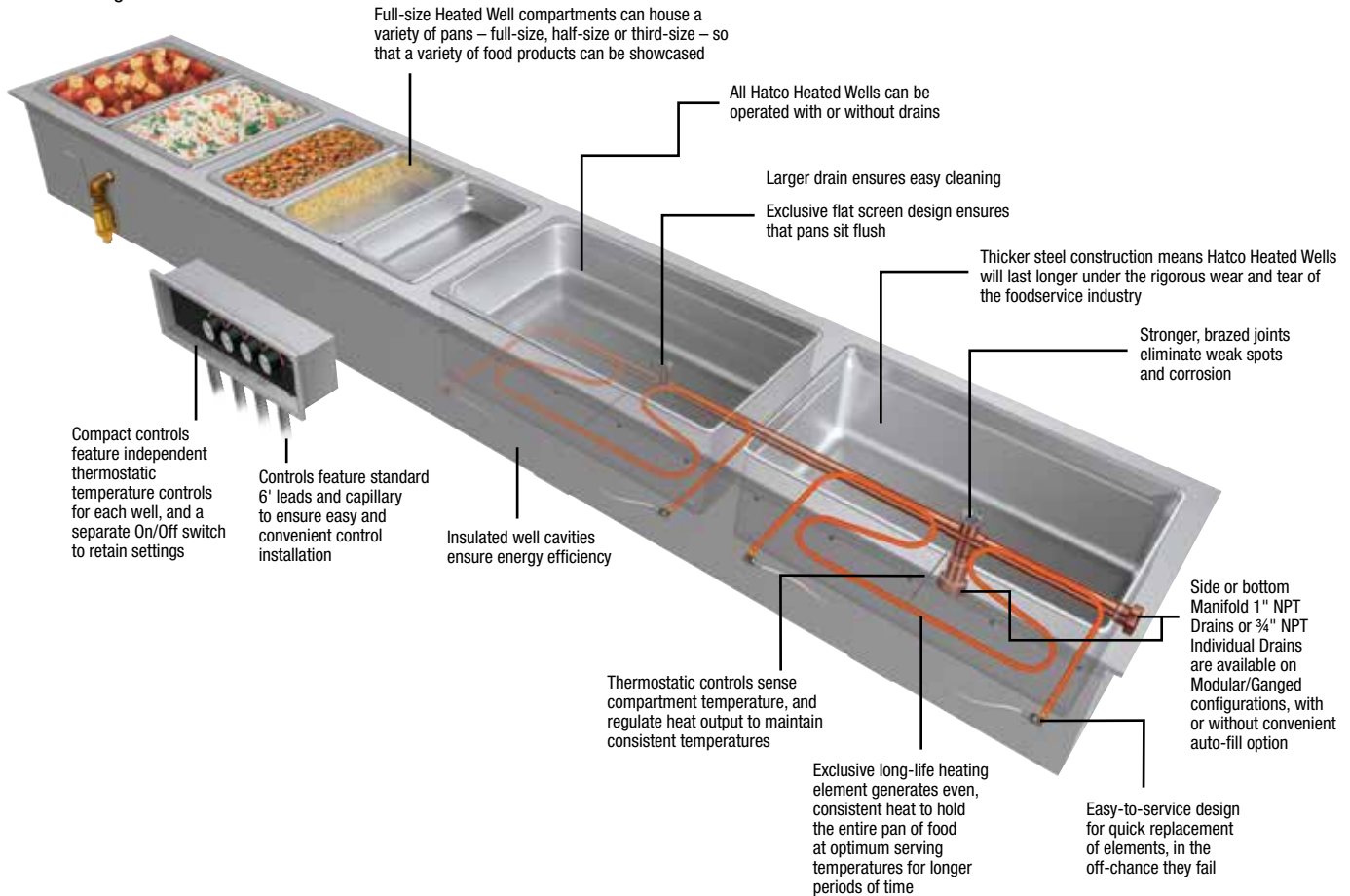

**Please specify the following with each order:**

- 1. Desired Voltage:** 208 or 240V
  - A. Single phase (standard)
  - B. Three phase (optional)
- 2. Number of Modular/Ganged Slim Heated Wells Required:** 2-, 3-, 4-pan  
**NOTE:** Modular/Ganged Slim units are only offered as rectangular, full-size (12" x 20") but placed lengthwise
- 3. Drain** (with or without – choose drain below):
  - A. Standard Individual Well 3/4" NPT Drain
  - B. Manifold 1" NPT Drain with side drain, field selectable left or right side
  - C. Manifold 1" NPT Drain with bottom drain, field selectable left or right well
- 4. Auto-fill** (with or without)
- 5. Bezel** allows an optional 19" D for modular units to match Hatco Refrigerated Slim Drop-In models in a countertop display
- 6. Agency:**
  - A. UL
  - B. UL-EPH (sanitary listing)
- 7. Control:**
  - A. Single Control Box (standard on all units)
  - B. Split Control Boxes (optional on 4-pan units, not available in Canada)

**Accessories for Modular/Ganged Slim Heated Wells**

- 1. Pan Support Bars:** 12" or 20"
- 2. Adapters** to convert Modular/Ganged Slim units to hold 4- or 7-quart round pans
- 3. Stainless Steel Pans:**
  - A. Third-size at 2 1/2" deep (12 3/4"W x 6 7/8"D x 2 1/2"H)
  - B. Half-size at 2 1/2" deep (12 3/4"W x 10 3/8"D x 2 1/2"H)
  - C. Full-size at 2 1/2" deep (12 3/4"W x 20 3/4"D x 2 1/2"H)
  - D. Full-size at 4" deep (12 3/4"W x 20 3/4"D x 4"H)
  - E. Full-size at 6" deep (12 3/4"W x 20 3/4"D x 6"H)
- 4. Valves:**
  - A. 3/4" or 1" NPT Ball Valve
  - B. 3/4" or 1" NPT Gate Valve
- 5. Heated Well Covers** to convert Slim Modular/Ganged units to heated shelves:
  - A. 1-Pan Heated Well Cover

**DROP-IN MODULAR/GANGED SLIM HEATED WELLS COUNTERTOP CUT-OUTS**

Model	Minimum Width	Maximum Width	Minimum Depth	Maximum Depth
<b>HWBI-S2 Series</b>	44 1/8"	44 3/8"	14 1/4"	14 1/2"
<b>HWBI-S3 Series</b>	66 1/8"	66 3/8"	14 1/4"	14 1/2"
<b>HWBI-S4 Series</b>	88 1/8"	88 3/8"	14 1/4"	14 1/2"

**ACCESSORIES – PAGES 47, 58-59**

## Modular/Ganged Slim Heated Wells

Hatco Modular/Ganged Slim Heated Wells are full-sized units that are grouped together in a modular fashion but placed lengthwise. This provides customers with a complete steam table within easy reach. Select the configuration that's right for your foodservice operation.

- Full-size, insulated wells available in 2- to 4-modular/ganged units
- Individual thermostatic controls for each well provide the ultimate in temperature regulation
- 6' conduit is standard for convenient placement of controls

- Wells empty quickly and easily with a manifold drain option
- Auto-fill option to automatically fill and replenish water without user maintenance and intervention
- Separate well assemblies with independent access to each one for easy service



HWBI-S4MA with accessory food pans and optional split control boxes

### DROP-IN MODULAR/GANGED SLIM RECTANGULAR WELLS – INSULATED – TOP MOUNT

Model	Dimensions W x D x H	Watts	Approx. Ship Weight	List Price
HWBI-S2	45½" x 15½" x 9¼"	2415	83 lbs.	\$3481
HWBI-S2D	45½" x 15½" x 9¼"	2415	81 lbs.	3638
HWBI-S2DA <sup>Ⓢ</sup>	45½" x 15½" x 9¼"	2415	84 lbs.	4298
HWBI-S2M	45½" x 15½" x 9¼"	2415	86 lbs.	3769
HWBI-S2MA	45½" x 15½" x 9¼"	2415	90 lbs.	4644
HWBI-S3	67½" x 15½" x 9¼"	3615	118 lbs.	4394
HWBI-S3D	67½" x 15½" x 9¼"	3615	115 lbs.	4713
HWBI-S3DA <sup>Ⓢ</sup>	67½" x 15½" x 9¼"	3615	125 lbs.	5356
HWBI-S3M	67½" x 15½" x 9¼"	3615	115 lbs.	5011
HWBI-S3MA	67½" x 15½" x 9¼"	3615	125 lbs.	5888
HWBI-S4	89½" x 15½" x 9¼"	4815	154 lbs.	5820
HWBI-S4D	89½" x 15½" x 9¼"	4815	155 lbs.	6309
HWBI-S4DA <sup>Ⓢ</sup>	89½" x 15½" x 9¼"	4815	160 lbs.	6951
HWBI-S4M	89½" x 15½" x 9¼"	4815	154 lbs.	6786
HWBI-S4MA	89½" x 15½" x 9¼"	4815	153 lbs.	7638

<sup>Ⓢ</sup> Auto-fill located on left control only and fills left-hand well. To fill all wells, drains must be connected with external manifold by installer.

#### All Drop-In Modular Slim Rectangular Heated Well Models Feature:

Voltage: HWBI-S2, -S3, -S4 Series: 208 or 240V, single phase or optional three phase.

Models Shipped with: EZ locking hardware for installation and remote thermostats with lighted power switches.

#### Modular/Ganged Slim Heated Wells Controls\*

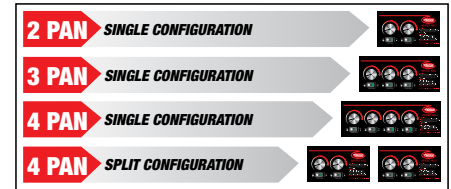

\* 4-pan units: Single control box is standard. If optional split control boxes are desired, it must be specified at order (for Canada, split control boxes not available).

#### OPTIONS (available at time of purchase only)

HWBI-3PH	Three-Phase Wiring (field convertible)	No Charge
HWBI-SIDE	Copper Manifold Drain with side exit	No Charge
HWBI-BOTTOM	Copper Manifold Drain with bottom exit	No Charge
HWBI-CORD-S2	Cord for HWBI-S2 (single phase)	\$112
HWBI-CORD-S3, -S4	Cord for HWBI-S3, -S4 (single phase/single Control Box only)	112
OS-BEZEL19	19" D Bezel for Modular unit to match Hatco CWB Slim models in a countertop display	No Charge
<b>NEW</b> Gasket Options –		
BEZELGASKET-S2	Factory installed for HWBI-S2	\$ 121
BEZELGASKET-S3	Factory installed for HWBI-S3	158
BEZELGASKET-S4	Factory installed for HWBI-S4	158

#### COUNTERTOP CUT-OUT DIMENSIONS – PAGE 45 ACCESSORIES – PAGES 47, 58-59

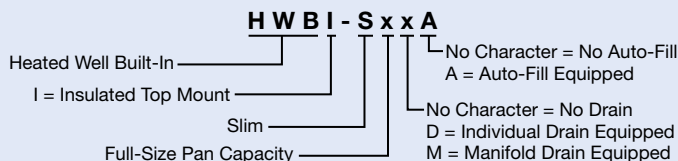

#### DROP-IN SLIM MODULAR/GANGED 3 Ø AMP RATINGS

Model	208V/3 Ø Amps	240V/3 Ø Amps
HWBI-S2	10.1	8.7
HWBI-S3	10.1	8.8
HWBI-S4	15.8	13.7

**NOTE:** Split Control Configurations are not available in Canada.

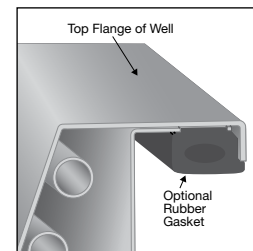

**BEZELGASKET-S2**  
Factory installed option (eliminates the need for silicone or other sealants)

## Modular/Ganged Heated Wells Accessories

(available for purchase at any time)



### HEATED WELL COVERS (available for purchase at any time)

For Modular/Ganged Heated Wells and Modular/Ganged Slim Heated Wells. (Choose the number of heated well covers for your appropriate pan size in either 1 or 2-Pan sizes, not available for HWBI43 series) –

**1-Pan Heated Well Cover** (Overall: 14" W x 22" D x 2" H) –

<b>1COVFUL-GGRAN</b>	1 Heated Well Cover in Gray Granite	<b>\$654</b>
<b>1COVFUL-BSAND</b>	1 Heated Well Cover in Bermuda Sand	<b>654</b>
<b>1COVFUL-NSKY</b>	1 Heated Well Cover in Night Sky	<b>654</b>

**2-Pan Heated Well Cover** (Overall: 28" W x 22" D x 2" H) –

<b>2COVFUL-GGRAN</b>	2 Heated Well Cover in Gray Granite	<b>\$1103</b>
<b>2COVFUL-BSAND</b>	2 Heated Well Cover in Bermuda Sand	<b>1103</b>
<b>2COVFUL-NSKY</b>	2 Heated Well Cover in Night Sky	<b>1103</b>

**ADDITIONAL ACCESSORIES – PAGES 58-59**  
**COLORS AND FINISHES – INSIDE BACK COVER**

**HWBI-3**  
(3-pan size) with accessory heated well covers (one 1-pan heated well cover and one 2-pan heated well cover)



**1COVFUL-GGRAN**  
accessory

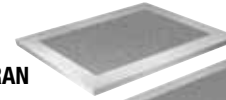

**2COVFUL-GGRAN**  
accessory

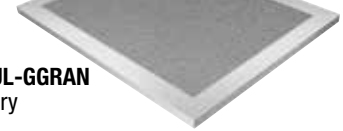

#### HEATED WELL COVER COMBINATIONS PER HWBI SERIES

Model Series	Using only:		Model Series	Using both:	
	1COVFUL	2COVFUL		1COVFUL	2COVFUL
HWBI-1	1	–	HWBI-1	1	–
HWBI-2.-S2	2	–	HWBI-2	–	1
HWBI-3.-S3	3	–	HWBI-3	1	1
HWBI-4.-S4	4	–	HWBI-4	–	2
HWBI-5	5	–	HWBI-5	1	2
HWBI-6	6	–	HWBI-6	–	3



**HWB-2-11Q**

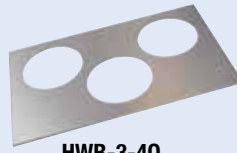

**HWB-3-4Q**

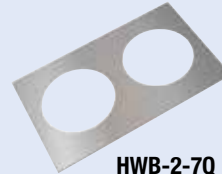

**HWB-2-7Q**

**HWB-2-7Q**  
shown with two 7QT-PAN and 7QT-LID-1



### ADAPTERS – SUPPORT BARS

<b>HWB-2-7Q</b>	Adapter to convert warmer to hold two 7-Quart Inserts (HWBI and HWBI-S Modular Heated Wells only)	<b>\$ 107</b>
<b>HWB-3-4Q</b>	Adapter to convert warmer to hold three 4-Quart Inserts (HWBI and HWBI-S Modular Heated Wells only)	<b>107</b>
<b>HWB-2-11Q</b>	Adapter to convert warmer to hold two 11-Quart Inserts (HWBI43 Modular Heated Wells only)	<b>134</b>
<b>HWBGM12BAR</b>	12" Pan Support Bar for Drop-In Modular/Ganged Models	<b>23</b>
<b>HWBGM20BAR</b>	20" Pan Support Bar for Drop-In Modular/Ganged Models (not available for HWBI43 series)	<b>27</b>



**Support Bars**  
Choose the appropriate kit for HWBI or HWB series

### MOUNTING KITS – VALVES

**Necessary at your Well Installation –**

<b>HWB-MNT-REC</b>	Kit allows mounting to thick, non-combustible countertops - 8 Brackets	<b>\$98</b>
--------------------	--	-------------

**External Manifold includes Individual Ball Valve for each Well (HWBI only, not available for the Slim models) –**

<b>HWBI2MANIF</b>	2-Pan Accessory	<b>\$ 1014</b>
<b>HWBI3MANIF</b>	3-Pan Accessory	<b>1439</b>
<b>HWBI4MANIF</b>	4-Pan Accessory	<b>1864</b>
<b>HWBI5MANIF</b>	5-Pan Accessory	<b>2289</b>
<b>HWBI6MANIF</b>	6-Pan Accessory	<b>2714</b>

**Necessary at your Well Installation –**

<b>BALLVALVE3/4</b>	High Temperature 3/4" NPT Ball Valve for units with Individual Drain(s) and no Manifold	<b>\$128</b>
<b>BALLVALVE1INCH</b>	High Temperature 1" NPT Ball Valve for units with Manifold Drain	<b>98</b>
<b>GATEVALVE3/4IN</b>	High Temperature 3/4" NPT Gate Valve for units with Individual Drain(s) and no Manifold	<b>147</b>
<b>GATEVALVE1INCH</b>	High Temperature 1" NPT Gate Valve for units with Manifold Drain	<b>218</b>
<b>HWB-RDHV</b>	Heated Well Remote Handle for 3/4" Drains only and includes a Ball Valve	<b>505</b>



**HWB-MNT-REC**



**HWBI2MANIF**



**BALLVALVE1INCH**



**GATEVALVE1INCH**



**HWB-RDHV**  
Attaches to 3/4" Drain and includes a Ball Valve

## Individual Built-In Heated Wells Ordering Instructions

Please specify the following with each order:

1. **Desired Voltage:** 120, 208 or 240V
2. **Base Size of Heated Well:**
  - A. Rectangular:  
Full (12" x 20") or 4/3 (12" x 27")
  - B. Round:  
4-quart, 7-quart or 11-quart
3. **Drain** (with or without)
4. **Auto-fill** (with or without)
5. **Insulated or Uninsulated**



**Insulated Well Construction**  
Full-size models are available with insulation for energy savings

6. **Mounting Style:**
  - A. Top Mounted
  - B. Bottom Mounted (rectangular full-size units only)
7. **Wattage:**
  - A. High watt
  - B. Standard watt
  - C. Low watt (120V only)

**NOTE:** Round Heated Wells are only available in standard and high watt configurations (4-quart available in standard watt only)
8. **Agency:**
  - A. UL and C-UL
  - B. UR (UL Recognized – Conduit and Control Enclosure not included [fabricators will need to obtain UL approvals])
  - C. C-UR (C-UL Recognized – Conduit and Control Enclosure not included [fabricators will need to obtain UL approvals])
  - D. UL-EPH (sanitary listing)

### CONTROL BOXES, COUNTERTOP CUT-OUT DIMENSIONS – PAGE 49

**HWBIB-FULD**  
with accessory food pan

Thicker gauge steel construction means Hatco Heated Wells will last longer under the rigorous wear and tear of the foodservice industry

**HWBI-FULD**  
with accessory food pan

Insulated well cavities ensure energy efficiency



**HWB-FULD** with accessory food pan (single unit holding 3 third-size pans unit depth is 21¾")

**HWB-43D** with accessory food pans (single unit holding 4 third-size pans – unit depth is 28⅝")



Easy to access the heating elements, if it ever becomes necessary to change them



Top Mounted Heated Well: Unit is mounted through the top surface of a sheet metal counter and secured with turn tabs (unit and food pan edge visible)



Bottom Mounted Heated Well: Full-size (only) unit is mounted to the bottom surface of a sheet metal counter and secured with customer provided turned bends and fasteners (only food pan edge visible)

**HWBI-11QTDA**  
with accessory food pan



**HWB-11QT**  
with accessory food pan



**HWBI-7QTDA**  
with accessory food pan

**HWB-7QT**  
with accessory food pan

**HWB-4QT**  
with accessory food pan

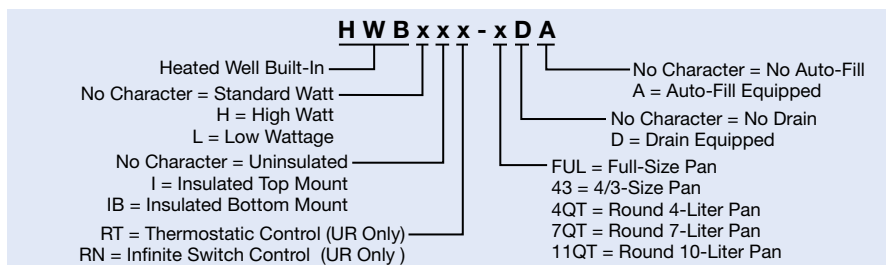



# Individual Built-In Heated Wells Ordering Instructions

## Options for Individual Built-In Heated Wells

- Control Box:**
  - Standard (compact) Thermostatic Control Box with Lighted On/Off Rocker Switch and Decorative Bezel. Can be front mounted or back mounted, and used with or without the Decorative Bezel (not available for auto-fill)
  - Optional Larger (front mounted) Recessed Thermostatic Control Box with Lighted On/Off Rocker Switch and Angled Recessed Controls for easy readability (not available for auto-fill)
  - Optional WM Control Assembly available that will replace most existing controls (not for auto-fill or Insulated Round Wells)
  - Optional ITC Control (not available for auto-fill, 4-quart Round Wells, Insulated Round Wells or low watt configurations)
  - Standard Control for auto-fill models only
- Control Type:**
  - Thermostatic
  - Infinite

**NOTE:** Infinite controls are only available on UR units
- Leads** – Extended high temp lead wire, per foot (1 foot standard)
- Thermostat** with 6' Capillary (3' standard)
- Corners**
  - Standard (Rounded)
  - Square Corners

## CONTROLS FOR UL and C-UL MODELS

### STANDARD CONTROLS

Standard Thermostatic Control with bezel



### STANDARD CONTROL AUTO-FILL

Standard Control (only for auto-fill)



## OPTIONAL CONTROLS



WM Control Assembly (not for auto-fill or Insulated Round Wells)



ITC Control (Not available for 4-quart Round Wells, low watt configurations, auto-fill or Insulated Rounds Wells)



Larger Recessed Thermostatic Control

## CONTROL CUTOUT DIMENSIONS

Control Box	Width	Height
Standard Thermostatic (with bezel)	3 1/4"	3 3/4"
Optional WM Control Assembly	4 3/4"	5"
Optional Larger Recessed Thermostatic	5 7/8"	6 3/8"
Optional ITC	5 7/8"	6 3/8"
Standard Control for Auto-fill	10 1/8"	4 3/4"

## FABRICATOR CONTROLS ONLY – UR and C-UR Components

"RT" added to model number indicates unit with thermostatic control, lit rocker switch and 36" capillary



"RN" added to model number indicates unit with infinite switch control, pilot light and 36" leads



## CONTROL CUTOUT DIMENSIONS

Control	Width	Height
Thermostatic	2 1/8"	3 3/8"
Infinite	2 1/8"	3 3/8"

## Accessories for Individual Built-In Heated Wells

- Mounting Kits** for combustible countertops (individual drop-in top mount units only)
- Pan Support Bars:** 12" or 20"
- Adapters** to convert rectangular full-size units to hold 4- or 7-quart round pans, or 4/3-size units to hold 11-quart round pans
- Stainless Steel Pans:**
  - Third-size at 2 1/2" deep (12 3/4"W x 6 7/8"D x 2 1/2"H)
  - Half-size at 2 1/2" deep (12 3/4"W x 10 3/8"D x 2 1/2"H)
  - Full-size at 2 1/2" deep (12 3/4"W x 20 3/4"D x 2 1/2"H)
  - Full-size at 4" deep (12 3/4"W x 20 3/4"D x 4"H)
  - Full-size at 6" deep (12 3/4"W x 20 3/4"D x 6"H)
- Valve**
  - 3/4" NPT Ball Valve for unit with Drain
  - 3/4" NPT Gate Valve for unit with Drain
- Remote Handle** for 3/4" Drains only and includes a Ball Valve

## ACCESSORIES – PAGES 58-59

**How to Order a Hatco® Heated Well in Video**  
Hatco has given you a variety of simple and easy ways to order your well. You can read the Ordering Instructions here or watch a video "How to Order a Hatco® Heated Well." Go to [hatcocorp.com](http://hatcocorp.com) and click on the Video Library. While you are there, watch the "Hatco® Refrigerated Wells" video as well.

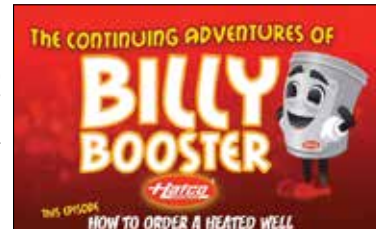

## COMBUSTIBLE COUNTERTOP CUTOUTS – BUILT-IN AND DROP-IN HEATED WELLS

Model	Minimum Width	Maximum Width	Minimum Depth	Maximum Depth
HWB-FUL, -FULD, FULDA	14"	14 1/4"	22"	22 1/4"
HWBI-FUL, -FULD, FULDA	14"	14 1/4"	22"	22 1/4"
HWB-, HWBI-43	14"	14 1/4"	29"	29 1/4"
HWB-, HWBI-4QT	9"	9 1/4"	9"	9 1/4"
HWB-, HWBI-7QT	11"	11 1/4"	11"	11 1/4"
HWB-, HWBI-11QT	13"	13 1/4"	13"	13 1/4"

## NON-COMBUSTIBLE COUNTERTOP CUTOUTS – BUILT-IN AND DROP-IN HEATED WELLS

Model	Minimum Width	Maximum Width	Minimum Depth	Maximum Depth
HWB-FUL, -FULD	12 5/8"	12 5/16"	20 5/8"	20 5/16"
HWB-FULDA	12 5/8"	12 5/16"	20 5/8"	20 5/16"
HWBI-FUL, -FULD	12 3/4"	12 5/16"	20 3/4"	20 5/16"
HWBI-FULDA®	12 3/4"	12 5/16"	20 7/8"	20 5/16"
HWBIB-FUL®, -FULDA®	12 1/32"	12 1/32"	20 1/32"	20 1/32"
HWB-, HWBI-43	12 1/16"	12 5/16"	27 1/16"	28"
HWB-4QT,	7 7/8" Dia.	7 7/16" Dia.	—	—
HWB-7QT	9 7/8" Dia.	9 7/16" Dia.	—	—
HWB-11QT	11 7/8" Dia.	11 7/16" Dia.	—	—
HWBI-4QT,	7 3/8" Dia.	7 3/8" Dia.	—	—
HWBI-7QT	9 1/16" Dia.	9 1/16" Dia.	—	—
HWBI-11QT	11 3/8" Dia.	11 3/8" Dia.	—	—

® Must be flanged.



## Built-In Full-Size Heated Wells - UL and C-UL Models

Hatco Built-In Heated Wells hold heated foods at safe-serving temperatures. Compared to other models, Hatco units offer a larger drain with a flat drain screen, more consistent holding temperatures, heavier stainless steel construction, easier-to-service design for quick change of components and a remote thermostat with separate power switch.

- Rectangular full-size only in top or bottom mount, insulated or uninsulated
- Low (120V only), standard and high watt
- Available with or without a drain (easy to clean with a larger drain and a flat screen)
- Easy access design allows for quick element or thermostat change
- Available with optional square corners in lieu of standard round corners
- Accessory mounting kits for combustible countertops available
- Accessory adapters to convert full-size wells to hold round pans

## Control Options

- See page 49



**HWB-FULD**  
with  
accessory  
food pan



**HWBI-FULD**  
with accessory  
food pan

**HWBIB-FULD**  
with accessory  
food pan

### BUILT-IN FULL-SIZE RECTANGULAR UL AND C-UL WELLS

Model	Description	Dimensions W x D x H	Voltage	Watts	Approx. Ship Weight	List Price
<b>Low Watt</b>						
<b>HWBL-FUL</b>	Uninsulated Top or Bottom Mount	13 <sup>1</sup> / <sub>16</sub> " x 21 <sup>3</sup> / <sub>4</sub> " x 9 <sup>9</sup> / <sub>16</sub> "	120	750	22 lbs.	<b>\$ 945</b>
<b>HWBL-FULD</b>	Uninsulated Top or Bottom Mount w/Drain	13 <sup>1</sup> / <sub>16</sub> " x 21 <sup>3</sup> / <sub>4</sub> " x 9 <sup>9</sup> / <sub>16</sub> "	120	750	22 lbs.	<b>998</b>
<b>HWBL-FULDA</b>	Uninsulated Top or Bottom Mount w/Drain, Auto-fill	13 <sup>1</sup> / <sub>16</sub> " x 21 <sup>3</sup> / <sub>4</sub> " x 9 <sup>7</sup> / <sub>16</sub> "	120	765	21 lbs.	<b>1813</b>
<b>HWBLI-FUL</b>	Insulated Top or Bottom Mount	13 <sup>1</sup> / <sub>16</sub> " x 21 <sup>3</sup> / <sub>4</sub> " x 10 <sup>5</sup> / <sub>16</sub> "	120	750	30 lbs.	<b>1075</b>
<b>HWBLI-FULD</b>	Insulated Top or Bottom Mount w/Drain	13 <sup>1</sup> / <sub>16</sub> " x 21 <sup>3</sup> / <sub>4</sub> " x 10 <sup>5</sup> / <sub>16</sub> "	120	750	26 lbs.	<b>1128</b>
<b>HWBLI-FULDA</b>	Insulated Top Mount Only w/Drain, Auto-fill	13 <sup>1</sup> / <sub>16</sub> " x 21 <sup>3</sup> / <sub>4</sub> " x 10 <sup>3</sup> / <sub>8</sub> "	120	765	30 lbs.	<b>1943</b>
<b>HWBLIB-FUL</b>	Insulated Bottom Mount Only	13 <sup>7</sup> / <sub>8</sub> " x 22 <sup>1</sup> / <sub>8</sub> " x 10 <sup>5</sup> / <sub>16</sub> "	120	750	30 lbs.	<b>1075</b>
<b>HWBLIB-FULD</b>	Insulated Bottom Mount Only w/Drain	13 <sup>7</sup> / <sub>8</sub> " x 22 <sup>1</sup> / <sub>8</sub> " x 10 <sup>5</sup> / <sub>16</sub> "	120	750	29 lbs.	<b>1128</b>
<b>HWBLIB-FULDA</b>	Insulated Bottom Mount Only w/Drain, Auto-fill	13 <sup>7</sup> / <sub>8</sub> " x 22 <sup>1</sup> / <sub>8</sub> " x 10 <sup>5</sup> / <sub>16</sub> "	120	765	35 lbs.	<b>1943</b>
<b>Standard Watt</b>						
<b>HWB-FUL</b>	Uninsulated Top or Bottom Mount	13 <sup>1</sup> / <sub>16</sub> " x 21 <sup>3</sup> / <sub>4</sub> " x 9 <sup>9</sup> / <sub>16</sub> "	120, 208 or 240	1200	22 lbs.	<b>\$ 945</b>
<b>HWB-FULD</b>	Uninsulated Top or Bottom Mount w/Drain	13 <sup>1</sup> / <sub>16</sub> " x 21 <sup>3</sup> / <sub>4</sub> " x 9 <sup>9</sup> / <sub>16</sub> "	120, 208 or 240	1200	22 lbs.	<b>998</b>
<b>HWB-FULDA</b>	Uninsulated Top or Bottom Mount w/Drain, Auto-fill	13 <sup>1</sup> / <sub>16</sub> " x 21 <sup>3</sup> / <sub>4</sub> " x 9 <sup>7</sup> / <sub>16</sub> "	120, 208 or 240	1215	31 lbs.	<b>1813</b>
<b>HWBI-FUL</b>	Insulated Top or Bottom Mount	13 <sup>1</sup> / <sub>16</sub> " x 21 <sup>3</sup> / <sub>4</sub> " x 10 <sup>5</sup> / <sub>16</sub> "	120, 208 or 240	1200	26 lbs.	<b>1075</b>
<b>HWBI-FULD</b>	Insulated Top or Bottom Mount w/Drain	13 <sup>1</sup> / <sub>16</sub> " x 21 <sup>3</sup> / <sub>4</sub> " x 10 <sup>5</sup> / <sub>16</sub> "	120, 208 or 240	1200	25 lbs.	<b>1128</b>
<b>HWBI-FULDA</b>	Insulated Top Mount Only w/Drain, Auto-fill	13 <sup>1</sup> / <sub>16</sub> " x 21 <sup>3</sup> / <sub>4</sub> " x 10 <sup>3</sup> / <sub>8</sub> "	120, 208 or 240	1215	30 lbs.	<b>1943</b>
<b>HWBIB-FUL</b>	Insulated Bottom Mount Only	13 <sup>7</sup> / <sub>8</sub> " x 22 <sup>1</sup> / <sub>8</sub> " x 10 <sup>5</sup> / <sub>16</sub> "	120, 208 or 240	1200	28 lbs.	<b>1075</b>
<b>HWBIB-FULD</b>	Insulated Bottom Mount Only w/Drain	13 <sup>7</sup> / <sub>8</sub> " x 22 <sup>1</sup> / <sub>8</sub> " x 10 <sup>5</sup> / <sub>16</sub> "	120, 208 or 240	1200	28 lbs.	<b>1128</b>
<b>HWBIB-FULDA</b>	Insulated Bottom Mount Only w/Drain, Auto-fill	13 <sup>7</sup> / <sub>8</sub> " x 22 <sup>1</sup> / <sub>8</sub> " x 10 <sup>5</sup> / <sub>16</sub> "	120, 208 or 240	1215	35 lbs.	<b>1943</b>
<b>High Watt</b>						
<b>HWBH-FUL</b>	Uninsulated Top or Bottom Mount	13 <sup>1</sup> / <sub>16</sub> " x 21 <sup>3</sup> / <sub>4</sub> " x 9 <sup>9</sup> / <sub>16</sub> "	120, 208 or 240	1650	22 lbs.	<b>\$ 945</b>
<b>HWBH-FULD</b>	Uninsulated Top or Bottom Mount w/Drain	13 <sup>1</sup> / <sub>16</sub> " x 21 <sup>3</sup> / <sub>4</sub> " x 9 <sup>9</sup> / <sub>16</sub> "	120, 208 or 240	1650	22 lbs.	<b>998</b>
<b>HWBH-FULDA</b>	Uninsulated Top or Bottom Mount w/Drain, Auto-fill	13 <sup>1</sup> / <sub>16</sub> " x 21 <sup>3</sup> / <sub>4</sub> " x 9 <sup>7</sup> / <sub>16</sub> "	120, 208 or 240	1665	26 lbs.	<b>1813</b>
<b>HWBHI-FUL</b>	Insulated Top or Bottom Mount	13 <sup>1</sup> / <sub>16</sub> " x 21 <sup>3</sup> / <sub>4</sub> " x 10 <sup>5</sup> / <sub>16</sub> "	120, 208 or 240	1650	26 lbs.	<b>1075</b>
<b>HWBHI-FULD</b>	Insulated Top or Bottom Mount w/Drain	13 <sup>1</sup> / <sub>16</sub> " x 21 <sup>3</sup> / <sub>4</sub> " x 10 <sup>5</sup> / <sub>16</sub> "	120, 208 or 240	1650	31 lbs.	<b>1128</b>
<b>HWBHI-FULDA</b>	Insulated Top Mount Only w/Drain, Auto-fill	13 <sup>1</sup> / <sub>16</sub> " x 21 <sup>3</sup> / <sub>4</sub> " x 10 <sup>3</sup> / <sub>8</sub> "	120, 208 or 240	1665	30 lbs.	<b>1943</b>
<b>HWBHIB-FUL</b>	Insulated Bottom Mount Only	13 <sup>7</sup> / <sub>8</sub> " x 22 <sup>1</sup> / <sub>8</sub> " x 10 <sup>5</sup> / <sub>16</sub> "	120, 208 or 240	1650	30 lbs.	<b>1075</b>
<b>HWBHIB-FULD</b>	Insulated Bottom Mount Only w/Drain	13 <sup>7</sup> / <sub>8</sub> " x 22 <sup>1</sup> / <sub>8</sub> " x 10 <sup>5</sup> / <sub>16</sub> "	120, 208 or 240	1650	30 lbs.	<b>1128</b>
<b>HWBHIB-FULDA</b>	Insulated Bottom Mount Only w/Drain, Auto-fill	13 <sup>7</sup> / <sub>8</sub> " x 22 <sup>1</sup> / <sub>8</sub> " x 10 <sup>5</sup> / <sub>16</sub> "	120, 208 or 240	1665	35 lbs.	<b>1943</b>

#### All Built-In Full-Size Rectangular Heated Well Models Feature:

**Voltage:** Single phase.

**Models Shipped with:** EZ locking hardware for installation (top mounted only), 3' conduits between the control and well (except auto-fill unit) and a remote thermostat with lighted power switch.

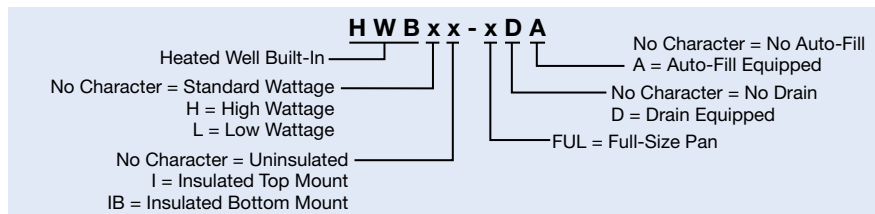

**COUNTERTOP CUT-OUT  
DIMENSIONS – PAGE 49  
OPTIONS – PAGE 51  
ACCESSORIES – PAGES 58-59**



**HWBL-43D and HWBLI-FULD** with accessory food pans (shown with **GR2AHL** with standard *Designer* non-adjustable stands and optional *Designer* Black and sneeze guards)



**Standard Thermostatic Control** with control box bezel in optional *Designer* Warm Red



**HWB-ITC** – Optional control (not available for auto-fill, units without a drain, or low watt configurations) shown in optional control box bezel in *Designer* White Granite

**OPTIONS** (available at time of purchase only)

**Designer Colors for Flush Mount Control Box Bezel, not available for Auto-fill or HWB-FUL w/cord – Non-standard colors are non-returnable – Stainless Steel is standard –**

<b>RED</b>	Warm Red	<b>\$47</b>
<b>BLACK</b>	Black	<b>47</b>
<b>GRAY</b>	Gray Granite	<b>47</b>
<b>WHITE</b>	White Granite	<b>47</b>
<b>NAVY</b>	Navy Blue	<b>47</b>
<b>GREEN</b>	Hunter Green	<b>47</b>
<b>COPPER</b>	Antique Copper	<b>47</b>
<b>HWB-LEAD</b>	Power Supply Lead Wire (Lead Wire only – Conduit not included)	<b>per foot \$14</b>
<b>HWB-CORD</b>	HWB-FUL with Cord Standard (Shown below) (Not available for auto-fill models, low watt models available in 120V only)	<b>add 43</b>
<b>HWBI-CORD</b>	HWBI-FUL with Cord Standard (Shown below) All models except Insulated Top Mount with auto-fill, low watt models are available in 120V only)	<b>add \$43</b>
<b>HWBIB-BRKT</b>	Mounting Bracket for Insulated Bottom Mount (HWBIB series)	<b>add 28</b>
<b>HWB-SQUARE</b>	Square Pan Corners (In lieu of standard round pan corners)	<b>add 106</b>
<b>Control Options –</b>		
<b>HWB-TSTAT</b>	Thermostat with 6' Capillary, (in lieu of standard 3', not available for auto-fill)	<b>\$96</b>
<b>HWB-RTC</b>	Larger Recessed Thermostatic Control Box (not available for auto-fill)	<b>No Charge</b>
<b>HWB-ITC</b>	ITC Control with Large Control Box (not available for auto-fill, units without a drain or low watt configurations)	<b>\$320</b>
<b>WM Assembly</b>	Control Assembly Replacement (not available for auto-fill models)	<b>No Charge</b>

**ACCESSORIES – PAGE 58-59**  
**COLORS AND FINISHES – INSIDE BACK COVER**

**HWB-FUL with optional HWB-CORD**



**HWBIB-FULD with optional HWBI-CORD and accessory food pan**



**Square Corner**



**Standard Corner**



**HWB-FUL with optional HWB-TSTAT Thermostat with 6' capillary (Not available for auto-fill)**

Wells





### Drop-In 4/3-Size Heated Wells - UL and C-UL Models

Convenient 4/3-Size Wells hold heated foods at safe-serving temperatures. Like the full-size models, Hatco units offer a larger drain with a flat drain screen, more consistent holding temperatures, heavier stainless steel construction, easier-to-service design for quick change of components and a remote thermostat with separate power switch.

- Rectangular 4/3-size wells
- Low (120V only), standard and high watt
- Available with or without a drain (easy to clean with larger drain and flat screen)
- Easy access design allows for quick element or thermostat change
- Accessory mounting kits for combustible countertops available
- Accessory adapters to convert 4/3-size wells to hold round pans available

### Control Options

- See page 49

**HWB-43D** with accessory food pans (single unit holding 4 third-size pans)



**HWBI-43D** with accessory food pans (single unit holding 4 third-size pans)



### DROP-IN 4/3-SIZE RECTANGULAR UL AND C-UL WELLS

Model	Description	Dimensions W x D x H	Voltage	Watts	Approx. Ship Weight	List Price
<b>Low Watt</b>						
<b>HWBL-43</b>	Uninsulated	13 <sup>5</sup> / <sub>8</sub> " x 28 <sup>5</sup> / <sub>8</sub> " x 9 <sup>7</sup> / <sub>16</sub> "	120	750	35 lbs.	<b>\$1053</b>
<b>HWBL-43D</b>	Uninsulated w/Drain	13 <sup>5</sup> / <sub>8</sub> " x 28 <sup>5</sup> / <sub>8</sub> " x 9 <sup>7</sup> / <sub>16</sub> "	120	750	24 lbs.	<b>1106</b>
<b>HWBL-43DA</b>	Uninsulated w/Drain, Auto-fill	13 <sup>5</sup> / <sub>8</sub> " x 28 <sup>5</sup> / <sub>8</sub> " x 9 <sup>7</sup> / <sub>16</sub> "	120	765	36 lbs.	<b>1921</b>
<b>HWBLI-43</b>	Insulated	13 <sup>5</sup> / <sub>8</sub> " x 28 <sup>5</sup> / <sub>8</sub> " x 10 <sup>5</sup> / <sub>16</sub> "	120	750	33 lbs.	<b>1183</b>
<b>HWBLI-43D</b>	Insulated w/Drain	13 <sup>5</sup> / <sub>8</sub> " x 28 <sup>5</sup> / <sub>8</sub> " x 10 <sup>5</sup> / <sub>16</sub> "	120	750	31 lbs.	<b>1236</b>
<b>Standard Watt</b>						
<b>HWB-43</b>	Uninsulated	13 <sup>5</sup> / <sub>8</sub> " x 28 <sup>5</sup> / <sub>8</sub> " x 9 <sup>7</sup> / <sub>16</sub> "	120, 208 or 240	1200	24 lbs.	<b>\$1053</b>
<b>HWB-43D</b>	Uninsulated w/Drain	13 <sup>5</sup> / <sub>8</sub> " x 28 <sup>5</sup> / <sub>8</sub> " x 9 <sup>7</sup> / <sub>16</sub> "	120, 208 or 240	1200	24 lbs.	<b>1106</b>
<b>HWB-43DA</b>	Uninsulated w/Drain, Auto-fill	13 <sup>5</sup> / <sub>8</sub> " x 28 <sup>5</sup> / <sub>8</sub> " x 9 <sup>7</sup> / <sub>16</sub> "	120, 208 or 240	1215	27 lbs.	<b>1921</b>
<b>HWBI-43</b>	Insulated	13 <sup>5</sup> / <sub>8</sub> " x 28 <sup>5</sup> / <sub>8</sub> " x 10 <sup>5</sup> / <sub>16</sub> "	120, 208 or 240	1200	30 lbs.	<b>1183</b>
<b>HWBI-43D</b>	Insulated w/Drain	13 <sup>5</sup> / <sub>8</sub> " x 28 <sup>5</sup> / <sub>8</sub> " x 10 <sup>5</sup> / <sub>16</sub> "	120, 208 or 240	1200	31 lbs.	<b>1236</b>
<b>High Watt</b>						
<b>HWBH-43</b>	Uninsulated	13 <sup>5</sup> / <sub>8</sub> " x 28 <sup>5</sup> / <sub>8</sub> " x 9 <sup>7</sup> / <sub>16</sub> "	120, 208 or 240	1650	24 lbs.	<b>\$1053</b>
<b>HWBH-43D</b>	Uninsulated w/Drain	13 <sup>5</sup> / <sub>8</sub> " x 28 <sup>5</sup> / <sub>8</sub> " x 9 <sup>7</sup> / <sub>16</sub> "	120, 208 or 240	1650	24 lbs.	<b>1106</b>
<b>HWBH-43DA</b>	Uninsulated w/Drain, Auto-fill	13 <sup>5</sup> / <sub>8</sub> " x 28 <sup>5</sup> / <sub>8</sub> " x 9 <sup>7</sup> / <sub>16</sub> "	120, 208 or 240	1665	30 lbs.	<b>1921</b>
<b>HWBHI-43</b>	Insulated	13 <sup>5</sup> / <sub>8</sub> " x 28 <sup>5</sup> / <sub>8</sub> " x 10 <sup>5</sup> / <sub>16</sub> "	120, 208 or 240	1650	30 lbs.	<b>1183</b>
<b>HWBHI-43D</b>	Insulated w/Drain	13 <sup>5</sup> / <sub>8</sub> " x 28 <sup>5</sup> / <sub>8</sub> " x 10 <sup>5</sup> / <sub>16</sub> "	120, 208 or 240	1650	30 lbs.	<b>1236</b>

#### All Drop-In 4/3-Size Rectangular Heated Well Models Feature:

Voltage: Single phase.

Models Shipped with: EZ locking hardware for installation, 3' conduits between the control and well (except auto-fill unit) and a remote thermostat with lighted power switch.

### OPTIONS (available at time of purchase only)

<b>HWB-LEAD</b>	Power Supply Lead Wire (Lead Wire only - Conduit not included)	per foot <b>\$14</b>
<b>HWB-AFL</b>	Models HWB, HWBH, HWBL-43DA only - Left water fill hole (front is standard)	<b>No Charge</b>
<b>HWB-AFR</b>	Models HWB, HWBH, HWBL-43DA only - Right water fill hole (front is standard)	<b>No Charge</b>
<b>Control Options -</b>		
<b>HWB-TSTAT</b>	Thermostat with 6" Capillary (in lieu of standard 3', not available for auto-fill)	<b>\$96</b>
<b>HWB-RTC</b>	Larger Recessed Thermostatic Control Box (not available for auto-fill)	<b>No Charge</b>
<b>WM Assembly</b>		
	Control Assembly Replacement (not available for auto-fill models)	<b>No Charge</b>
<b>HWB-ITC</b>	ITC Control with Large Control Box (not available for auto-fill, units without a drain or low watt configurations)	<b>\$320</b>

#### Designer Colors (Control Box Bezel) -

Not available for Auto-fill -

Non-standard colors are non-returnable -

Stainless Steel is standard -

<b>RED</b>	Warm Red	<b>\$47</b>
<b>BLACK</b>	Black	<b>47</b>
<b>GRAY</b>	Gray Granite	<b>47</b>
<b>WHITE</b>	White Granite	<b>47</b>
<b>NAVY</b>	Navy Blue	<b>47</b>
<b>GREEN</b>	Hunter Green	<b>47</b>
<b>COPPER</b>	Antique Copper	<b>47</b>

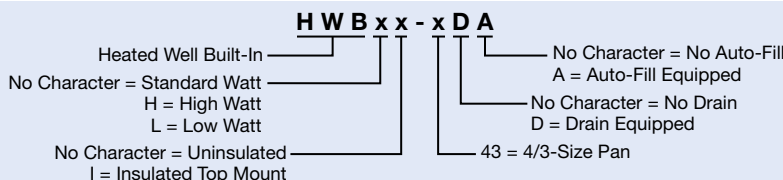

COUNTERTOP CUT-OUT DIMENSIONS - PAGE 49  
ACCESSORIES - PAGES 58-59  
COLORS AND FINISHES - INSIDE BACK COVER



## Drop-In Round Uninsulated Heated Wells - UL And C-UL Models

Keeping hot food at safe-serving temperatures is critical to any foodservice operation – and Hatco has the Heated Wells to meet the demands of any serving application. Thermostatic controls monitor and regulate the temperature of the well for more accurate heat and energy savings. Hatco controls feature a separate On/Off switch, which allows a previously determined setting to be maintained.

- 4-, 7- and 11-quart Round Wells
- Standard or high watt (4-quart standard watt only)
- With or without drain
- EZ locking hardware for easy top mount installation
- Accessory mounting kits for combustible countertops available



## Control Options

- Standard (compact) thermostatic control box with lighted On/Off rocker switch and decorative bezel. Can be front mounted or back mounted, and used with or without the decorative bezel
- Optional larger (front mounted) recessed thermostatic control box with lighted On/Off rocker switch and angled recessed controls for easy readability
- Optional WM control assembly available to replace most existing controls on a customer's Drop-In Heated Well unit for easier reading
- Optional ITC control with large control box available for easier reading on 7- or 11-quart standard or high watt configurations

### DROP-IN ROUND UL AND C-UL WELLS – UNINSULATED

Model	Description	Dimensions Dia. x H	Watts			Approx. Ship Weight	List Price
			120V	208V	240V		
<b>4-Quart – Standard Watt</b>							
HWB-4QT	Top Mount	8 <sup>3</sup> / <sub>16</sub> " x 10 <sup>5</sup> / <sub>16</sub> "	500	536	600	11 lbs.	\$899
HWB-4QTD	Top Mount w/Drain	8 <sup>3</sup> / <sub>16</sub> " x 10 <sup>5</sup> / <sub>16</sub> "	500	536	600	10 lbs.	952
<b>7-Quart – Standard Watt</b>							
HWB-7QT	Top Mount	10 <sup>5</sup> / <sub>16</sub> " x 9 <sup>9</sup> / <sub>16</sub> "	500	536	600	12 lbs.	\$899
HWB-7QTD	Top Mount w/Drain	10 <sup>5</sup> / <sub>16</sub> " x 9 <sup>9</sup> / <sub>16</sub> "	500	536	600	12 lbs.	952
<b>7-Quart – High Watt</b>							
HWBH-7QT	Top Mount	10 <sup>5</sup> / <sub>16</sub> " x 9 <sup>9</sup> / <sub>16</sub> "	800	715	800	12 lbs.	\$899
HWBH-7QTD	Top Mount w/Drain	10 <sup>5</sup> / <sub>16</sub> " x 9 <sup>9</sup> / <sub>16</sub> "	800	715	800	12 lbs.	952
<b>11-Quart – Standard Watt</b>							
HWB-11QT	Top Mount	12 <sup>5</sup> / <sub>16</sub> " x 9 <sup>9</sup> / <sub>16</sub> "	500	536	600	13 lbs.	\$899
HWB-11QTD	Top Mount w/Drain	12 <sup>5</sup> / <sub>16</sub> " x 9 <sup>9</sup> / <sub>16</sub> "	500	536	600	14 lbs.	952
<b>11-Quart – High Watt</b>							
HWBH-11QT	Top Mount	12 <sup>5</sup> / <sub>16</sub> " x 9 <sup>9</sup> / <sub>16</sub> "	800	715	800	13 lbs.	\$899
HWBH-11QTD	Top Mount w/Drain	12 <sup>5</sup> / <sub>16</sub> " x 9 <sup>9</sup> / <sub>16</sub> "	800	715	800	13 lbs.	952



Optional larger recessed thermostatic control



Standard thermostatic control with bezel



WM control assembly



Optional ITC control – (not for 4-quart Round Wells or units without drains) shown in optional control box bezel in Designer White Granite

#### All Drop-In Round Heated Well Models Feature:

Voltage: Single phase.

Models Shipped with: EZ locking hardware for installation, 3' conduits between the control and well and a remote thermostat with lighted power switch.

### OPTIONS (available at time of purchase only)

HWB-LEAD	Power Supply Lead Wire (Lead Wire only – Conduit not included)	per foot \$14
HWB-CORD	Optional cord available on models attached to control box in lieu of conduit and lead wire (120V only)	add 43
<b>Control Options –</b>		
HWB-TSTAT	Thermostat with 6' Capillary (in lieu of standard 3', not available for auto-fill)	\$96
HWB-RTC	Larger Recessed Thermostatic Control Box (not available for auto-fill)	No Charge
WM Assembly	Control Assembly Replacement	No Charge
HWB-ITC	ITC Control with large Control Box for 7- and 11-Quart Drop-In Round Wells only	\$320

#### Designer Colors (Control Box Bezel) – Non-standard colors are non-returnable –

#### Stainless Steel is standard –

RED	Warm Red	\$47
BLACK	Black	47
GRAY	Gray Granite	47
WHITE	White Granite	47
NAVY	Navy Blue	47
GREEN	Hunter Green	47
COPPER	Antique Copper	47

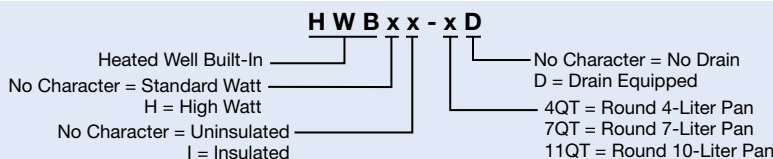

COUNTERTOP CUT-OUT DIMENSIONS – PAGE 49  
ACCESSORIES – PAGES 58-59  
COLORS AND FINISHES – INSIDE BACK COVER



### Drop-In Round Insulated Heated Wells – UL And C-UL Models

Hatco Drop-In Round Insulated Heated Wells provide flexibility and quality, with many options to choose from. These units hold steam table food hot and fresh with self-adjusting thermostats that monitor the actual temperatures and control the heat only when needed.

- Available in insulated 4-, 7- and 10-liter Round Wells
- Standard or high watt (4-liter standard watt only)
- Controls feature a separate lighted ON/OFF rocker switch and temperature dial, allowing preset temperatures to be maintained
- Easy service access to heating elements and thermostats
- Mounting kits for combustible countertops available
- Auto-Fill models available in 7 and 10 liter round wells

### Control Options

- Larger front-mounted recessed thermostatic control box with lighted On/Off rocker switch and angled recessed controls for easy readability



Larger recessed thermostatic control at no charge

HWBI-7QTDA with accessory food pan



HWBI-11QTDA with accessory food pan

### DROP-IN ROUND UL AND C-UL WELLS – INSULATED

Model	Description	Dimensions Dia. x H	Watts			Approx. Ship Weight	List Price
			120V	208V	240V		
<b>4-Liter (4-Quart) – Standard Watt</b>							
HWBI-4QT	Top Mount	8 3/8" x 10 1/16"	500	536	600	12 lbs.	<b>\$1029</b>
HWBI-4QTD	Top Mount w/Drain	8 3/8" x 10 1/16"	500	536	600	13 lbs.	<b>1082</b>
<b>7-Liter (7-Quart) – Standard Watt</b>							
HWBI-7QT	Top Mount	10 5/16" x 9 3/4"	500	536	600	12 lbs.	<b>\$1029</b>
HWBI-7QTD	Top Mount w/Drain	10 5/16" x 9 3/4"	500	536	600	15 lbs.	<b>1082</b>
HWBI-7QTDA	Top Mount w/Drain, Auto-fill	10 5/16" x 9 3/4"	515	551	615	15 lbs.	<b>1897</b>
<b>7-Liter (7-Quart) – High Watt</b>							
HWBHI-7QT	Top Mount	10 5/16" x 9 3/4"	800	715	800	13 lbs.	<b>\$1029</b>
HWBHI-7QTD	Top Mount w/Drain	10 5/16" x 9 3/4"	800	715	800	15 lbs.	<b>1082</b>
HWBHI-7QTDA	Top Mount w/Drain, Auto-fill	10 5/16" x 9 3/4"	815	730	815	19 lbs.	<b>1897</b>
<b>10-Liter (11-Quart) – Standard Watt</b>							
HWBI-11QT	Top Mount	12 5/16" x 9 3/4"	500	536	600	16 lbs.	<b>\$1029</b>
HWBI-11QTD	Top Mount w/Drain	12 5/16" x 9 3/4"	500	536	600	21 lbs.	<b>1082</b>
HWBI-11QTDA	Top Mount w/Drain, Auto-fill	12 5/16" x 9 3/4"	515	551	615	23 lbs.	<b>1897</b>
<b>10-Liter (11-Quart) – High Watt</b>							
HWBHI-11QT	Top Mount	12 5/16" x 9 3/4"	800	715	800	16 lbs.	<b>\$1029</b>
HWBHI-11QTD	Top Mount w/Drain	12 5/16" x 9 3/4"	800	715	800	16 lbs.	<b>1082</b>
HWBHI-11QTDA	Top Mount w/Drain, Auto-fill	12 5/16" x 9 3/4"	815	730	815	27 lbs.	<b>1897</b>

#### All Drop-In Round Insulated Heated Well Models Feature:

Voltage: Single phase.

Models Shipped with: EZ locking hardware for installation, 3' conduit and a remote thermostat with lighted power switch.

### OPTIONS (available at time of purchase only)

<b>HWB-LEAD</b>	Power Supply Lead Wire (Lead Wire only – Conduit not included)	<b>per foot \$14</b>
<b>HWBI-CORD</b>	Optional cord available on models attached to control box in lieu of conduit and lead wire (120V only)	<b>add 43</b>
<b>Control Options –</b>		
<b>HWB-TSTAT</b>	Thermostat with 6' Capillary (in lieu of standard 3', not available for auto-fill)	<b>\$96</b>
<b>HWB-RTC</b>	Larger Recessed Thermostatic Control (not available for auto-fill)	<b>No Charge</b>

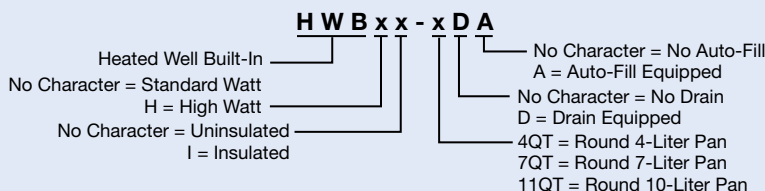

COUNTERTOP CUT-OUT DIMENSIONS – PAGE 49  
ACCESSORIES – PAGES 58-59

## Built-In Full-Size Heated Wells - UR and C-UR Components

Having the same great features as all of the Hatco Heated Wells, plus the added benefit of allowing fabricators the freedom to design their own steam tables, these units hold hot food products at safe-serving temperatures.

- Without conduit and control box enclosure
- Thermostatic or infinite controls available (infinite switch option not available on 120V high watt)
- With or without drains
- Low, standard and high watt models
- Available with optional square corners in lieu of standard round corners



**HWBRT-FULD** with accessory food pan

## Control Options

- See page 49

**HWBIBRT-FULD** with accessory food pan



**HWBIRT-FULD** with accessory food pan

**NOTE:** Fabricators will need to obtain UL approvals.

### BUILT-IN FULL-SIZE RECTANGULAR WELLS UR AND C-UR COMPONENTS

Model #	Description	Dimensions (W x D x H)	Voltage	Watts	Approx. Ship Weight	List Price
<b>Low Watt</b>						
<b>HWBLRT-FUL</b>	Uninsulated Top or Bottom Mount	13 <sup>11</sup> / <sub>16</sub> " x 21 <sup>3</sup> / <sub>4</sub> " x 9 <sup>3</sup> / <sub>8</sub> "	120	750	21 lbs.	<b>\$ 850</b>
<b>HWBLRT-FULD</b>	Uninsulated Top or Bottom Mount w/Drain	13 <sup>11</sup> / <sub>16</sub> " x 21 <sup>3</sup> / <sub>4</sub> " x 9 <sup>3</sup> / <sub>8</sub> "	120	750	20 lbs.	<b>903</b>
<b>HWBLRN-FUL</b>	Uninsulated Top or Bottom Mount	13 <sup>11</sup> / <sub>16</sub> " x 21 <sup>3</sup> / <sub>4</sub> " x 9 <sup>3</sup> / <sub>8</sub> "	120	750	19 lbs.	<b>850</b>
<b>HWBLRN-FULD</b>	Uninsulated Top or Bottom Mount w/Drain	13 <sup>11</sup> / <sub>16</sub> " x 21 <sup>3</sup> / <sub>4</sub> " x 9 <sup>3</sup> / <sub>8</sub> "	120	750	20 lbs.	<b>903</b>
<b>HWBLIRT-FUL</b>	Insulated Top or Bottom Mount	13 <sup>11</sup> / <sub>16</sub> " x 21 <sup>3</sup> / <sub>4</sub> " x 10 <sup>5</sup> / <sub>16</sub> "	120	750	27 lbs.	<b>980</b>
<b>HWBLIRT-FULD</b>	Insulated Top or Bottom Mount w/Drain	13 <sup>11</sup> / <sub>16</sub> " x 21 <sup>3</sup> / <sub>4</sub> " x 10 <sup>5</sup> / <sub>16</sub> "	120	750	19 lbs.	<b>1033</b>
<b>HWBLIBRT-FUL</b>	Insulated Bottom Mount Only	13 <sup>7</sup> / <sub>8</sub> " x 22 <sup>1</sup> / <sub>8</sub> " x 10 <sup>5</sup> / <sub>16</sub> "	120	750	28 lbs.	<b>980</b>
<b>HWBLIBRT-FULD</b>	Insulated Bottom Mount Only w/Drain	13 <sup>7</sup> / <sub>8</sub> " x 22 <sup>1</sup> / <sub>8</sub> " x 10 <sup>5</sup> / <sub>16</sub> "	120	750	26 lbs.	<b>1033</b>
<b>Standard Watt</b>						
<b>HWBRT-FUL</b>	Uninsulated Top or Bottom Mount	13 <sup>11</sup> / <sub>16</sub> " x 21 <sup>3</sup> / <sub>4</sub> " x 9 <sup>3</sup> / <sub>8</sub> "	120, 208 or 240	1200	19 lbs.	<b>\$ 850</b>
<b>HWBRT-FULD</b>	Uninsulated Top or Bottom Mount w/Drain	13 <sup>11</sup> / <sub>16</sub> " x 21 <sup>3</sup> / <sub>4</sub> " x 9 <sup>3</sup> / <sub>8</sub> "	120, 208 or 240	1200	20 lbs.	<b>903</b>
<b>HWBRN-FUL</b>	Uninsulated Top or Bottom Mount	13 <sup>11</sup> / <sub>16</sub> " x 21 <sup>3</sup> / <sub>4</sub> " x 9 <sup>3</sup> / <sub>8</sub> "	120, 208 or 240	1200	19 lbs.	<b>850</b>
<b>HWBRN-FULD</b>	Uninsulated Top or Bottom Mount w/Drain	13 <sup>11</sup> / <sub>16</sub> " x 21 <sup>3</sup> / <sub>4</sub> " x 9 <sup>3</sup> / <sub>8</sub> "	120, 208 or 240	1200	20 lbs.	<b>903</b>
<b>HWBIRT-FUL</b>	Insulated Top or Bottom Mount	13 <sup>11</sup> / <sub>16</sub> " x 21 <sup>3</sup> / <sub>4</sub> " x 10 <sup>5</sup> / <sub>16</sub> "	120, 208 or 240	1200	24 lbs.	<b>980</b>
<b>HWBIRT-FULD</b>	Insulated Top or Bottom Mount w/Drain	13 <sup>11</sup> / <sub>16</sub> " x 21 <sup>3</sup> / <sub>4</sub> " x 10 <sup>5</sup> / <sub>16</sub> "	120, 208 or 240	1200	26 lbs.	<b>1033</b>
<b>HWBIBRT-FUL</b>	Insulated Bottom Mount Only	13 <sup>7</sup> / <sub>8</sub> " x 22 <sup>1</sup> / <sub>8</sub> " x 10 <sup>5</sup> / <sub>16</sub> "	120, 208 or 240	1200	26 lbs.	<b>980</b>
<b>HWBIBRT-FULD</b>	Insulated Bottom Mount Only w/Drain	13 <sup>7</sup> / <sub>8</sub> " x 22 <sup>1</sup> / <sub>8</sub> " x 10 <sup>5</sup> / <sub>16</sub> "	120, 208 or 240	1200	26 lbs.	<b>1033</b>
<b>High Watt</b>						
<b>HWBHRT-FUL</b>	Uninsulated Top or Bottom Mount	13 <sup>11</sup> / <sub>16</sub> " x 21 <sup>3</sup> / <sub>4</sub> " x 9 <sup>3</sup> / <sub>8</sub> "	120, 208 or 240	1650	21 lbs.	<b>\$ 850</b>
<b>HWBHRT-FULD</b>	Uninsulated Top or Bottom Mount w/Drain	13 <sup>11</sup> / <sub>16</sub> " x 21 <sup>3</sup> / <sub>4</sub> " x 9 <sup>3</sup> / <sub>8</sub> "	120, 208 or 240	1650	18 lbs.	<b>903</b>
<b>HWBHRN-FUL</b>	Uninsulated Top or Bottom Mount	13 <sup>11</sup> / <sub>16</sub> " x 21 <sup>3</sup> / <sub>4</sub> " x 9 <sup>3</sup> / <sub>8</sub> "	208 or 240	1650	21 lbs.	<b>850</b>
<b>HWBHRN-FULD</b>	Uninsulated Top or Bottom Mount w/Drain	13 <sup>11</sup> / <sub>16</sub> " x 21 <sup>3</sup> / <sub>4</sub> " x 9 <sup>3</sup> / <sub>8</sub> "	208 or 240	1650	20 lbs.	<b>903</b>
<b>HWBHIRT-FUL</b>	Insulated Top or Bottom Mount	13 <sup>11</sup> / <sub>16</sub> " x 21 <sup>3</sup> / <sub>4</sub> " x 10 <sup>5</sup> / <sub>16</sub> "	120, 208 or 240	1650	26 lbs.	<b>980</b>
<b>HWBHIRT-FULD</b>	Insulated Top or Bottom Mount w/Drain	13 <sup>11</sup> / <sub>16</sub> " x 21 <sup>3</sup> / <sub>4</sub> " x 10 <sup>5</sup> / <sub>16</sub> "	120, 208 or 240	1650	28 lbs.	<b>1033</b>
<b>HWBIBRT-FUL</b>	Insulated Bottom Mount Only	13 <sup>7</sup> / <sub>8</sub> " x 22 <sup>1</sup> / <sub>8</sub> " x 10 <sup>5</sup> / <sub>16</sub> "	120, 208 or 240	1650	28 lbs.	<b>980</b>
<b>HWBIBRT-FULD</b>	Insulated Bottom Mount Only w/Drain	13 <sup>7</sup> / <sub>8</sub> " x 22 <sup>1</sup> / <sub>8</sub> " x 10 <sup>5</sup> / <sub>16</sub> "	120, 208 or 240	1650	28 lbs.	<b>1033</b>

- "RT" added to model name indicates unit with thermostat control, lit rocker switch and 36" capillary.
- "RN" added to model name indicates unit with infinite switch control, pilot light and 36" leads.

#### All Built-In Full-Size Rectangular UR and C-UR Heated Well Models Feature:

**Voltage:** Single phase.

**Models Shipped with:** EZ locking hardware for installation (top mounted only).

#### OPTIONS (available at time of purchase only), UR and C-UR COMPONENTS ONLY

<b>HWB-LEAD-UR</b>	Power Supply Lead Wire for "RN" Components (Lead Wire only - Conduit not included)	<b>per foot \$ 14</b>
<b>HWB-SQUARE</b>	Square Pan Corners (In lieu of standard round pan corners)	<b>add 106</b>
<b>Control Options -</b>		
<b>HWB-TSTAT-UR</b>	Thermostat with 6' Capillary for "RT" Components (in lieu of standard 3', Thermostat only - Conduit not included)	<b>\$68</b>

#### Standard Corner



#### Square Corner

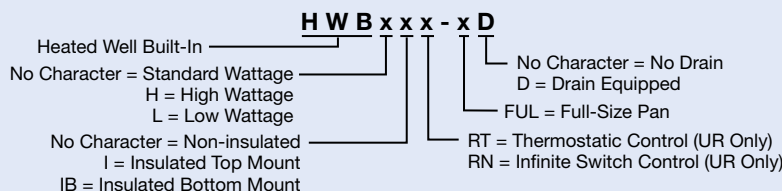

**COUNTERTOP CUT-OUT DIMENSIONS - PAGE 49**  
**ACCESSORIES - PAGES 58-59**



## Drop-In 4/3-Size Heated Wells – UR and C-UR Components

Having the same great features as all of the Hatco Heated Wells, plus the added benefit of allowing fabricators the freedom to design their own steam tables with UL recognized components, these units hold hot food products at safe-serving temperatures.

- Without conduit and control box enclosure
- Thermostatic or infinite controls available (infinite switch option not available on 120V high watt)
- With or without drains
- Low, standard and high watt models



**HWBRT-43D** with accessory food pans (single unit can hold 4 third-size pans)

## Control Options

The UR and C-UR models can have the following control choices:

- Thermostatic controls, which feature an On/Off switch with light
- Infinite controls – available with indicator light (infinite switch option not available on 120V high watt)



Thermostatic control



Infinite control

## CONTROL CUTOUT DIMENSIONS

Control	Width	Height
Thermostatic	2 1/8"	3 3/8"
Infinite	2 1/8"	3 3/8"

**NOTE:** Fabricators will need to obtain UL approvals.

### DROP-IN 4/3-SIZE RECTANGULAR WELLS UR AND C-UR COMPONENTS

Model #	Description	Dimensions W x D x H	Voltage	Watts	Approx. Ship Weight	List Price
<b>Low Watt</b>						
<b>HWBLRT-43</b>	Uninsulated	13 5/8" x 28 5/8" x 9 3/8"	120	750	30 lbs.	<b>\$ 958</b>
<b>HWBLRT-43D</b>	Uninsulated w/Drain	13 5/8" x 28 5/8" x 9 3/8"	120	750	33 lbs.	<b>1011</b>
<b>HWBLRN-43</b>	Uninsulated	13 5/8" x 28 5/8" x 9 3/8"	120	750	21 lbs.	<b>958</b>
<b>HWBLRN-43D</b>	Uninsulated w/Drain	13 5/8" x 28 5/8" x 9 3/8"	120	750	33 lbs.	<b>1011</b>
<b>Standard Watt</b>						
<b>HWBRT-43</b>	Uninsulated	13 5/8" x 28 5/8" x 9 3/8"	120, 208 or 240	1200	23 lbs.	<b>\$ 958</b>
<b>HWBRT-43D</b>	Uninsulated w/Drain	13 5/8" x 28 5/8" x 9 3/8"	120, 208 or 240	1200	21 lbs.	<b>1011</b>
<b>HWBRN-43</b>	Uninsulated	13 5/8" x 28 5/8" x 9 3/8"	120, 208 or 240	1200	21 lbs.	<b>958</b>
<b>HWBRN-43D</b>	Uninsulated w/Drain	13 5/8" x 28 5/8" x 9 3/8"	120, 208 or 240	1200	21 lbs.	<b>1011</b>
<b>High Watt</b>						
<b>HWBHRT-43</b>	Uninsulated	13 5/8" x 28 5/8" x 9 3/8"	120, 208 or 240	1650	30 lbs.	<b>\$ 958</b>
<b>HWBHRT-43D</b>	Uninsulated w/Drain	13 5/8" x 28 5/8" x 9 3/8"	120, 208 or 240	1650	21 lbs.	<b>1011</b>
<b>HWBHRN-43</b>	Uninsulated	13 5/8" x 28 5/8" x 9 3/8"	208 or 240	1650	30 lbs.	<b>958</b>
<b>HWBHRN-43D</b>	Uninsulated w/Drain	13 5/8" x 28 5/8" x 9 3/8"	208 or 240	1650	33 lbs.	<b>1011</b>

- "RT" added to model name indicates unit with thermostat control, lit rocker switch and 36" capillary.
- "RN" added to model name indicates unit with infinite switch control, pilot light and 36" leads.

**All Drop-In 4/3-Size Rectangular UR and C-UR Heated Well Models Feature:**

**Voltage:** Single phase.

**Models Shipped with:** EZ locking hardware for installation.

### OPTIONS (available at time of purchase only), UR and C-UR COMPONENTS ONLY

<b>HWB-LEAD-UR</b>	Power Supply Lead Wire for "RN" Components (Lead Wire only – Conduit not included)	<b>per foot \$14</b>
<b>Control Options –</b>		
<b>HWB-TSTAT-UR</b>	Thermostat with 6' Capillary for "RT" Components (in lieu of standard 3', Thermostat only – Conduit not included)	<b>68</b>

#### H W B x x - x D

Heated Well Built-In	H	W	B	x	x	-	x	D
No Character = Standard Wattage								
H = High Wattage								
L = Low Wattage								
No Character = No Drain								D
D = Drain Equipped								
43 = 4/3-Size Pan								
RT = Thermostatic Control (UR only)								
RN = Infinite Switch Control (UR only)								

**COUNTERTOP CUT-OUT DIMENSIONS – PAGE 49**  
**ACCESSORIES – PAGES 58-59**



## Drop-In Round Heated Wells - UR and C-UR Components

Ideal for the fabricator who wants to design a specific steam table layout. Easy to install, and easy to service, the Round Heated Wells come with control, size, drain and wattage choices.

- 4-, 7- and 11-quart Round Heated Wells
- Standard or high watt (4-quart standard watt only)
- With or without drain
- Thermostatic or infinite controls available
- Without conduit and control box enclosure

HWBRT-7QT with accessory food pan (not included)



HWBRT-11QT with accessory food pan (not included)

HWBRT-4QT with accessory food pan (not included)

Wells

**NOTE:** Fabricators will need to obtain UL approvals.

### DROP-IN ROUND WELLS UR AND C-UR COMPONENTS – UNINSULATED

Model #	Description	Dimensions Dia. x H	Watts			Approx. Ship Weight	List Price
			120V	208V	240V		
<b>4-Quart – Standard Watt</b>							
HWBRT-4QT	Top Mount	8 <sup>3</sup> / <sub>16</sub> " x 10 <sup>5</sup> / <sub>16</sub> "	500	536	600	9 lbs.	<b>\$804</b>
HWBRT-4QTD	Top Mount w/Drain	8 <sup>3</sup> / <sub>16</sub> " x 10 <sup>5</sup> / <sub>16</sub> "	500	536	600	9 lbs.	<b>857</b>
HWBRN-4QT	Top Mount	8 <sup>3</sup> / <sub>16</sub> " x 10 <sup>5</sup> / <sub>16</sub> "	500	536	600	6 lbs.	<b>804</b>
HWBRN-4QTD	Top Mount w/Drain	8 <sup>3</sup> / <sub>16</sub> " x 10 <sup>5</sup> / <sub>16</sub> "	500	536	600	10 lbs.	<b>857</b>
<b>7-Quart – Standard Watt</b>							
HWBRT-7QT	Top Mount	10 <sup>5</sup> / <sub>16</sub> " x 9 <sup>9</sup> / <sub>16</sub> "	500	536	600	11 lbs.	<b>\$804</b>
HWBRT-7QTD	Top Mount w/Drain	10 <sup>5</sup> / <sub>16</sub> " x 9 <sup>9</sup> / <sub>16</sub> "	500	536	600	11 lbs.	<b>857</b>
HWBRN-7QT	Top Mount	10 <sup>5</sup> / <sub>16</sub> " x 9 <sup>9</sup> / <sub>16</sub> "	500	536	600	7 lbs.	<b>804</b>
HWBRN-7QTD	Top Mount w/Drain	10 <sup>5</sup> / <sub>16</sub> " x 9 <sup>9</sup> / <sub>16</sub> "	500	536	600	10 lbs.	<b>857</b>
<b>7-Quart – High Watt</b>							
HWBHRT-7QT	Top Mount	10 <sup>5</sup> / <sub>16</sub> " x 9 <sup>9</sup> / <sub>16</sub> "	800	715	800	11 lbs.	<b>\$804</b>
HWBHRT-7QTD	Top Mount w/Drain	10 <sup>5</sup> / <sub>16</sub> " x 9 <sup>9</sup> / <sub>16</sub> "	800	715	800	9 lbs.	<b>857</b>
HWBHRN-7QT	Top Mount	10 <sup>5</sup> / <sub>16</sub> " x 9 <sup>9</sup> / <sub>16</sub> "	800	715	800	7 lbs.	<b>804</b>
HWBHRN-7QTD	Top Mount w/Drain	10 <sup>5</sup> / <sub>16</sub> " x 9 <sup>9</sup> / <sub>16</sub> "	800	715	800	13 lbs.	<b>857</b>
<b>11-Quart – Standard Watt</b>							
HWBRT-11QT	Top Mount	12 <sup>5</sup> / <sub>16</sub> " x 9 <sup>5</sup> / <sub>16</sub> "	500	536	600	10 lbs.	<b>\$804</b>
HWBRT-11QTD	Top Mount w/Drain	12 <sup>5</sup> / <sub>16</sub> " x 9 <sup>5</sup> / <sub>16</sub> "	500	536	600	11 lbs.	<b>857</b>
HWBRN-11QT	Top Mount	12 <sup>5</sup> / <sub>16</sub> " x 9 <sup>5</sup> / <sub>16</sub> "	500	536	600	10 lbs.	<b>804</b>
HWBRN-11QTD	Top Mount w/Drain	12 <sup>5</sup> / <sub>16</sub> " x 9 <sup>5</sup> / <sub>16</sub> "	500	536	600	11 lbs.	<b>857</b>
<b>11-Quart – High Watt</b>							
HWBHRT-11QT	Top Mount	12 <sup>5</sup> / <sub>16</sub> " x 9 <sup>5</sup> / <sub>16</sub> "	800	715	800	15 lbs.	<b>\$804</b>
HWBHRT-11QTD	Top Mount w/Drain	12 <sup>5</sup> / <sub>16</sub> " x 9 <sup>5</sup> / <sub>16</sub> "	800	715	800	11 lbs.	<b>857</b>
HWBHRN-11QT	Top Mount	12 <sup>5</sup> / <sub>16</sub> " x 9 <sup>5</sup> / <sub>16</sub> "	800	715	800	10 lbs.	<b>804</b>
HWBHRN-11QTD	Top Mount w/Drain	12 <sup>5</sup> / <sub>16</sub> " x 9 <sup>5</sup> / <sub>16</sub> "	800	715	800	13 lbs.	<b>857</b>

- "RT" added to model name indicates unit with thermostatic control, lit rocker switch and 36" capillary.
- "RN" added to model name indicates unit with infinite switch control, pilot light and 36" leads.

**All Drop-In Round UR and C-UR Heated Well Models Feature:**

**Voltage:** Single phase.

**Models Shipped with:** EZ locking hardware for installation.

## Control Options

The UR and C-UR models can have the following control choices:

- Thermostatic controls, which feature an On/Off switch with light
- Infinite controls – available with indicator light



Thermostatic control



Infinite control

### CONTROL CUTOUT DIMENSIONS

Control	Width	Height
Thermostatic	2 <sup>1</sup> / <sub>8</sub> "	3 <sup>3</sup> / <sub>8</sub> "
Infinite	2 <sup>1</sup> / <sub>8</sub> "	3 <sup>3</sup> / <sub>8</sub> "

### OPTIONS (available at time of purchase only), UR and C-UR COMPONENTS ONLY

<b>HWB-LEAD-UR</b>	Power Supply Lead Wire for "RN" Components (Lead Wire only – Conduit not included)	<b>per foot \$14</b>
<b>Control Options –</b>		
<b>HWB-TSTAT-UR</b>	Thermostat with 6' Capillary for "RT" Components (in lieu of standard 3', Thermostat only – Conduit not included)	<b>\$68</b>

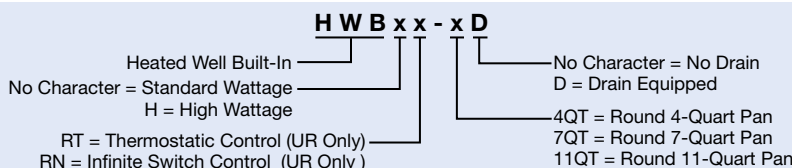

**COUNTERTOP CUT-OUT DIMENSIONS – PAGE 49**  
**ACCESSORIES – PAGES 58-59**

## Drop-In Hot/Cold Well and Heated Well Accessories

(available for purchase at any time)

Wells



**FTB-2**  
with accessory  
full-size  
sheet pans

**HWBI-2**  
with accessory  
half and third-size  
food pans

### PANS – LIDS – TRIVETS

<b>ST PAN 1/3</b>	Third-Size Stainless Steel Pan – 12 <sup>3</sup> / <sub>4</sub> "W x 6 <sup>7</sup> / <sub>8</sub> "D x 2 <sup>1</sup> / <sub>2</sub> "H	<b>\$ 68</b>
<b>ST PAN 1/2</b>	Half-Size Stainless Steel Pan – 12 <sup>3</sup> / <sub>4</sub> "W x 10 <sup>3</sup> / <sub>8</sub> "D x 2 <sup>1</sup> / <sub>2</sub> "H	<b>78</b>
<b>ST PAN 2</b>	Full-Size Stainless Steel Pan – 12 <sup>3</sup> / <sub>4</sub> "W x 20 <sup>3</sup> / <sub>4</sub> "D x 2 <sup>1</sup> / <sub>2</sub> "H	<b>93</b>
<b>ST PAN 4</b>	Full-Size Stainless Steel Pan – 12 <sup>3</sup> / <sub>4</sub> "W x 20 <sup>3</sup> / <sub>4</sub> "D x 4"H	<b>117</b>
<b>HDW 6" PAN</b>	Full-Size Stainless Steel Pan – 12 <sup>3</sup> / <sub>4</sub> "W x 20 <sup>3</sup> / <sub>4</sub> "D x 6"H	<b>127</b>
<b>4QT-PAN</b>	4-Quart Round Pan	<b>124</b>
<b>7QT-PAN</b>	7-Quart Round Pan	<b>138</b>
<b>11QT-PAN</b>	11-Quart Round Pan	<b>152</b>
<b>Notched Lid for Round Pans –</b>		
<b>4QT-LID-1</b>	4-Quart Round, Notched, Solid Lid	<b>\$59</b>
<b>7QT-LID-1</b>	7-Quart Round, Notched, Solid Lid	<b>72</b>
<b>11QT-LID-1</b>	11-Quart Round, Notched, Solid Lid	<b>86</b>
<b>Hinged Lid for Round Pans –</b>		
<b>4QT-LID</b>	4-Quart Round, Hinged and Notched Lid	<b>\$ 77</b>
<b>7QT-LID</b>	7-Quart Round, Hinged and Notched Lid	<b>101</b>
<b>11QT-LID</b>	11-Quart Round, Hinged and Notched Lid	<b>126</b>
<b>Wire Trivets Stainless –</b>		
<b>TRIVET (1/2)SS</b>	Half-Size – 10 <sup>1</sup> / <sub>6</sub> "W x 7 <sup>5</sup> / <sub>8</sub> "D	<b>\$126</b>
<b>TRIVET SS</b>	Full-Size – 10 <sup>1</sup> / <sub>6</sub> "W x 18"D	<b>175</b>

**ST PAN 1/3**

**ST PAN 1/2**

**ST PAN 2**

**ST PAN 4**

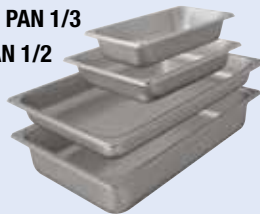

**HDW 6" PAN**

**11QT-PAN**



**4QT-PAN**

**7QT-PAN**

**11QT-LID**

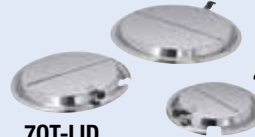

**7QT-LID**

**4QT-LID**

**7QT-LID-1**

**11QT-LID-1**



**4QT-LID-1**

**TRIVET (1/2)SS**

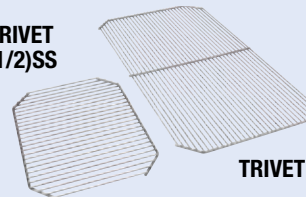

**TRIVET SS**

**ADAPTERS, SUPPORT BARS, MOUNTING KITS, VALVES – PAGE 59**

## Drop-In Hot/Cold Well and Heated Well Accessories

(available for purchase at any time)

**HWB-2-7Q**  
shown with two  
**7QT-PAN** and  
**7QT-LID-1**

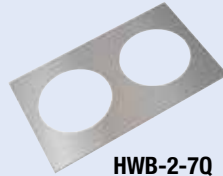

**HWB-2-7Q**



**HWB-2-11Q**



**HWB-3-4Q**

### ADAPTERS – SUPPORT BARS

<b>HWB-2-7Q</b>	Adapter to convert warmer to hold two 7-Quart Inserts (HWB and HWBI Rectangular, HWBI and HWBI-S Modular Heated Wells only)	<b>\$107</b>
<b>HWB-3-4Q</b>	Adapter to convert warmer to hold three 4-Quart Inserts (HWB and HWBI Rectangular, HWBI and HWBI-S Modular Heated Wells only)	<b>107</b>
<b>HWB-2-11Q</b>	Adapter to convert warmer to hold two 11-Quart Inserts (HWB-43 Rectangular and HWBI43 Modular Heated Wells only)	<b>134</b>
<b>HWB12BAR</b>	12" Pan Support Bar for Built-In and Drop-In Heated Wells	<b>23</b>
<b>HWB20BAR</b>	20" Pan Support Bar for Built-In and Drop-In Heated Wells (not available for HWBI-43 series)	<b>27</b>
<b>HWBGM12BAR</b>	12" Pan Support Bar for Drop-In Modular/Ganged Models	<b>23</b>
<b>HWBGM20BAR</b>	20" Pan Support Bar for Drop-In Modular/Ganged Models (not available for HWBI43 series)	<b>27</b>

**Support Bars**  
Choose the appropriate kit for HWBI or HWB series

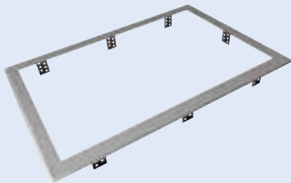
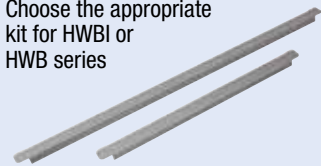

**HWB-FUL-MNT**  
Choose the appropriate kit for HWB-FUL, HWB-43 or HWB-4Q, -7Q, -11Q series

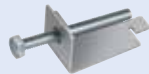

**HWB-MNT-REC** or  
**HWB-MNT-RND**



**HWBI2MANIF**



**BALLVALVE1INCH**

### MOUNTING KITS – VALVES

**Necessary at your Well Installation –**

<b>HWB-FUL-MNT</b>	Mounting Kit for combustibles countertops for HWB-FUL series only	<b>\$137</b>
<b>HWB-43-MNT</b>	Mounting Kit for combustibles countertops for HWB-43 series only	<b>165</b>
<b>HWB-4Q-MNT</b>	Mounting Kit for combustibles countertops for HWB-4Q series only	<b>82</b>
<b>HWB-7Q-MNT</b>	Mounting Kit for combustibles countertops for HWB-7Q series only	<b>89</b>
<b>HWB-11Q-MNT</b>	Mounting Kit for combustibles countertops for HWB-11Q series only	<b>97</b>
<b>HWB-MNT-REC</b>	Kit allows mounting to thick countertops - 8 Brackets (HWBI and HWB Rectangular Heated Wells, HWBI Modular Heated Wells only)	<b>98</b>
<b>HWB-MNT-RND</b>	Kit allows mounting to thick countertops - 4 Bracket (Round Heated Wells only)	<b>49</b>

**External Manifold includes Individual Ball Valve for each Well (HWBI only, not available for the Slim models) –**

<b>HWBI2MANIF</b>	2-Pan Accessory	<b>\$1014</b>
<b>HWBI3MANIF</b>	3-Pan Accessory	<b>1439</b>
<b>HWBI4MANIF</b>	4-Pan Accessory	<b>1864</b>
<b>HWBI5MANIF</b>	5-Pan Accessory	<b>2289</b>
<b>HWBI6MANIF</b>	6-Pan Accessory	<b>2714</b>

**Necessary at your Well Installation –**

<b>BALLVALVE3/4</b>	High Temperature 3/4" NPT Ball Valve for units with Individual Drain(s) and no Manifold	<b>\$128</b>
<b>BALLVALVE1INCH</b>	High Temperature 1" NPT Ball Valve for units with Manifold Drain (Ganged Heated Wells only)	<b>98</b>
<b>GATEVALVE3/4INCH</b>	High Temperature 3/4" NPT Gate Valve for units with Individual Drain(s) and no Manifold	<b>147</b>
<b>GATEVALVE1INCH</b>	High Temperature 1" NPT Gate Valve for units with Manifold Drain (Ganged Heated Wells only)	<b>218</b>
<b>HWB-RDHV</b>	Heated Well Remote Handle for 3/4" Drains only and includes a Ball Valve	<b>505</b>



**GATEVALVE1INCH**

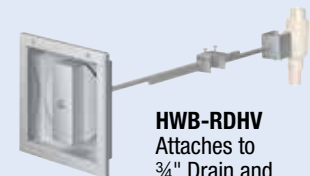

**HWB-RDHV**  
Attaches to 3/4" Drain and includes a Ball Valve



# Decorative Lamps & Display Lights

*Cafeterias • Convenience Stores  
Supermarkets & Delis • Restaurants & Cafés  
Clubs & Bars • Concessions*



**DL-1100-SR** in Clear Brushed Metal  
Gloss finish *pg. 63-66*



**DL-400-SN** in Glossy Gray  
Gloss finish *pg. 63-66*



**DL-400-STR** in Glossy Gray  
Gloss finish *pg. 63-66*



**DL-500-SR** in Bright Brass  
Plated finish *pg. 63-66*



**DL-700-RL** in Glossy Gray Gloss finish  
(sneeze guards not available) *pg. 63-66*



**DL-725-STR** in Bright Nickel  
Plated finish *pg. 63-66*



**DL-750-STR** in Bright Nickel  
Plated finish *pg. 63-66*



**HL5-60** in Standard Clear Anodized finish  
(sneeze guards not available) *pg. 68*





Decorative Lamps & Display Lights

**ORDERING INSTRUCTIONS**

Luminaire lamps are for lighting only. LUMINAIRE option must be specified when lamps are utilized for decorative purposes only (no heating). This option is not field convertible. Maximum 100 watts.

**CLEARANCE REQUIREMENTS**

- NOTE:** Install Standard Watt (120V bulb, 250W) no closer than 3" from a sidewall and no closer than 16" above a combustible surface, or no closer than 5" to a non-combustible surface.
- NOTE:** Install HIGH WATT (120V, 375W bulb) no closer than 3" from a sidewall and no closer than 27" above a combustible surface, or no closer than 17" to a non-combustible surface.
- NOTE:** Multiple installation of Decorative Lamps must have a minimum clearance of 12" on center of shade between each unit.



(From left to right) DL-2300-ASN, -2200-SU, -2100-SR, -1800-RL, -2400-SU, -1600-RCL and -1700-ASU

**Specify the following information with your order:**

1. **Electrical:** Voltage 120V and Wattage 100 (Luminaire), 250 (Standard) or 375 (High)
2. **Mounting Style Code:** AS, AST, RC, RCT, R, RT, S, ST
3. **Switch Location Code:** Lower (L), None (N), Remote (R) or Upper (U). DLH models must have remote switch or none
4. **Shade Style Code:** -400, -500, -600, -700, -725, -750, -760, -775, -800, -1100, -1400, -1500, -1600, -1700, -1800, -2100, -2200, -2300, -2400
5. **Shade and Canopy Colors:** Warm Red, Black, Gray Granite, White Granite, Navy Blue, Hunter Green, Antique Copper, Smooth White, Gleaming Gold, Glossy Gray, Bold Black, Radiant Red (lampshade only), Brilliant Blue\* (lampshade only), Clear Coat Brushed Metal (lampshade only), Bright Brass, Bright Nickel, Bright Copper, Antique Nickel, Antique Brass, Antique Bronze
6. **Overall Unit Length:** For C, CT, S, ST or AS, AST Mounts, from ceiling to bottom of warmer lamp shade
7. **Clearance:** From bulb to surface (see NOTE Clearance Requirements above)
8. **Accessory Bulb Color/Coating:** 40W Clear Coated (Luminaire only), 250W Clear Uncoated, Clear Coated, Red Uncoated or Red Coated, 375W Clear Uncoated, Clear Coated
9. **Optional Cord/Track Color:** Black (standard), White (optional)

- Special process required and extended lead times, see page 65 for additional charge. Specify your appropriate accessories with your order.
- Mounting Style availability dependent on Shade Style type. See pages 63 & 64 for details.

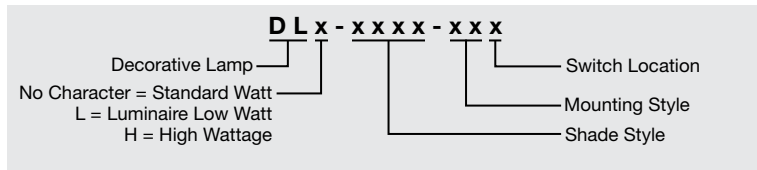
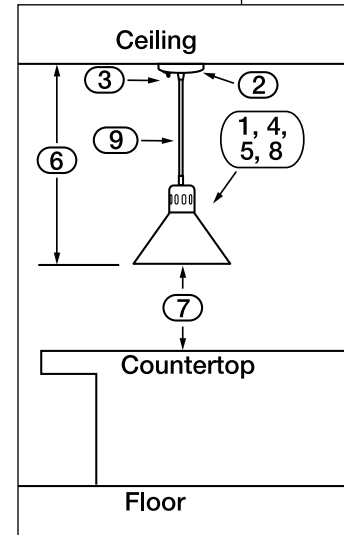

## Decorative Lamps/ Luminaires

Hatco Decorative Lamps provide radiant heat to briefly hold food warm at kitchen work areas, wait staff pickup stations or customer serving points, while enhancing your décor. Versatile enough for any location, the range of lights are available with a selection of personalized choices: shade styles, colors, switch locations and mounting arrangements. Configurations for lighting (Luminaire), as well as foodwarming, are available.

**NOTE:** Decorative Lamps and Luminaires are non-returnable.

- Decorative Lamps and Luminaires available in nineteen shade styles
- Ten different mounting arrangements to choose from
- Seven *Designer* colors, seven Gloss finishes and six Plated finishes available
- Four power switch options:
  - Upper (on canopy)
  - Lower (at stem)
  - Remote
  - None
- Low, standard and high watt bulbs available
- Available for food holding and display or lighting only applications

Rigid and Adjustable Stem Mounts in unit color (except for Gloss finishes Radiant Red, Brilliant Blue and Clear Brushed Metal)

Black or white cord options available. Various cord lengths available, starting at 17", while retractable can vary

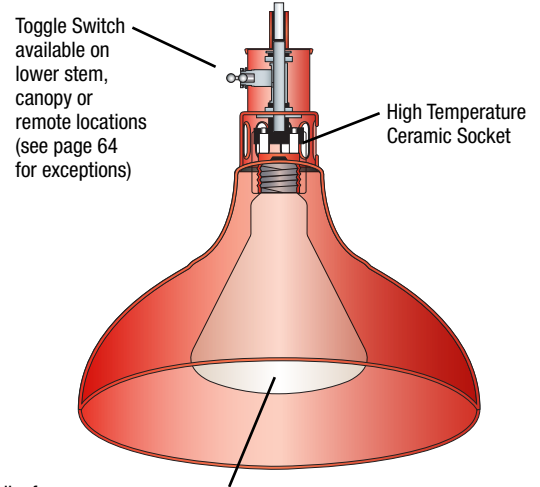

Bulbs for:  
 40W clear, coated (Luminaire only or DLL models)  
 250W (DL models) or 375W (DLH models) in clear, coated or uncoated  
 250W (DL models) red, uncoated or coated

Decorative Lamps & Display Lights

### Build A Decorative Lamp

Hatco has given you a variety of simple and easy ways to "Build Your Decorative Lamp." You can go online or quickly do the work tables of "How to Build Your Lamp" on pages 63 through 66.

- GO online at: [www.hatcocorp.com](http://www.hatcocorp.com) and click on "Product Configurators" than "Build a Lamp" in the header. (*Download a PDF of your lamp configuration in color and a Hatco List Price Quote*)
- OR follow the six steps in the Hatco Price List (next four pages) to build your Hatco model code. Then look at the following page for the accessories, like a bulb or track, to easily complete your total order.

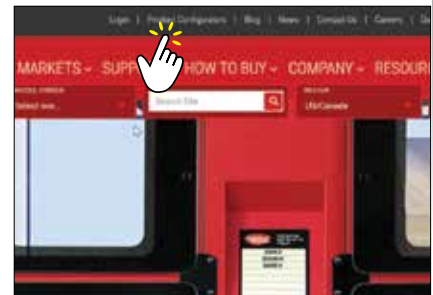

Hatco Website shown, click on "Product Configurators" then "Build A Lamp" in the header to configure your choices



Now you can develop your own Hatco Decorative Lamp solutions with our online lamp configurator.

Visit [www.hatcocorp.com](http://www.hatcocorp.com)  
 Click on "Build a Lamp"

#### HOW TO BUILD A LAMP

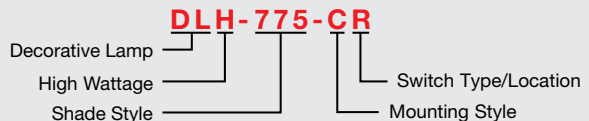

#### Specify the following options when ordering:

1 Electrical	<b>DLH</b>	(High Watt - 375 watt max)	<b>No Charge</b>
2 Mounting Style	<b>C</b>	(Cord Mount)	<b>No Charge</b>
3 Switch Location	<b>R</b>	(Remote Switch Location)	<b>No Charge</b>
4 Shade Style	<b>-775</b>	(See Shade Style on page 65)	<b>\$488</b>
Shade Color	<b>BBRASS</b>	(Bright Brass Plated Finish)	<b>202</b>
6 Overall Length	<b>80"</b>	(Overall Length) - Only C mounts & over 72"	<b>26</b>

(Specify to the nearest inch – CL, CU, CT, ASL, ASU, SL, SU, ST mounts only). **TOTAL \$716**

Information indicated in red are items that the customer must enter.  
 Bulbs are not included.

## Build A Decorative Lamp Configurator Worksheet

Complete the six steps on this worksheet to configure your Hatco model code and list price. In order to get exactly what you need in the least amount of time, have this handy when ordering your Hatco Decorative Lamp.

**BUILD YOUR DECORATIVE/LUMINAIRE LAMPS – STEPS 1 AND 2**  
 (To determine your total list price and model code, pick all your options - bulb not included)



Decorative Lamps & Display Lights

STEP 1: ELECTRICAL		
Voltage	120	
Wattage –		No Charge
DLL- Luminaire	100 watt max	
DL- Standard	250 watt max	
DLH- High Watt	375 watt max	

STEP 2: MOUNTING STYLE		
Mounting Style –		
C <sup>⊗</sup>	Cord (specify Cord Color)	No Charge
CT* <sup>⊗</sup>	Cord Mount to Track Adapter (specify Cord and Track Color)	\$146
R <sup>⊗</sup>	Coiled Retractable Mount (specify Cord Color)	301
RC <sup>⊗</sup>	Retractable Cord (specify Cord Color)	461
RT* <sup>⊗</sup>	Coiled Retractable Mount to Track Adapter (specify Cord and Track Color)	444
RCT* <sup>⊗</sup>	Retractable Cord Mount to Track Adapter (specify Cord and Track Color)	604
S <sup>⊗</sup>	Stem	82

⊗ Not available with a lower switch for DL-2100, -2200, -2300 or -2400  
 ⊗ Not available for DL-2100, -2200, -2300 or -2400  
**\*NOTE:** Lamp shade diameter and wattage may limit number of lamps per track. To ensure warranty coverage, do not install track systems in damp or wet locations (including above steam tables).



DL-1600-RCL shown with Retractable Cord Mount

DL-1800-RL shown with Coiled Retractable Cord Mount

DL x - x x x x - x x x	
Decorative Lamp	Switch Location
No Character = Standard Watt	Mounting Style
L = Luminaire Low Watt	Shade Style
H = High Wattage	

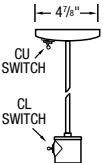
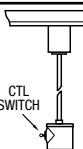
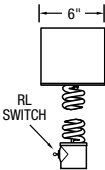
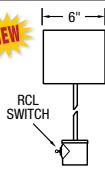
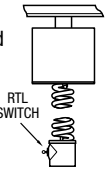
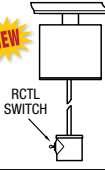
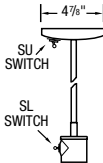
	MOUNTING STYLES	SPECIFY:	Shade Height	
			8½" H	10½" H
CORD	<b>C Mount<sup>⊗</sup></b> Cord Mount to canopy. 	Overall Length	17" to any length	19" to any length
	<b>CT Mount*<sup>⊗</sup></b> Cord Mount to track adapter. 			
RETRACTABLE CORD	<b>R Mount<sup>⊗</sup></b> Coiled Retractable Cord Mount. 	Adjusts to a maximum and minimum according to shade height	31" to 69½"	33" to 71½"
	<b>RC Mount<sup>⊗</sup></b> Retractable Cord Mount. 		24" to 72"	27" to 75"
	<b>RT Mount*<sup>⊗</sup></b> Coiled Retractable Cord Mount to track adapter. 		33⅜" to 71⅞"	35⅜" to 73⅞"
	<b>RCT Mount*<sup>⊗</sup></b> Retractable Cord Mount to track adapter. 		27" to 75"	29" to 77"
	<b>S Mount<sup>⊗</sup></b> Rigid Stem Mount to canopy. 		Overall Length	14" to 71"

**NOTE:** Decorative Lamps and Luminaires are non-returnable.

Go to next page to Continue Step 2 (Stem and Adjustable Stem Mounts) and for Step 3.

# Build A Decorative Lamp Configurator Worksheet

Continued from page 63



Visit [www.hatco.com](http://www.hatco.com)  
Click on "Build a Lamp"

## BUILD YOUR DECORATIVE/LUMINAIRE LAMPS – STEPS 2 AND 3 (To determine your total list price and model code, pick all your options - bulb not included)

Decorative Lamps & Display Lights

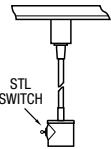
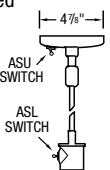
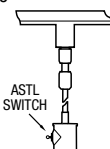
MOUNTING STYLES				
Review Switch Locations below in Step 3 to determine your appropriate model code.		SPECIFY:	Shade Height	
			8½" H	10½" H
STEM	<b>ST Mount*</b> Rigid Stem Mount to track adapter. 	Overall Length	17" to 71"	19" to 73"
	<b>AS Mount</b> At install only, limited height adjustments with Rigid Stem Mount to canopy. 		<b>ASU, ASR, ASN</b> 14" to 16"    16" to 18" 16" to 19½"    18" to 21½" 20" to 27"    22" to 29" 27" to 42"    29" to 44" 42" to 72"    44" to 74"	
ADJUSTABLE	<b>AST Mount*</b> At install only, limited height adjustments with Rigid Stem Mount to track adapter. 	Adjustable Overall Length (at install only)	<b>ASL</b> 16" to 17"    18" to 19" 18" to 22"    20" to 24" 22" to 28"    24" to 30" 29" to 43"    31" to 45" 44" to 73"    46" to 75"	
			<b>ASTR, ASTN</b> 16" to 18"    18" to 20" 18" to 21"    20" to 23" 22" to 29"    24" to 31" 30" to 44"    32" to 46" 45" to 74"    47" to 76"	
	<b>ASTL</b> 18" to 19"    20" to 21" 20" to 23"    22" to 25" 24" to 31"    26" to 33" 31" to 45"    33" to 47" 46" to 75"    48" to 77"			

### STEP 2: MOUNTING STYLE – continued

Mounting Style –		
<b>ST*</b>	Stem to Track Adapter	225
<b>AS</b>	Adjustable Stem Mount (Limited height adjustment at install only, mount with rigid stem mount to canopy)	\$184
<b>AST*</b>	Adjustable Stem Track Mount (Limited height adjustment at install only, mount with rigid stem mount to track adapter)	316

⊙ Not available with a lower switch for DL-2100, -2200, -2300 or -2400  
**\* NOTE:** Lamp shade diameter and wattage may limit number of lamps per track. To ensure warranty coverage, do not install track systems in damp or wet locations (including above steam tables).

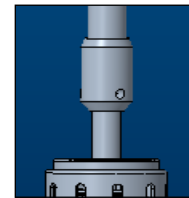

**Aluminum Plated Coupler** provides a high strength hold for the Adjustable Stem Mount

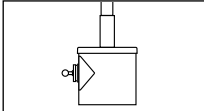
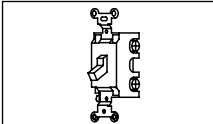
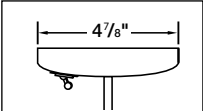
SWITCH LOCATIONS		
 <p><b>L - Lower Switch</b> Not available on:                      • DLH (high watt models)                      • Not available for DL-2100, -2200, -2300 or -2400.</p>	 <p><b>R - Remote Switch</b>                      • Accommodates 16 amps                      • Up to seven 250W lamps, or five 375W lamps maximum per remote switch</p>	 <p><b>U - Upper Switch</b> Not available on:                      • DLH (high watt models)                      • R, RC Mounts                      • Track mounts (CT, RT, RCT, ST, AST)</p>

### STEP 3: SWITCH LOCATION

Switch Location –		No Charge
<b>L</b>	<b>Lower</b> (not available on high watt models)	
<b>N</b>	<b>None</b>	
<b>R</b>	<b>Remote</b>	
<b>U</b>	<b>Upper</b> (not available on high watt models)	

**Go to next page for Steps 4 and Steps 5.**

**NOTE:** Decorative Lamps and Luminaires are non-returnable.

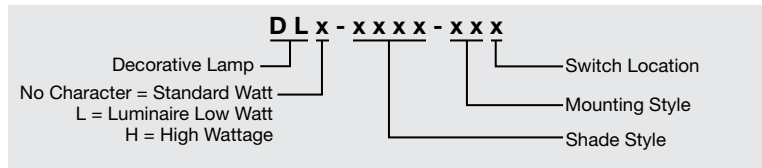



# Build A Decorative Lamp Configurator Worksheet

Continued from page 64

## BUILD YOUR DECORATIVE/LUMINAIRE LAMPS – STEPS 3 AND 4

(To determine your total list price and model code, pick all your options - bulb not included)



### SHADE STYLES (height and width shown)

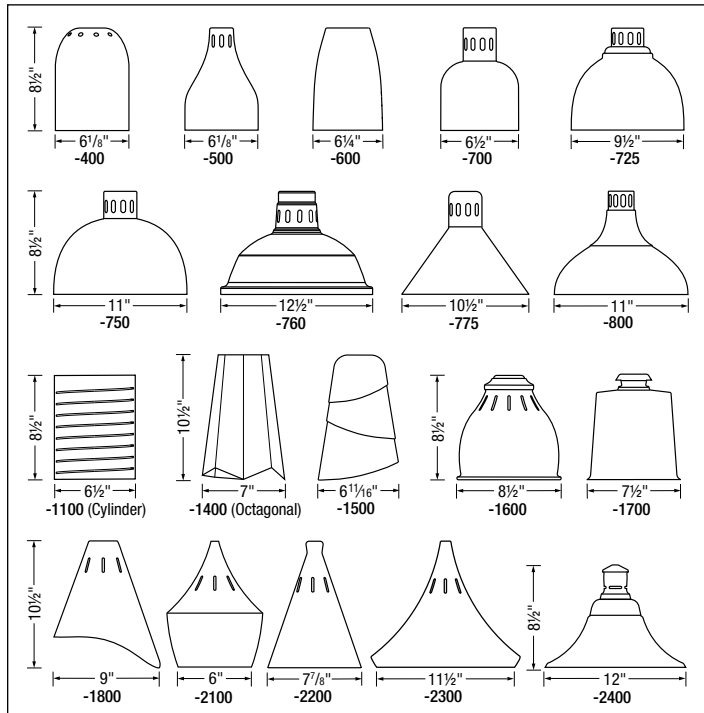

### STEP 4: SHADE STYLE

Shade Code	Approx. Ship Weight (depending on components)	List Price
-400	6-10 lbs.	\$446
-500	6-10 lbs.	446
-600	6-10 lbs.	446
-700	6-10 lbs.	446
-725	6-10 lbs.	\$488
-750	6-10 lbs.	488
-760	6-10 lbs.	488
-775	6-10 lbs.	488
-800	6-10 lbs.	488
-1100	6-10 lbs.	488
-1400	6-10 lbs.	488
-1500	6-10 lbs.	\$555
-1600	6-10 lbs.	488
-1700	6-10 lbs.	488
-1800	6-10 lbs.	488
-2100	6-10 lbs.	\$425
-2200	6-10 lbs.	425
-2300	6-10 lbs.	425
-2400	6-10 lbs.	425

Decorative Lamps & Display Lights

### SHADE AND CANOPY COLORS

**Designer Colors**

**Gloss Finishes**

**Gloss Finishes for Shade Only – Special Process Required and Extended Lead Times**

*Printed colors are a representation and may not exactly match our Designer, Gloss and Plated Finishes.*

### STEP 5: SHADE AND CANOPY COLORS\*

Designer Colors		No Charge
<b>RED</b>	Warm Red	<b>NAVY</b> Navy Blue
<b>BLACK</b>	Black	<b>GREEN</b> Hunter Green
<b>GRAY</b>	Gray Granite	<b>COPPER</b> Antique Copper
<b>WHITE</b>	White Granite	
Gloss Finishes		No Charge
<b>SWHITE</b>	Smooth White	<b>GGRAY</b> Glossy Gray
<b>GGOLD</b>	Gleaming Gold	<b>BBLACK</b> Bold Black
* Gloss Finishes for Shade Only – (must choose other finish for remainder of unit) – Special Process Required and Extended Lead Times –		
<b>RRED</b>	Radiant Red	
<b>BBLUE</b>	Brilliant Blue	
<b>CL-COAT</b>	Clear Brushed Metal	

Go to next page to Continue Step 5 (Plated Finishes) and for Step 6.

**NOTE:** Decorative Lamps and Luminaires are non-returnable.

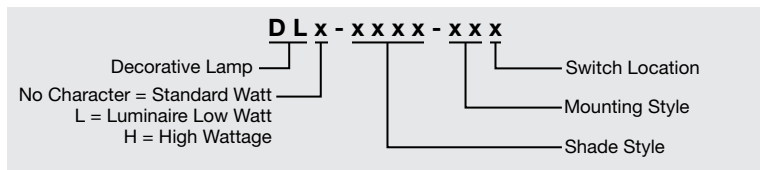



# Build A Decorative Lamp Configurator Worksheet

Continued from page 65

**BUILD YOUR DECORATIVE/LUMINAIRE LAMPS – STEPS 5 AND 6**  
(To determine your total list price and model code, pick all your options - bulb not included)



Visit [www.hatcocorp.com](http://www.hatcocorp.com)  
Click on "Build a Lamp"

## STEP 5: SHADE AND CANOPY COLORS\*

Plated Finishes –  
Special Process Required and Extended Lead Times –

<b>B</b> BRASS	Bright Brass	<b>\$202</b>
<b>B</b> NICKEL	Bright Nickel	<b>202</b>
<b>B</b> COPPER	Bright Copper	<b>202</b>
<b>A</b> NICKEL	Antique Nickel	<b>202</b>
<b>A</b> BRASS	Antique Brass	<b>202</b>
<b>A</b> BRONZE	Antique Bronze	<b>202</b>

Plated Finishes – Special Process Required and Extended Lead Times



\* Exception: DL-1500 for Shade Only –



\* Gloss and Plated Finishes – Special Process Required and Extended Lead Times

Printed colors are a representation and may not exactly match our Designer, Gloss and Plated Finishes.

## STEP 6: OVERALL LENGTH

Overall Length – For C or CT Mounts from ceiling to bottom of lamp shade.

Up to 72"	No Charge
Greater than 72" (C or CT Mount only)	\$26

Decorative Lamps & Display Lights

## YOUR TOTAL LIST PRICE AND MODEL CODE

Add the total costs of options below (not for retrofit – bulb not included) –

<b>Step 1</b>	Electrical	<b>\$ 0.00</b>
<b>Step 2</b>	Mounting Style	
<b>Step 3</b>	Switch Location	<b>0.00</b>
<b>Step 4</b>	Shade Style	
<b>Step 5</b>	Shade and Canopy Colors	
<b>Step 6</b>	Overall Length	

Your Total Price \$

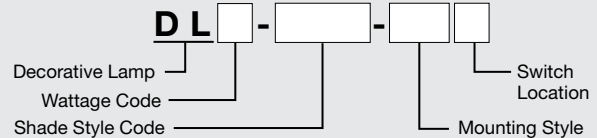

**NOTE:** Decorative Lamps and Luminaires are non-returnable.

**BULBS AND ACCESSORIES – PAGE 67**

**D L x - x x x x - x x x**

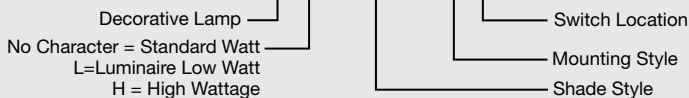



**TRACK INSTALLATION AND MODIFICATION KIT –**  
Highlighted components (for cutting Track Length into multiple sections)

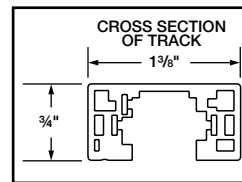
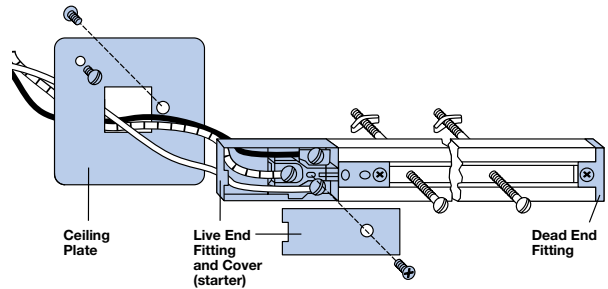

**NOTE:** Decorative Lamps and Luminares are non-returnable.

Decorative Lamps & Display Lights

**OPTIONS** (available at time of purchase only)

<b>DL-CORD-BK</b>	Black Cord – Standard (C=Cord, R=Retractable Mounts Only)	<b>No Charge</b>
<b>DL-CORD-WHITE</b>	White Cord (C=Cord, R=Retractable Mounts Only)	<b>No Charge</b>
<b>Leads – For any Stem Mount or Adjustable Stem Mount unit, must specify Lead Length –</b>		
<b>LEADS5</b>	1'-5' Extended Electrical Leads	<b>\$ 29</b>
<b>LEADS10</b>	6'-10' Extended Electrical Leads	<b>58</b>
<b>LEADS15</b>	11'-15' Extended Electrical Leads	<b>87</b>
<b>LEADS20</b>	16'-20' Extended Electrical Leads	<b>116</b>

**ACCESSORIES** (available for purchase at any time)

<b>DL-TRACK-4B</b>	4' Track Mount Bar, Black <sup>△</sup> =	<b>\$302</b>
<b>DL-TRACK-4W</b>	4' Track Mount Bar, White <sup>△</sup> =	<b>302</b>
<b>DL-TRACK-8B</b>	Two 4' Track Mount Bars with Couplers, Black <sup>△</sup> = <sup>○</sup>	<b>454</b>
<b>DL-TRACK-8W</b>	Two 4' Track Mount Bars with Couplers, White <sup>△</sup> = <sup>○</sup>	<b>454</b>
<b>DL-TRACK-12B</b>	Three 4' Track Mount Bars with Couplers, Black <sup>△</sup> = <sup>○</sup>	<b>644</b>
<b>DL-TRACK-12W</b>	Three 4' Track Mount Bars with Couplers, White <sup>△</sup> = <sup>○</sup>	<b>644</b>
<b>DL-TRACK-16B</b>	Four 4' Track Mount Bars with Couplers, Black <sup>△</sup> = <sup>○</sup>	<b>796</b>
<b>DL-TRACK-16W</b>	Four 4' Track Mount Bars with Couplers, White <sup>△</sup> = <sup>○</sup>	<b>796</b>
<b>DL-TRACKBLK</b>	Additional Track Installation and Modification Kit (includes Ceiling Plate, Live End Fitting and Cover (Starter) and Dead End Fitting) – Black (For cutting Track Length into multiple sections, see above)	<b>121</b>
<b>DL-TRACKWHT</b>	Additional Track Installation and Modification Kit (includes Ceiling Plate, Live End Fitting and Cover (Starter) and Dead End Fitting) – White (For cutting Track Length into multiple sections, see above)	<b>121</b>
<b>DL-SWITCH-16AMP</b>	16 Amp Lamp Toggle Switch	<b>each 23</b>
<b>WHITE-CTD-120L</b>	120 Volt, 40 Watt Clear Bulb, Coated (Luminaire models only)	<b>each 17</b>
<b>WHITE-UCTD-120</b>	120 Volt, 250 Watt Clear Bulb, Uncoated	<b>each 28</b>
<b>WHITE-UCTD-120H</b>	120 Volt, 375 Watt Clear Bulb, Uncoated (high watt models only)	<b>each 50</b>
<b>WHITE-CTD-120</b>	120 Volt, 250 Watt Clear Bulb, Coated	<b>each 40</b>
<b>WHITE-CTD-120H</b>	120 Volt, 375 Watt Clear Bulb, Coated (high watt models only)	<b>each 65</b>
<b>RED-UCTD-120</b>	120 Volt, 250 Watt Red Bulb, Uncoated	<b>each 39</b>
<b>RED-CTD-120</b>	120 Volt, 250 Watt Red Bulb, Coated	<b>each 50</b>

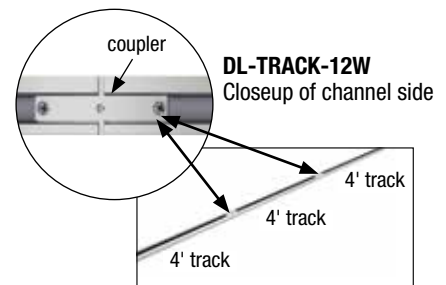

**RED** uncoated, **WHITE** uncoated,  
**RED** coated, **WHITE** coated



= Tracks may be cut to fit any length by installer. Modification kits available.  
<sup>△</sup> Maximum seven (7) 250 watt lamps or five (5) 375 watt lamps per 20 amp Track Bar Circuit. Maximum 1920 watts or 16 amps per any length track. Installer is responsible for properly sizing the supply circuit and the lamp load. Lamp shade diameter and wattage may limit number of lamps per track.  
<sup>○</sup> Overall length may not add up to the exact desired size for 8', 12' or 16' due to cumulative deductions for each 4' section used.



# Glo-Rite® Curved Display Lights

A stylish choice for illuminating your serving area. The Glo-Rite® Curved Display Light offers the highest light output that is ideal for illuminating food products with either a warm white light (3050K) or a cool or neutral white light (4100K).

Hatco provides you with a wide variety of colors and lengths for any serving area.

- Features a patented curved housing design with energy efficient dual LED lights across the display lamp that provide longer performance and energy savings (compared to standard incandescent bulbs)

- Field replaceable dual LED lights
- Matches the Hatco line of Glo-Ray® Curved Infrared Strip Heaters for a fully integrated look
- Angle brackets and 6" LED leads are standard
- Optional non-adjustable tubular stands and top or bottom mounting stands available

## GLO-RITE® CURVED DISPLAY LIGHTS

Model	Width	Voltage Single Phase	Watts	Approx. Ship Weight	List Price
HL5-18	18"	120	4.3	9 lbs.	\$1199
HL5-24	24"	120	5.9	12 lbs.	1308
HL5-30	30"	120	7.6	12 lbs.	1417
HL5-36	36"	120	9.2	12 lbs.	1526
HL5-42	42"	120	10.8	14 lbs.	1635
HL5-48	48"	120	12.4	16 lbs.	1744
HL5-54	54"	120	14.0	17 lbs.	1853
HL5-60	60"	120	15.7	18 lbs.	1962
HL5-66	66"	120	17.3	19 lbs.	2071
HL5-72	72"	120	18.9	20 lbs.	2180



**HL5-36**  
Clear Anodized (standard)  
shown in top and  
underside views

### All Curved Display Light Models Feature:

Voltage: 120, single phase.

Models Shipped with: End panels, angle brackets with rocker switch underunit on power side.

Leads: 6" leads - on power side.

Dimensions: 18"-72"W x 6"D x 3"H (height includes standard angle bracket).

## OPTIONS (available at time of purchase only)

### Non-Adjustable Anodized Stands – Clear Anodized Standard

#### Side Mount Leg –

SNTL5-10T,-12T	Top mounting stand (specify 10" or 12" clearance)	\$241
SNTL5-14T,-16T	Top mounting stand (specify 14" or 16" clearance)	274
SNTL5-10B,-12B	Bottom mounting stand (specify 10" or 12" clearance)	241
SNTL5-14B,-16B	Bottom mounting stand (specify 14" or 16" clearance)	274

#### Bottom Mount Leg –

NTL5-10, -12	Tubular stands (specify 10" or 12" clearance)	1 pair	\$179
NTL5-14, -16	Tubular stands (specify 14" or 16" clearance)	1 pair	224
NTL5-PAINT	Designer color or Gloss Finish for Non-Adjustable Tubular Stands – Non-standard colors are non-returnable –	1 pair	50

### Designer Colors – Non-standard colors are non-returnable – Clear Anodized Standard –

RED	Warm Red	GRAY	Gray Granite	NAVY	Navy Blue	COPPER	Antique Copper	per foot	\$35
BLACK	Black	WHITE	White Granite	GREEN	Hunter Green				

### Gloss Finishes – Non-standard colors are non-returnable

GGOLD	Gleaming Gold	BBLACK	Bold Black	BBLUE	Brilliant Blue	GGRAY	Glossy Gray	per foot	\$48
RRED	Radiant Red								

### LED Leads (must specify LED Lead Length) –

HL5-LEAD5	5' total LED Lead Length (includes a 3' conduit)	\$40
HL5-LEAD6	6' total LED Lead Length (includes a 3' conduit)	51
HL5-LEAD7	7' total LED Lead Length (includes a 3' conduit)	62
HL5-LEAD8	8' total LED Lead Length (includes a 3' conduit)	73

HL5-LEAD9	9' total LED Lead Length (includes a 3' conduit)	\$84
HL5-LEAD10	10' total LED Lead Length (includes a 3' conduit)	95
HL5-CORD	6' Cord with Plug (NEMA 5-15P)	40

### LED Light –

HL5-3050	Warm White (3050K)	Standard
HL5-4100	Cool or Neutral White (4100K)	No Charge

**HL5-36 with SG5-36-CA**  
Sneeze Guard Accessory



## ACCESSORIES (available for purchase at any time)

### Curved tempered glass Sneeze Guard with penciled and polished edges for HL5 models – 24" D x 4 1/8" H

#### With Black Anodized Hardware –

SG5-18-BA	Sneeze Guard fits 18" HL5-18 model	\$572
SG5-24-BA	Sneeze Guard fits 24" HL5-24 model	583
SG5-30-BA	Sneeze Guard fits 30" HL5-30 model	600
SG5-36-BA	Sneeze Guard fits 36" HL5-36 model	622
SG5-42-BA	Sneeze Guard fits 42" HL5-42 model	688
SG5-48-BA	Sneeze Guard fits 48" HL5-48 model	715
SG5-54-BA	Sneeze Guard fits 54" HL5-54 model	732
SG5-60-BA	Sneeze Guard fits 60" HL5-60 model	781
SG5-66-BA	Sneeze Guard fits 66" HL5-66 model	798
SG5-72-BA	Sneeze Guard fits 72" HL5-72 model	814

#### With Clear Anodized Hardware –

SG5-18-CA	Sneeze Guard fits 18" HL5-18 model	\$572
SG5-24-CA	Sneeze Guard fits 24" HL5-24 model	583
SG5-30-CA	Sneeze Guard fits 30" HL5-30 model	600
SG5-36-CA	Sneeze Guard fits 36" HL5-36 model	622
SG5-42-CA	Sneeze Guard fits 42" HL5-42 model	688
SG5-48-CA	Sneeze Guard fits 48" HL5-48 model	715
SG5-54-CA	Sneeze Guard fits 54" HL5-54 model	732
SG5-60-CA	Sneeze Guard fits 60" HL5-60 model	781
SG5-66-CA	Sneeze Guard fits 66" HL5-66 model	798
SG5-72-CA	Sneeze Guard fits 72" HL5-72 model	814

HL5 - x x

Glo-Rite Curved Display Light Aluminum Housing Width (Inches)

## COLORS AND FINISHES – INSIDE BACK COVER



## Glo-Rite® Display Lights

Let the light shine on your work surface or display areas with the Glo-Rite® Display Lights. Durable and effective, Hatco light strips are made of extruded aluminum housings with bright-annealed reflectors for maximum brightness.

- Incandescent bulbs with special protective coating to guard against food contamination
- Extra lamps available on models from 24" to 72"
- Optional *Designer* colors: Warm Red, Black, Gray Granite, White Granite, Navy Blue, Hunter Green, Antique Copper



HL-24-2 including extra lamp assembly with lamps on 12" centers standard

### GLO-RITE DISPLAY LIGHTS

Decorative Lamps & Display Lights

Model	Voltage Single Phase	No. of Bulbs	Width	Watts <sup>▲</sup>	Approx. Ship Weight	List Price
HL-18	120	2	18"	120	6 lbs.	\$ 430
HL-24	120	2	24"	120	7 lbs.	455
HL-24-2	120	3	24"	180	6 lbs.	515
HL-30	120	2	30"	120	7 lbs.	480
HL-30-2	120	4	30"	240	8 lbs.	570
HL-36	120	3	36"	180	8 lbs.	548
HL-36-2	120	5	36"	300	9 lbs.	648
HL-42	120	3	42"	180	10 lbs.	572
HL-42-2	120	6	42"	360	10 lbs.	702
HL-48	120	4	48"	240	11 lbs.	640
HL-48-2	120	7	48"	420	12 lbs.	780
HL-54	120	4	54"	240	12 lbs.	665
HL-54-2	120	8	54"	480	13 lbs.	834
HL-60	120	5	60"	300	13 lbs.	733
HL-60-2	120	9	60"	540	13 lbs.	912
HL-66	120	5	66"	300	14 lbs.	820
HL-66-2	120	10	66"	600	15 lbs.	1020
HL-72	120	6	72"	360	18 lbs.	906
HL-72-2	120	10	72"	600	22 lbs.	1119

▲ Rated at 60 watt but comes with 40 watt incandescent bulb.

#### All Display Light Models Feature:

Toggle Switch (max. 15 amps) Location: Chef's left side (unless otherwise specified).

Leads: 6" leads – server's right.

Dimensions: 3"D x 2½"H.

#### OPTIONS (available at time of purchase only)

HAL	60 watt Halogen Bulb in lieu of standard Display Light	each \$69
NO BULB	No Bulb	No Charge
REM TOG	Remote Toggle Switch (max. 15 amps)	No Charge
<b>Leads (must specify Lead Length) –</b>		
LEADS5	1'-5' Extended Electrical Leads	\$ 29
LEADS10	6'-10' Extended Electrical Leads	58
LEADS15	11'-15' Extended Electrical Leads	87
LEADS20	16'-20' Extended Electrical Leads	116

#### ACCESSORIES (available for purchase at any time)

HL-BRKT	Adjustable Angle Bracket	pair \$ 33
<b>Chef Bulbs (120V) adjustable bulb – Bulbs must be rotated down –</b>		
CLED-3000-120	Chef LED Bulb (similar to warm Halogen light)	each 139
CLED-4000-120	Chef LED Bulb (similar to cool Fluorescent light)	each 139

#### OPTIONS (available at time of purchase only)

**Designer Colors – Non-standard colors are non-returnable –**

RED	Warm Red	per foot \$35
BLACK	Black	per foot 35
GRAY	Gray Granite	per foot 35
WHITE	White Granite	per foot 35
NAVY	Navy Blue	per foot 35
GREEN	Hunter Green	per foot 35
COPPER	Antique Copper	per foot 35

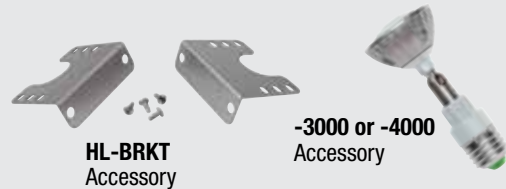

HL-BRKT Accessory

-3000 or -4000 Accessory

#### COLORS AND FINISHES – INSIDE BACK COVER

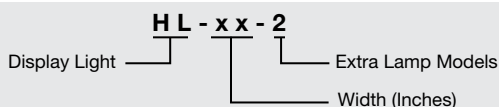

# Hatco® Flav-R-Shield® Sneeze Guards



People who serve, products that solve.®



Double-Sided Self-Service Sneeze Guard Model **ES92** with **GR5AHL** Strip Heaters

Not only can you design the perfect sneeze guard to meet your needs (via our online configurator), but you can also integrate one of Hatco's signature strip heater or lights to showcase your offering.

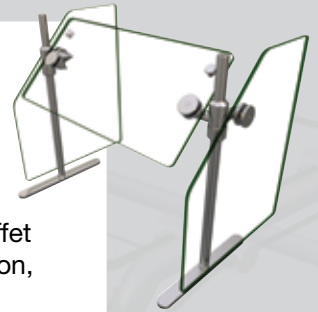

Portable Sneeze Guard Model **ORBIT720** with accessory end panels

## A clear win for safety

Protect food without affecting visibility

With Hatco® quality and innovation, safeguarding food items is easier than ever. Ideal for buffet lines, serving stations or events, our Flav-R-Shield® Sneeze Guards bring maximum protection, visibility, functionality and style to any foodservice operation. With full-service, portable and self-service models to choose from, we make it easy to create the perfect sneeze guard option for your needs. Plus, with a quick turnaround from order to shipping, you're ensured Hatco dependability on a timeline that works for you.

**Discover the innovation that fuels our products and drives your success.**

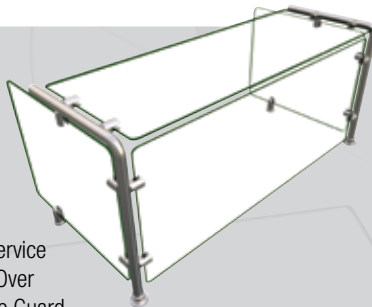

Full-Service Pass-Over Sneeze Guard Model **EP11**



Portable Adjustable Sneeze Guard Model **ALLIN1**



Full-Service Sneeze Guard Model **EP5**

## Configure it!

Hatco has made it a snap to create a customized Sneeze Guard to your exact specifications, with one of the most powerful online configurators to date. Once you arrive at the Hatco Sneeze Guard website (scan QR code to the right or use this URL: [www.hatcosneezeguards.com](http://www.hatcosneezeguards.com)), please click on your choice:

- Full-Service
- Self-Serve
- Barrier
- Portable
- Convertible
- ORBIT

...and click on Quotation. You'll be directed to the configurator for that product.

**Configure your Hatco Flav-R-Shield® Sneeze Guard today!**



**Sneeze Guard  
CONFIGURE IT!**  
Hardware, glass,  
lighting & more!  
[hatcosneezeguards.com](http://hatcosneezeguards.com)

# Strip Heaters

*Cafeterias • Buffets • Supermarkets & Delis  
Restaurants & Cafés • Clubs & Bars*



**GR5AL-60** in optional Radiant Red Gloss Finish above a **GRSB-54-I** (Sneeze Guard not available) *pg. 75*



**GRAL-48** *pg. 78*



**GRAH-42D** with optional 6" spacer and optional non-adjustable tubular stands *pg. 80*



**GRAML-60D** with optional non-adjustable tubular stands *pg. 86*



**GRNH-48** with standard Angle brackets and optional *Designer Warm Red* (Sneeze Guards as shown not available) *pg. 88*



**GRAIHL-48**, requires Remote Control Enclosure (RMB) *pg. 90*



**GR2AHL-84** with optional *Designer Black* housing and Sneeze Guards *pg. 94*



**UGA-24D** in optional Radiant Red Gloss Finish *pg. 99*



**UGAH-36D** with Standard 3" spacer *pg. 99*



**Ordering Instructions – Watch How To Order A Hatco Strip Heater on Hatco's website under Resources, Video Library**

**QUICK GUIDE – SOLUTIONS FOR ANY CLEARANCE – Detailed mounting and spacing requirements found on page 101**

**NARROW CLEARANCE**

**Infra-Black®**

- Provides a very even and thermostatically controlled heat source
- For applications where the distance from the heat source to the target is narrow

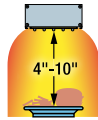

**STANDARD CLEARANCE**

**Infrared Metal Sheathed Element:**

- Pre-focused heat pattern directs infrared heat to the holding area
- Uniform heat distribution
- Energy efficient
- A wide variety of sizes and features available
- Our most popular solution

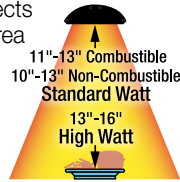

**HIGH CLEARANCE**

**Ultra-Glo® Durable Ceramic Element**

- Stronger, more intense heat source
- For applications where there is a greater distance between the heat source and target surface
- Ideal for French fry station applications

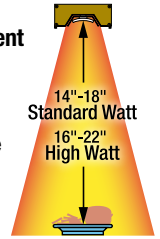

**GR5AL-36 or GR5AHL-36**



**GR5A-36 or GR5AH-36**

**Glo-Ray® Curved Infrared Strip Heaters: (pages 74-76)**

1. Choose a length
2. Standard or high watt
3. Lights or no lights
4. Voltage: 120, 208, 240
5. Choose control option for GR5A and GR5AH \*\* (GR5AL, GR5AHL have Remote Control Enclosure included)



**GRA-72, GRAH-72 or GRAM-72**



**GRA-72D, GRAH-72D or GRAM-72D**



**GRAL-72, GRAHL-72 or GRAML-72**



**GRAL-72D, GRAHL-72D or GRAML-72D**

**Glo-Ray® Infrared Metal-Sheathed Strip Heaters: (pages 77-87)**

1. Choose a length
2. Single or dual warmer
3. Standard, high or max watt
4. Lights or no lights
5. Voltage: 120, 208, 240 without lights or 120, 240, 120/208, 120/240 for units with lights
6. Choose control option, remote installation recommended (required on some models)\*\*

**GR-36 or GRH-36**



**Glo-Ray® Infrared Stainless Steel Strip Heaters: (pages 78-79)**

1. Choose a length
2. Standard or high watt
3. Voltage: 120, 208 or 240
4. Choose control option, remote installation is recommended\*\*

**GRN-24, GRNH-24 or GRNM-24**



**Glo-Ray® Narrow Infrared Strip Heaters: (page 88-89)**

1. Choose a length
2. Standard, high or max watt
3. Voltage: 120, 208, 240
4. Choose control option, remote installation is recommended\*\*

\*\*Multiple Strip Heaters may be connected to one RMB2 if the combined Amp draw of the warmers are less than the rating for the RMB2.



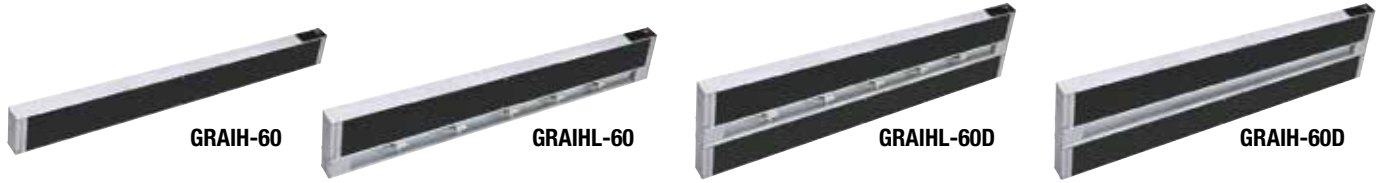

**Glo-Ray® Infra-Black® Strip Heaters:** (pages 90-92)

1. Choose a length
2. Single or dual warmer
3. Lights or no lights
4. Voltage: 120, 208, 240 without lights or 120/208, 120/240 for units with lights
5. Choose control option, remote installation is recommended<sup>∞</sup>



**Glo-Ray® Designer Infrared Strip Heaters:** (pages 93-97)

1. Choose a length
2. Single or dual warmer
3. Standard or high watt
4. Lights or no lights
5. Voltage: 120, 208, 240 without lights or 120/208, 120/240 for units with lights
6. Choose control option, remote installation only<sup>∞</sup>
7. Choose inset panel and corner cap color
8. Select Non-adjustable Stand Length or optional Overhead Mount (shown)



**Ultra-Glo® Ceramic Strip Heaters:** (pages 98-100)

1. Choose a length
2. Single or dual warmer
3. Standard or high watt
4. Lights or no lights
5. Voltage: 120, 208, 240 without lights or 120/208, 120/240 for units with lights
6. Choose control option, remote installation is recommended<sup>∞</sup>

<sup>∞</sup>Multiple Strip Heaters may be connected to one RMB2 if the combined Amp draw of the warmers are less than the rating for the RMB2.

Strip Heaters

**Power and Switch Location**

Each Strip Heater has specific Power and Switch locations (sample below). For information on other models, visit the *Document Library* under *Resources* on [hatcocorp.com](http://hatcocorp.com), and search *Power Locations*.

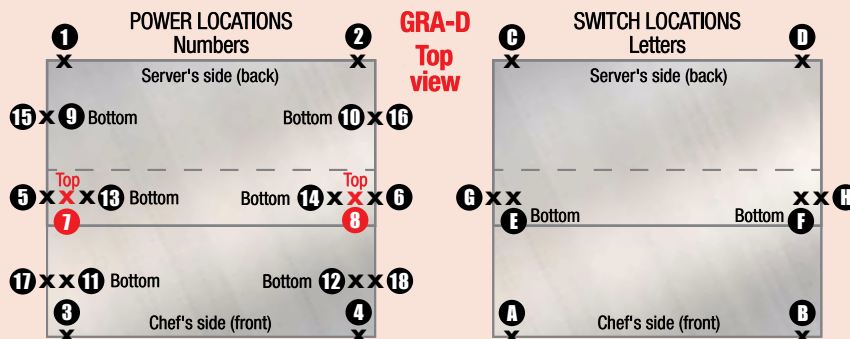

**POWER:** Numbers indicate potential power locations. Locations 9, 10, 11 and 12 are on the bottom of the warmer and are intended to be used in conjunction with the optional legs supplied by Hatco. Note: Maximum of 3 circuits down the leg. **SWITCH:** Letters indicate the potential control locations.

**NOTE:** Remote controls are available and recommended.

**Typical Conduit Connection**

**Glo-Ray® Strip Heaters** come standard with right angle attached 3' conduit and 42" leads on back of unit.

**Narrow Strip Heaters** have standard 6" leads, no conduit.

**GR2A** models - conduit exits non-adjustable stand or overhead mount only. **GR5AL** models have a 5' leadwire, which is 2' past the 3' conduit.

**Ultra Glo®** models - conduit exits through attached control box; if no control box, conduit exits side of unit.



## Glo-Ray® Curved Infrared Strip Heaters

This stylish, patented design, based on our signature Glo-Ray Strip Heaters, is the perfect solution for your front-of-the-house applications. Superb for buffet and serving lines, the sleek curved design minimizes its size while accenting and warming the products below.

The entire holding surface is heated evenly with no “cold” spots thanks to Hatco's dependable infrared element technology.

- Narrow, curved design: 2"H x 6"D uses a very small footprint
- Lengths available from 18"-72" in 6" increments
- Patented housing design
- Angle brackets (mounting) are standard

- Pre-focused heat maintains safe serving temperatures longer without continuing to cook the food
- Available in standard or high watt
- End panels and mounting brackets match unit color
- Hatco's wide array of colors help provide the right look for your venue



**GR5A-36/GR5AH-36** with new accessory Sneeze Guard (with Clear Anodized hardware), in optional Glossy Gray Gloss Finish with optional 16" non-adjustable tubular stands (legs) in optional Glossy Gray Finish

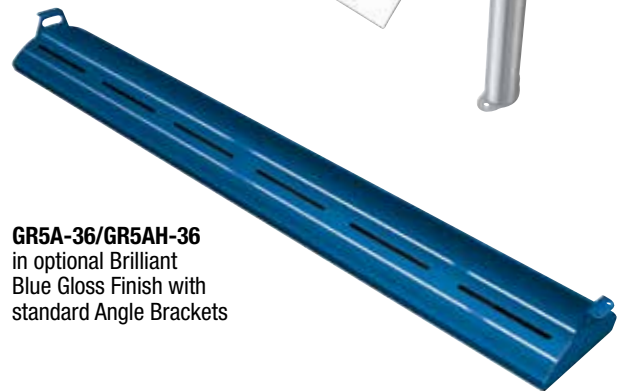

**GR5A-36/GR5AH-36** in optional Brilliant Blue Gloss Finish with standard Angle Brackets

### GLO-RAY CURVED INFRARED STRIP HEATERS

Model	Width	Voltage Single Phase	Watts	Approx. Ship Weight	List Price <sup>o</sup>
<b>Standard Watt</b>					
GR5A-18	18"	120, 208 or 240	250	10 lbs.	\$ 781
GR5A-24	24"	120, 208 or 240	350	11 lbs.	836
GR5A-30	30"	120, 208 or 240	450	12 lbs.	891
GR5A-36	36"	120, 208 or 240	575	12 lbs.	946
GR5A-42	42"	120, 208 or 240	675	13 lbs.	1001
GR5A-48	48"	120, 208 or 240	800	15 lbs.	1056
GR5A-54	54"	120, 208 or 240	925	17 lbs.	1111
GR5A-60	60"	120, 208 or 240	1050	20 lbs.	1166
GR5A-66	66"	120, 208 or 240	1160	25 lbs.	1221
GR5A-72	72"	120, 208 or 240	1275	25 lbs.	1276
<b>High Watt</b>					
GR5AH-18	18"	120, 208 or 240	350	10 lbs.	\$ 789
GR5AH-24	24"	120, 208 or 240	500	11 lbs.	844
GR5AH-30	30"	120, 208 or 240	660	12 lbs.	899
GR5AH-36	36"	120, 208 or 240	800	12 lbs.	954
GR5AH-42	42"	120, 208 or 240	950	13 lbs.	1009
GR5AH-48	48"	120, 208 or 240	1100	15 lbs.	1064
GR5AH-54	54"	120, 208 or 240	1250	17 lbs.	1119
GR5AH-60	60"	120, 208 or 240	1400	20 lbs.	1174
GR5AH-66	66"	120, 208 or 240	1560	25 lbs.	1229
GR5AH-72	72"	120, 208 or 240	1725	25 lbs.	1284

<sup>o</sup> Does not include Remote Control Enclosure (RMB), see pages 76, 103 and 104.

! Infinite switch not available on 120V.

#### All Glo-Ray Curved Infrared Models Feature:

Leads: 3' conduit, 5' Power Leads.

Angle Brackets: Provides 1" clearance between Strip Heater and overshef.

Dimensions: 18"-72"W x 6"D x 2"H.

#### OPTIONS AND ACCESSORIES – PAGE 76

#### RECOMMENDED MOUNTING HEIGHTS – PAGE 101

#### COLORS AND FINISHES – INSIDE BACK COVER

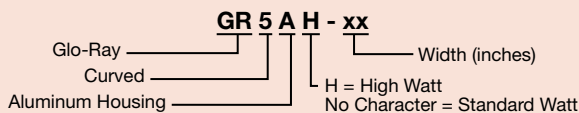

## Glo-Ray® Curved Infrared Strip Heaters with LED Lights

Hatco's Glo-Ray Curved Infrared Strip Heaters with LED Lights feature a patented housing design that is low-profile, elliptical-shaped and stylish, the ideal solution for front-of-the-house applications where heat and/or lights are needed.

It can operate with just the dual LED lights; or the dual LED lights can be used simultaneously with the infrared emitter to provide the perfect balance of light and heat.

- Narrow, curved design: 2"H x 6"D uses a very small footprint with lengths available from 18"-72" in 6" increments
- Patented housing design has energy efficient dual LED lights across the entire strip heater, which provide longer performance and energy savings (compared to standard incandescent bulbs - 3.5 to 15.2 watts based on length)
- Angle brackets (mounting) are standard
- Pre-focused heat maintains safe serving temperatures longer without continuing to cook the food
- Can be used with lights only or heat only
- 100% linear infinite controls with adjustability from 0-100%, allow for precise settings
- Field replaceable LED available as:
  - Warm White\* (standard)
  - Neutral (Cool) White\*
  - Dual Color: Warm White/Neutral (Cool) White\* (toggle between color temperatures to enhance foods displayed)
- Electronic Infinite Control Remote Box and power On/Off switch (controls lights, heat) included
- Available as lights only (see HL5 series in Decorative Lamps & Display Lights section)



**GR5AL-36/GR5AHL-36**  
Top and bottom view. Shown in optional Radiant Red Gloss Finish and standard Angle Brackets



### GLO-RAY CURVED INFRARED STRIP HEATERS with LED LIGHTS

Model	Width	Voltage Single Phase	Watts	Approx. Ship Weight	List Price
<b>Standard Watt</b>					
GR5AL-18	18"	120, 208 or 240	254	16 lbs.	\$2592
GR5AL-24	24"	120, 208 or 240	356	18 lbs.	2740
GR5AL-30	30"	120, 208 or 240	458	21 lbs.	2888
GR5AL-36	36"	120, 208 or 240	584	21 lbs.	3036
GR5AL-42	42"	120, 208 or 240	686	24 lbs.	3184
GR5AL-48	48"	120, 208 or 240	812	24 lbs.	3332
GR5AL-54	54"	120, 208 or 240	939	27 lbs.	3480
GR5AL-60	60"	120, 208 or 240	1066	28 lbs.	3628
GR5AL-66	66"	120, 208 or 240	1177	29 lbs.	3776
GR5AL-72	72"	120, 208 or 240	1294	30 lbs.	3924
<b>High Watt</b>					
GR5AHL-18	18"	120, 208 or 240	354	16 lbs.	\$2600
GR5AHL-24	24"	120, 208 or 240	506	17 lbs.	2748
GR5AHL-30	30"	120, 208 or 240	668	21 lbs.	2896
GR5AHL-36	36"	120, 208 or 240	809	21 lbs.	3044
GR5AHL-42	42"	120, 208 or 240	961	22 lbs.	3192
GR5AHL-48	48"	120, 208 or 240	1112	25 lbs.	3340
GR5AHL-54	54"	120, 208 or 240	1264	25 lbs.	3488
GR5AHL-60	60"	120, 208 or 240	1416	29 lbs.	3636
GR5AHL-66	66"	120, 208 or 240	1577	29 lbs.	3784
GR5AHL-72	72"	120, 208 or 240	1744	30 lbs.	3932

**All Glo-Ray Curved Infrared Models with Lights Feature:**

**Switch Location:** Remote box with electronic infinite control and power On/Off switch (controls lights and heat) included.  
**Leads:** 3' conduit, 5' Power Leads, 6½' (78") LED Leads. standard LED lead length is 1½' (18") longer than Power Lead length.  
**Angle Brackets:** Provides 1" clearance between strip heater and overself.  
**Dimensions:** 18"-72"W x 6"D x 2"H. **Control Box Dimensions:** 11"W x 5½"H.  
**Cut Out Dim.:** 10⅞"W x 6¼"D x 4¾"H.

**OPTIONS AND ACCESSORIES – PAGE 76**

**RECOMMENDED MOUNTING HEIGHTS – PAGE 101**

**COLORS AND FINISHES – INSIDE BACK COVER**

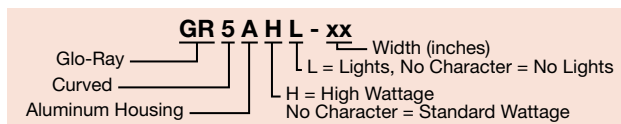

Optional Sneeze Guard with black Anodized hardware

Strip Heaters

**RECOMMENDED LIGHT USAGE**

GR5A(H)L above...	Warm White*	Cool White*	Warm/Neutral (Cool) White*
Heated Well(s)	X		
Refrigerated Well(s)		X	
Heated Shelf (Shelves)	X		
Refrigerated Shelf (Shelves)		X	
Hot/Cold Well(s)			X
Hot/ Cold Shelf (Shelves)			X

\* Warm White can range from 2700-3200K, Neutral (Cool) White from 4000-4300K

**OPTIONS** (available at time of purchase only)

**Designer Colors – End panels and Angle Brackets match unit color – Non-standard colors are non-returnable –** per foot \$35

<b>RED</b> Warm Red	<b>BLACK</b> Black	<b>GRAY</b> Gray Granite	<b>COPPER</b> Antique Copper
---------------------	--------------------	--------------------------	------------------------------

**Gloss Finishes – End panels and Angle Brackets match unit color – Non-standard colors are non-returnable –** per foot \$48

<b>GGOLD</b> Gleaming Gold	<b>BBLUE</b> Brilliant Blue	<b>GGRAY</b> Glossy Gray
----------------------------	-----------------------------	--------------------------

<b>RRED</b> Radiant Red	<b>BBLACK</b> Bold Black
-------------------------	--------------------------

**Non-Adjustable Tubular Stands – Clear Anodized standard –**

**Bottom mount leg for bottom mount installation**

<b>NTL5-10, -12</b> Specify 10" or 12" clearance	<b>1 pair \$179</b>
--	---------------------

<b>NTL5-14, -16</b> Specify 14" or 16" clearance	<b>1 pair 224</b>
--	-------------------

**Side mount leg for bottom mount installation**

<b>SNTL5-10B, -12B</b> Specify 10" or 12" clearance	<b>1 pair \$241</b>
---	---------------------

<b>SNTL5-14B, -16B</b> Specify 14" or 16" clearance	<b>1 pair 274</b>
---	-------------------

**Side mount leg for top mount installation**

<b>SNTL5-10T, -12T</b> Specify 10" or 12" clearance	<b>1 pair \$241</b>
---	---------------------

<b>SNTL5-14T, -16T</b> Specify 14" or 16" clearance	<b>1 pair 274</b>
---	-------------------

**NTL5-PAINT Designer Color or Gloss Finish for Non-Adjustable Tubular Stands – Non-standard colors are non-returnable –** per foot \$50

<b>RED</b> Warm Red	<b>GRAY</b> Gray Granite	<b>NAVY</b> Navy Blue	<b>COPPER</b> Antique Copper
---------------------	--------------------------	-----------------------	------------------------------

<b>BLACK</b> Black	<b>WHITE</b> White Granite	<b>GREEN</b> Hunter Green
--------------------	----------------------------	---------------------------

<b>RRED</b> Radiant Red	<b>GGRAY</b> Glossy Gray	<b>BBLACK</b> Bold Black
-------------------------	--------------------------	--------------------------

<b>GGOLD</b> Gleaming Gold	<b>BBLUE</b> Brilliant Blue
----------------------------	-----------------------------

**GR5AL-NW** Neutral (Cool) White LED – Neutral (Cool) White can range from 4000-4300K **No Charge**

**GR5AL-WW/NW** Dual Warm/Neutral (Cool) White LED – Warm White can range from 2700-3200K, Neutral (Cool) White from 4000-4300K **\$369**

**GR5AL-OPP** Power and LED wiring exit opposite ends of unit (Same end is the standard offering) – Must specify Power Lead length and LED Lead length required – **No Charge**

**Power Wire Leads – GR5A(H) models– 5' Power Lead length standard –**

<b>GR5A-LEADS10</b> 6'-10' total Power Lead length	<b>\$29</b>
--	-------------

<b>GR5A-LEADS15</b> 11'-15' total Power Lead length	<b>58</b>
---	-----------

**Power Wire Leads – GR5A(H)L models– 5' Power Lead length standard –**

<b>GR5AL-LEADS10</b> 6'-10' total power Lead length	<b>\$29</b>
---	-------------

<b>GR5AL-LEADS15</b> 11'-15' total power Lead length	<b>58</b>
--	-----------

**LED Leads - 6½' (78") LED Lead length standard – Standard LED lead length is 1½' (18") longer than Power Lead length**

<b>LED-LEADS10</b> 11½' (138") total LED Lead length	<b>\$ 45</b>
--	--------------

<b>LED-LEADS15</b> 16½' (198") total LED Lead length	<b>90</b>
--	-----------

<b>LED-LEADS20</b> 21½' (258") total LED Lead length	<b>135</b>
--	------------

**NO CONTROL** GR5A(H) models only – No control included, requires selection of RMB2-xx control – page 103 **No Charge**

**REM INF** GR5A(H) models only – Remote Infinite Switches in lieu of Toggle (max. 12.2 Amps) – **\$ 51**

**REM TOG** GR5A(H) models only – Remote Toggle Switches (max. 15 Amps) – **No Charge**

**RMB** GR5A(H) models only – Remote Box – Available in Designer Colors or Gloss Finishes – see page 104

**RMB5-2R** Remote Box for GR5A(H)L models – Allows for up to two 72" wide units to be connected to a single control box at same set points – 14"W x 5<sup>15</sup>/<sub>16</sub>"D x 5<sup>1</sup>/<sub>2</sub>"H (Cut out dimensions: 13<sup>1</sup>/<sub>8</sub>"W x 4<sup>3</sup>/<sub>4</sub>"H) **\$1254**

Strip Heaters



**ACCESSORIES** (available for purchase at any time)

**Curved tempered glass Sneeze Guard with penciled, polished edges for GR5A(H), GR5A(H)L models only – 24" D x 4 1/8" H**

With Black Anodized hardware		With Clear Anodized hardware	
<b>SG5-18-BA</b> Sneeze Guard fits GR5A(H)(L)-18 models	<b>\$572</b>	<b>SG5-18-CA</b> Sneeze Guard fits GR5A(H)(L)-18 models	<b>\$572</b>
<b>SG5-24-BA</b> Sneeze Guard fits GR5A(H)(L)-24 models	<b>583</b>	<b>SG5-24-CA</b> Sneeze Guard fits GR5A(H)(L)-24 models	<b>583</b>
<b>SG5-30-BA</b> Sneeze Guard fits GR5A(H)(L)-30 models	<b>600</b>	<b>SG5-30-CA</b> Sneeze Guard fits GR5A(H)(L)-30 models	<b>600</b>
<b>SG5-36-BA</b> Sneeze Guard fits GR5A(H)(L)-36 models	<b>622</b>	<b>SG5-36-CA</b> Sneeze Guard fits GR5A(H)(L)-36 models	<b>622</b>
<b>SG5-42-BA</b> Sneeze Guard fits GR5A(H)(L)-42 models	<b>688</b>	<b>SG5-42-CA</b> Sneeze Guard fits GR5A(H)(L)-42 models	<b>688</b>
<b>SG5-48-BA</b> Sneeze Guard fits GR5A(H)(L)-48 models	<b>715</b>	<b>SG5-48-CA</b> Sneeze Guard fits GR5A(H)(L)-48 models	<b>715</b>
<b>SG5-54-BA</b> Sneeze Guard fits GR5A(H)(L)-54 models	<b>732</b>	<b>SG5-54-CA</b> Sneeze Guard fits GR5A(H)(L)-54 models	<b>732</b>
<b>SG5-60-BA</b> Sneeze Guard fits GR5A(H)(L)-60 models	<b>781</b>	<b>SG5-60-CA</b> Sneeze Guard fits GR5A(H)(L)-60 models	<b>781</b>
<b>SG5-66-BA</b> Sneeze Guard fits GR5A(H)(L)-66 models	<b>798</b>	<b>SG5-66-CA</b> Sneeze Guard fits GR5A(H)(L)-66 models	<b>798</b>
<b>SG5-72-BA</b> Sneeze Guard fits GR5A(H)(L)-72 models	<b>814</b>	<b>SG5-72-CA</b> Sneeze Guard fits GR5A(H)(L)-72 models	<b>814</b>



RMB5-2R



SG5-BA (black anodized hardware)

**RECOMMENDED MOUNTING HEIGHTS – PAGE 101**  
**COLORS AND FINISHES – INSIDE BACK COVER**



## Glo-Ray® Aluminium Infrared Strip Heaters

Safely hold the temperature of your product without drying out or further cooking food with these Strip Heaters. The end result is hot, fresh food that's ready-to-serve. The continuous aluminum housing and heavy-duty mountings ensure the durability and quality of Hatco products. Heavy-duty Stainless Steel housings are available (next page).

- Ensures maximum flavor, safety and holding time
- Even heat distribution – no “cold spots”
- Sturdy extruded aluminum housings that do not sag, from 18" to 144" (12')
- Reflector does not blacken, maintaining a consistent heat pattern
- Heavy-duty insulation minimizes heat loss
- Optional Sneeze Guards (excludes Stainless Steel models)
- Available in Stainless Steel housing 18" to 96"
- Available with lights (shatter resistant incandescent lights or optional halogen lights - excludes Stainless Steel models)

- Pre-focused heat pattern bathes entire holding surface
- Additional reflector styles and lower wattage elements available, consult factory for more information



**GRAH-36** High watt, toggle controlled with 2-S hooks and 2-6" chains accessory (optional cord and plug attached)

**Toggle Switch:** Max. 15 Amps  
**Infinite Switch:** Max. 12.2 Amps

### ALUMINUM STRIP HEATERS with CONDUIT (Standard Watt)

Model	Width	Voltage Single Phase	Watts	Approx. Ship Weight	List Price <sup>o</sup>
<b>Standard Watt</b>					
GRA-18	18"	120, 208 or 240	250	7 lbs.	\$ 351
GRA-24	24"	120, 208 or 240	350	7 lbs.	369
GRA-30	30"	120, 208 or 240	450	8 lbs.	395
GRA-36	36"	120, 208 or 240	575	9 lbs.	420
GRA-42	42"	120, 208 or 240	675	10 lbs.	446
GRA-48	48"	120, 208 or 240	800	11 lbs.	474
GRA-54	54"	120, 208 or 240	925	13 lbs.	504
GRA-60	60"	120, 208 or 240	1050	14 lbs.	538
GRA-66	66"	120, 208 or 240	1160	16 lbs.	592
GRA-72	72"	120, 208 or 240	1275	17 lbs.	669
GRA-84	84"	120, 208 or 240	1500	19 lbs.	773
GRA-96	96"	120, 208 or 240	1725	21 lbs.	880
GRA-108↔	108"	120, 208 or 240	1850	24 lbs.	1110
GRA-120↔	120"	120, 208 or 240	2100	26 lbs.	1206
GRA-132↔	132"	120, 208 or 240	2320	30 lbs.	1304
GRA-144↔	144"	120, 208 or 240	2550	33 lbs.	1400

<sup>o</sup> Does not include Remote Control Enclosure (RMB), see pages 103 and 104.  
 / When using an infinite control with 120 volt model, additional switch(es) and tandem (end-to-end) elements are required, cord not available.  
 ✗ 120 volt models require additional switches and tandem (end-to-end) elements.  
 ↔ Models 108" and longer are tandem.

#### All Glo-Ray Aluminum Infrared Models Feature:

**Toggle Switch (max. 15 Amps) Location:** Chef's left side (unless otherwise specified).  
**Leads:** 3' conduit with leads – server's right. NEMA 5-15P cord available on 120 volt models 72" or less with C-leg, T-leg stand or chain-hook mount. GRAH-66 and GRAH-72 require NEMA 5-20P cord for Canada.  
**Dimensions:** 18"-144"W x 6"D x 2½"H.

**OPTIONS AND ACCESSORIES – PAGE 79**  
**RECOMMENDED MOUNTING HEIGHTS – PAGE 101**

### ALUMINUM STRIP HEATERS with CONDUIT (High Watt)

Model	Width	Voltage Single Phase	Watts	Approx. Ship Weight	List Price <sup>o</sup>
<b>High Watt</b>					
GRAH-18	18"	120, 208 or 240	350	7 lbs.	\$ 359
GRAH-24	24"	120, 208 or 240	500	8 lbs.	377
GRAH-30	30"	120, 208 or 240	660	8 lbs.	403
GRAH-36	36"	120, 208 or 240	800	9 lbs.	428
GRAH-42	42"	120, 208 or 240	950	11 lbs.	454
GRAH-48	48"	120, 208 or 240	1100	11 lbs.	482
GRAH-54	54"	120, 208 or 240	1250	13 lbs.	512
GRAH-60	60"	120, 208 or 240	1400	14 lbs.	546
GRAH-66	66"	120, 208 or 240	1560	16 lbs.	600
GRAH-72	72"	120, 208 or 240	1725	17 lbs.	677
GRAH-84	84"	120, 208 or 240	2050	19 lbs.	781
GRAH-96	96"	120, 208 or 240	2400	21 lbs.	888
GRAH-108↔	108"	120, 208 or 240	2500	23 lbs.	1118
GRAH-120↔	120"	120, 208 or 240	2800	26 lbs.	1214
GRAH-132↔	132"	120, 208 or 240	3120	31 lbs.	1312
GRAH-144↔	144"	120, 208 or 240	3450	48 lbs.	1408

### ALUMINUM STRIP HEATERS with S HOOKS, CHAINS and CORD and PLUG ATTACHED



Model	Item No.	Width	Voltage Single Phase	Watts	Approx. Ship Weight	List Price
<b>Standard Watt - Toggle Controlled with S Hooks and Chain, Cord and Plug attached</b>						
GRA-24	GRA24120TCCS	24"	120	350	7 lbs.	\$424
GRA-36	GRA36120TCCS	36"	120	575	9 lbs.	475
GRA-48	GRA48120TCCS	48"	120	800	11 lbs.	529
GRA-60	GRA60120TCCS	60"	120	1050	14 lbs.	593
<b>High Watt - Toggle Controlled with S Hooks and Chain, Cord and Plug attached</b>						
GRAH-18	AH18120TCCS	18"	120	350	6 lbs.	\$414
GRAH-24	AH24120TCCS	24"	120	500	7 lbs.	432
GRAH-30	AH30120TCCS	30"	120	660	8 lbs.	458
GRAH-36	AH36120TCCS	36"	120	800	9 lbs.	483
GRAH-42	AH42120TCCS	42"	120	950	10 lbs.	509
GRAH-48	AH48120TCCS	48"	120	1100	11 lbs.	537
GRAH-60	AH60120TCCS	60"	120	1400	14 lbs.	601
GRAH-72*	AH72120TCCS.1	72"	120	1725	17 lbs.	732
<b>High Watt - Infinite Controlled with S Hooks and Chain, Cord and Plug attached</b>						
GRAH-24	AH24120ICCS	24"	120	500	7 lbs.	\$483
GRAH-36	AH36120ICCS	36"	120	800	9 lbs.	534
GRAH-48	AH48120ICCS	48"	120	1100	11 lbs.	588
GRAH-60	AH60120ICCS	60"	120	1400	14 lbs.	652

\* Not available for Canada

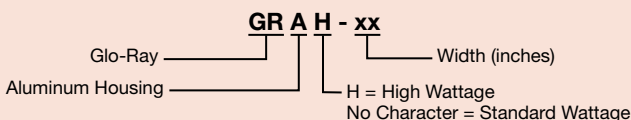



**GRAHL-36** with optional Sneeze Guards and adjustable tubular stands

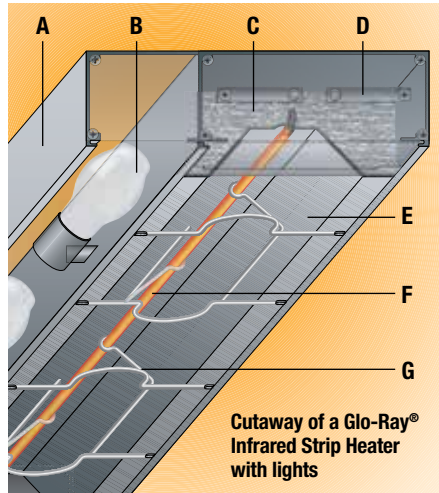

**Cutaway of a Glo-Ray® Infrared Strip Heater with lights**

- A** Stainless Steel or sturdy aluminum housings that do not sag, from 18" up to 144" (12" in 6" increments). Stainless Steel units available as single units without lights, up to 96" in width
- B** Shatter-resistant incandescent lights (standard on GRAL/GRAHL), optional halogen bulb available
- C** Heavy-duty insulation minimizes heat loss
- D** Standard Hanger Tabs are provided
- E** Aluminized reflector retains full heat intensity and directs more heat towards the edges of the holding surface
- F** Metal-sheathed heating element part guaranteed against burnout and breakage for two years
- G** Protective wire guard supports heating element without affecting heat distribution

**ALUMINUM STRIP HEATERS with LIGHTS with CONDUIT**

**STAINLESS STEEL STRIP HEATERS with CONDUIT**

Strip Heaters

Model	Bulbs	Width	Voltage Single Phase	Watts	Approx. Ship Weight	List Price <sup>o</sup>
<b>Standard Watt</b>						
GRAL-18	2	18"	120, 120/208 or 120/240	370	9 lbs.	\$ 558
GRAL-24	2	24"	120, 120/208 or 120/240	470	10 lbs.	581
GRAL-30	2	30"	120, 120/208 or 120/240	570	12 lbs.	646
GRAL-36	3	36"	120, 120/208 or 120/240	755	13 lbs.	712
GRAL-42	3	42"	120, 120/208 or 120/240	855	15 lbs.	781
GRAL-48	4	48"	120, 120/208 or 120/240	1040	17 lbs.	849
GRAL-54	4	54"	120, 120/208 or 120/240	1165	19 lbs.	927
GRAL-60	5	60"	120, 120/208 or 120/240	1350	21 lbs.	1008
GRAL-66	5	66"	120, 120/208 or 120/240	1460	22 lbs.	1103
GRAL-72	6	72"	120, 120/208 or 120/240	1635	24 lbs.	1229
GRAL-84'	7	84"	120, 120/208 or 120/240	1920	28 lbs.	1420
GRAL-96'	8	96"	120, 120/208 or 120/240	2205	32 lbs.	1611
GRAL-108	9	108"	120, 120/208 or 120/240	2390	36 lbs.	1940
GRAL-120	10	120"	120, 120/208 or 120/240	2700	40 lbs.	2128
GRAL-132	11	132"	120, 120/208 or 120/240	2980	44 lbs.	2317
GRAL-144	12	144"	120, 120/208 or 120/240	3270	48 lbs.	2509
<b>High Watt</b>						
GRAHL-18	2	18"	120, 120/208 or 120/240	470	8 lbs.	\$ 566
GRAHL-24	2	24"	120, 120/208 or 120/240	620	10 lbs.	589
GRAHL-30	2	30"	120, 120/208 or 120/240	780	11 lbs.	654
GRAHL-36	3	36"	120, 120/208 or 120/240	980	13 lbs.	720
GRAHL-42	3	42"	120, 120/208 or 120/240	1130	16 lbs.	789
GRAHL-48	4	48"	120, 120/208 or 120/240	1340	17 lbs.	857
GRAHL-54	4	54"	120, 120/208 or 120/240	1490	19 lbs.	935
GRAHL-60	5	60"	120, 120/208 or 120/240	1700	21 lbs.	1016
GRAHL-66'	5	66"	120, 120/208 or 120/240	1860	22 lbs.	1111
GRAHL-72'	6	72"	120, 120/208 or 120/240	2085	34 lbs.	1237
GRAHL-84'	7	84"	120, 120/208 or 120/240	2470	40 lbs.	1428
GRAHL-96'	8	96"	120, 120/208 or 120/240	2880	53 lbs.	1619
GRAHL-108	9	108"	120, 120/208 or 120/240	3040	45 lbs.	1948
GRAHL-120	10	120"	120, 120/208 or 120/240	3400	40 lbs.	2136
GRAHL-132	11	132"	120, 120/208 or 120/240	3780	44 lbs.	2325
GRAHL-144	12	144"	120, 120/208 or 120/240	4170	48 lbs.	2517

Model	Width	Voltage Single Phase	Watts	Approx. Ship Weight	List Price <sup>o</sup>
<b>Standard Watt</b>					
GR-18	18"	120, 208 or 240	250	7 lbs.	\$ 529
GR-24	24"	120, 208 or 240	350	7 lbs.	557
GR-36	36"	120, 208 or 240	575	10 lbs.	629
GR-48	48"	120, 208 or 240	800	12 lbs.	684
GR-60	60"	120, 208 or 240	1050	15 lbs.	774
GR-72	72"	120, 208 or 240	1275	19 lbs.	922
GR-96 <sup>o</sup>	96"	120, 208 or 240	1725	24 lbs.	1117
<b>High Watt</b>					
GRH-18	18"	120, 208 or 240	350	8 lbs.	\$ 537
GRH-24	24"	120, 208 or 240	500	7 lbs.	565
GRH-36	36"	120, 208 or 240	800	10 lbs.	637
GRH-48	48"	120, 208 or 240	1100	13 lbs.	692
GRH-60	60"	120, 208 or 240	1400	16 lbs.	782
GRH-72 <sup>o</sup>	72"	120, 208 or 240	1725	19 lbs.	930
GRH-96 <sup>o</sup>	96"	208 or 240	2400	24 lbs.	1125

<sup>o</sup> Does not include Remote Control Enclosure (RMB), see pages 103 and 104.  
<sup>o</sup> Infinite Switch not available in 120V.  
<sup>o</sup> Models longer than 96" require tandem.

**All Stainless Steel Models Feature:**

**Toggle Switch (max. 15 Amps) Location:** Chef's left side.  
**Leads:** 3' conduit with leads – server's right. NEMA 5-15P cord available on 120 volt models 72" or less with C-leg, T-leg stand or chain-hook mount. GRH-72 requires NEMA 5-20P cord for Canada.  
**Dimensions:** 18"-96"W x 6"D x 2 3/4"H.

Contact factory for stainless marine applications.

- <sup>o</sup> Does not include Remote Control Enclosure (RMB), see pages 103 and 104.
- <sup>o</sup> When using an Infinite Control with 120 volt model, additional switch(es) and tandem (end-to-end) elements are required, cord not available.
- <sup>o</sup> 120 volt models require additional switches and tandem (end-to-end) elements.
- <sup>o</sup> 120 volt requires tandem.
- <sup>o</sup> Models 108" and longer are tandem.

**All Glo-Ray Aluminum Infrared Models with Conduit and Lights Feature:**

**Toggle Switch (max. 15 Amps) Location:** Chef's left side – light side (unless otherwise specified).  
**Leads:** 3' conduit with leads – server's right. NEMA 5-15P cord available on 120 volt models 72" or less with C-leg, T-leg stand or hook-chain mount. GRAHL-54, GRAHL-60, GRAL-66 & GRAL-72 require NEMA 5-20P cord for Canada. GRAHL-66 & GRAHL-72 require NEMA 5-20P cord - not available for Canada.

**Dimensions:** 18"-144"W x 9"D x 2 1/2"H.

**OPTIONS AND ACCESSORIES – PAGE 79**  
**RECOMMENDED MOUNTING HEIGHTS – PAGE 101**

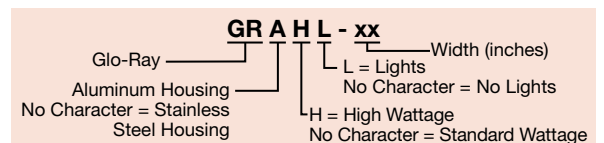



**GRAHL-48**  
with optional  
Sneeze Guard

**OPTIONS** (available at time of purchase only)

**Designer Colors, aluminum models 18"-144" – Non-standard colors are non-returnable – Clear Anodized standard –**

<b>COLOR-6</b>	6" Housing for GRA and GRAH models (color selection below)						per foot	<b>\$35</b>
<b>COLOR-9</b>	9" Housing for GRAL and GRAHL models (color selection below)						per foot	<b>35</b>
	<b>RED</b>	Warm Red	<b>GRAY</b>	Gray Granite	<b>NAVY</b>	Navy Blue	<b>COPPER</b>	Antique Copper
	<b>BLACK</b>	Black	<b>WHITE</b>	White Granite	<b>GREEN</b>	Hunter Green		

**Gloss Finishes, aluminum models 18"-144" – Non-standard colors are non-returnable – Clear Anodized standard –**

<b>GLOSS-6</b>	6" Housing for GRA and GRAH models (finish selection below)						per foot	<b>\$48</b>
<b>GLOSS-9</b>	9" Housing for GRAL and GRAHL models (finish selection below)						per foot	<b>48</b>
	<b>RRED</b>	Radiant Red	<b>GGRAY</b>	Glossy Gray	<b>BBLACK</b>	Bold Black		
	<b>GGOLD</b>	Gleaming Gold	<b>BBLUE</b>	Brilliant Blue				

<b>IND. LGT</b>	Indicator Light (Remote Control only on all Tandem Element units)	<b>\$22</b>
-----------------	---	-------------

**Power Leads – Extended beyond standard 3' Conduit (must specify lead length) –**

<b>LEADS5</b>	1'-5' extended Electrical Leads	<b>\$ 29</b>
<b>LEADS10</b>	6'-10' extended Electrical Leads	<b>58</b>
<b>LEADS15</b>	11'-15' extended Electrical Leads	<b>87</b>
<b>LEADS20</b>	16'-20' extended Electrical Leads	<b>116</b>

**Sneeze Guards**

<b>9.375BP1</b>	9 3/8" Sneeze Guard (aluminum models only) one side	per foot	<b>\$ 77</b>
<b>9.375BP2</b>	9 3/8" Sneeze Guard (aluminum models only) two sides	per foot	<b>154</b>
<b>14BP1</b>	14" Sneeze Guard (aluminum models only) one side	per foot	<b>122</b>
<b>14BP2</b>	14" Sneeze Guard (aluminum models only) two sides	per foot	<b>244</b>
<b>HAL</b>	60 Watt Halogen Bulb in lieu of standard Display Light (aluminum models only)	each	<b>69</b>
<b>NO BULB</b>	No bulb option (GRAL, GRAHL models only)		<b>No Charge</b>
<b>LIGHTS-ADD'L</b>	Extra Lamps – Installed (max. two per foot less one per foot is standard) must be ordered with remote switches only, aluminum models only	each	<b>35</b>
<b>3 ANEAL REFL</b>	Bright Annealed Reflector for Lights (aluminum models only)	per foot	<b>29</b>
<b>NO CONTROL</b>	No control included (GRA, GRAH, GRAL, GRAHL, GR, GRH models only) Requires selection of RMB2-xx control - see page 103		<b>No Charge</b>
<b>BLT INF</b>	Infinite Control Built-In in lieu of Toggle (max. 12.2 Amps) (remote installation recommended)	each	<b>51</b>
<b>REM INF</b>	Remote Infinite Switches in lieu of Toggle (max. 12.2 Amps)	each	<b>51</b>
<b>REM TOG</b>	Remote Toggle Switches (max. 15 Amps)		<b>No Charge</b>
<b>RMB</b>	Remote Control Enclosure (available in Designer Colors or Gloss Finishes) – Non-standard colors are non-returnable –	<b>see pages 103 and 104</b>	

**Stands**

<b>ATL</b>	Adjustable Tubular Stands 10"-14" (not available in Designer Colors) – Not available with cord	1 pair	<b>\$265</b>
<b>NTL-10, -12</b>	Non-Adjustable Tubular Stands (specify 10" or 12" clearance) – Not available with cord	1 pair	<b>122</b>
<b>NTL-14, -16</b>	Non-Adjustable Tubular Stands (specify 14" or 16" clearance) – Not available with cord	1 pair	<b>131</b>
<b>NTL-PAINT</b>	Designer Color or Gloss Finish to match unit color for Non-Adjustable Tubular Stands – Non-standard colors are non-returnable –	1 pair	<b>50</b>
<b>CL-LOW</b>	C-Leg Stands, standard Watt – 10" clearance (for models up to 72" wide) – Only available with cord	1 pair	<b>139</b>
<b>CL-HIGH</b>	C-Leg Stands, High Watt – 13 1/2" clearance (for models up to 72" wide) – Only available with cord	1 pair	<b>157</b>
<b>TL-10</b>	T-Leg Stands, standard Watt – 10" clearance (for models only up to 72" wide) – Only available with cord	1 pair	<b>337</b>
<b>TL-13</b>	T-Leg Stands, 13 1/2" clearance (for models up to 72" wide) – Only available with cord	1 pair	<b>372</b>
<b>TL-16</b>	T-Leg Stands, 16" clearance (for models up to 72" wide) – Only available with cord	1 pair	<b>395</b>
<b>TL-18</b>	T-Leg Stands, 18" clearance (for models up to 72" wide) – Only available with cord	1 pair	<b>424</b>
<b>CAP</b>	Attached 6' Cord and Plug Set (120V only) on models up to 72" wide, requires standard Chain Mount Kit (two S Hooks with two 6" lengths of chain) or add optional C-leg Stands or T-leg Stands (see specific model for plug configuration)		<b>40</b>
<b>CHAIN-HOOK</b>	Two S Hooks with two 6" lengths of chain	each	<b>15</b>

**ACCESSORIES** (available for purchase at any time)

<b>ADJ ANGLE</b>	Adjustable Angle Brackets (GRA, GRAH models only) (see page 102 for illustration)	1 pair	<b>\$ 31</b>
<b>ADJ ANGLE7</b>	7" tall Adjustable Angle Brackets (see page 102 for illustration)	1 pair	<b>37</b>
<b>GR-ANGLE</b>	Adjustable Angle Brackets (GR models only) (see page 102 for illustration)	1 pair	<b>31</b>
<b>CHAIN 1</b>	Chain Suspension (see page 102 for illustration)	per foot	<b>15</b>

**Chef LED Bulb 120V adjustable bulb – GRAL, GRAHL models only, all voltages**

	GRAHL requires pass-through usage only and unit must be 10" or higher from surface – bulbs must be rotated down –		
<b>CLED-3000-120</b>	Similar to warm Halogen light	<b>CLED-4000-120</b>	Similar to cool Fluorescent light
		each	<b>139</b>

**COLORS AND FINISHES – INSIDE BACK COVER**

Strip Heaters





# Glo-Ray® Aluminium Dual Infrared Strip Heaters

Create a deeper holding area with Glo-Ray Aluminium Dual Infrared Strip Heaters mounted side-by-side, keeping hot food at optimum serving temperatures. The pre-focused heat pattern directs heat from a metal-sheathed element across the entire holding surface. The continuous aluminum housing and heavy-duty mountings ensure the durability and quality of Hatco products.

- Ensures maximum flavor, safety and holding time
- Provides even heat distribution, no "cold spots"
- Sturdy extruded aluminum housings that do not sag, from 18" to 144" (12')
- Reflector does not blacken, maintaining a consistent heat pattern
- Protective wire guard supports heating element without affecting heat distribution
- 3" or 6" spacer available
- Heavy-duty insulation minimizes heat loss
- Additional reflector styles and lower wattage elements available, consult factory for more information



**GRAH-72D** with optional Designer Warm Red, 6" spacer and tandem elements

**GRA-36D** with standard 3" spacer

**Toggle Switch:** Max. 15 Amps  
**Infinite Switch:** Max. 12.2 Amps

**NOTE:** 120V models may require additional switches depending on unit or wattage.

## GLO-RAY ALUMINUM DUAL INFRARED STRIP HEATERS

Strip Heaters

Model	Width	Voltage		Watts	Approx. Ship Weight	List Price <sup>o</sup>	
		Single Phase				3" Spacer	6" Spacer
<b>Standard Watt</b>							
GRA-18D	18"	120, 208 or 240		500	14 lbs.	\$ 870	\$ 885
GRA-24D	24"	120, 208 or 240		700	16 lbs.	908	923
GRA-30D	30"	120, 208 or 240		900	18 lbs.	1005	1026
GRA-36D	36"	120, 208 or 240		1150	19 lbs.	1102	1123
GRA-42D	42"	120, 208 or 240		1350	23 lbs.	1199	1220
GRA-48D	48"	120, 208 or 240		1600	27 lbs.	1295	1323
GRA-54D	54"	120, 208 or 240		1850	30 lbs.	1391	1419
GRA-60D	60"	120, 208 or 240		2100	35 lbs.	1499	1542
GRA-66D	66"	120, 208 or 240		2320	36 lbs.	1648	1691
GRA-72D	72"	120, 208 or 240		2550	36 lbs.	1846	1889
GRA-84D <sup>h</sup>	84"	120, 208 or 240		3000	50 lbs.	2136	2194
GRA-96D <sup>h↔</sup>	96"	120, 208 or 240		3450	52 lbs.	2435	2493
GRA-108D <sup>o↔</sup>	108"	120, 208 or 240		3700	59 lbs.	2930	2988
GRA-120D <sup>o↔</sup>	120"	120, 208 or 240		4200	66 lbs.	3199	3288
GRA-132D <sup>o↔</sup>	132"	120, 208 or 240		4640	73 lbs.	3471	3560
GRA-144D <sup>o↔</sup>	144"	120, 208 or 240		5100	80 lbs.	3750	3839
<b>High Watt</b>							
GRAH-18D	18"	120, 208 or 240		700	14 lbs.	\$ 886	\$ 901
GRAH-24D	24"	120, 208 or 240		1000	16 lbs.	924	939
GRAH-30D	30"	120, 208 or 240		1320	18 lbs.	1021	1042
GRAH-36D	36"	120, 208 or 240		1600	19 lbs.	1118	1139
GRAH-42D	42"	120, 208 or 240		1900	24 lbs.	1215	1236
GRAH-48D	48"	120, 208 or 240		2200	27 lbs.	1311	1339
GRAH-54D	54"	120, 208 or 240		2500	30 lbs.	1407	1435
GRAH-60D	60"	120, 208 or 240		2800	37 lbs.	1515	1558
GRAH-66D <sup>h</sup>	66"	120, 208 or 240		3120	38 lbs.	1664	1707
GRAH-72D <sup>h</sup>	72"	120, 208 or 240		3450	36 lbs.	1862	1905
GRAH-84D <sup>h</sup>	84"	120, 208 or 240		4100	50 lbs.	2152	2210
GRAH-96D <sup>h↔</sup>	96"	120, 208 or 240		4800	52 lbs.	2451	2509
GRAH-108D <sup>o↔</sup>	108"	120, 208 or 240		5000	59 lbs.	2946	3004
GRAH-120D <sup>o↔</sup>	120"	120, 208 or 240		5600	66 lbs.	3215	3304
GRAH-132D <sup>o↔</sup>	132"	208 or 240		6240	73 lbs.	3487	3576
GRAH-144D <sup>o↔</sup>	144"	208 or 240		6900	80 lbs.	3766	3855

<sup>o</sup> Does not include Remote Control Enclosure (RMB), see pages 103 and 104.  
<sup>h</sup> When using an infinite control with 120 volt model, additional switch(es) and tandem (end-to-end) elements are required.  
<sup>o</sup> Units are available with built-in toggle. Consult factory for additional charges.  
<sup>h</sup> 120 volt models require additional switches and tandem (end-to-end) elements.  
<sup>↔</sup> Models 96" and longer are tandem.

**All Glo-Ray Aluminum Dual Infrared Models Feature:**  
**Toggle Switch (max. 15 Amps) Location:** Chef's left side (unless otherwise specified).  
**Leads:** 3' conduit with leads – server's right.  
**Dimensions: with 3" Spacer (standard):** 18"-144"W x 15"D x 2½"H.  
**with 6" Spacer:** 18"-144"W x 18"D x 2½"H.

**OPTIONS AND ACCESSORIES – PAGE 82**  
**RECOMMENDED MOUNTING HEIGHTS – PAGE 101**

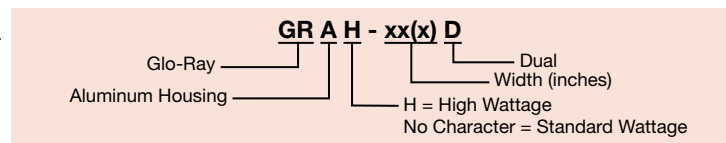



## Glo-Ray® Aluminium Dual Infrared Strip Heaters *continued*

- A** Shown with optional lights (shatter-resistant incandescent lights or halogen bulbs available)
- B** Sturdy extruded aluminum housings that do not sag, from 18" up to 144" (12')
- C** Reflector does not blacken, maintaining a consistent heat pattern
- D** Standard Hanger Tab is provided for under shelf or chain installation
- E** Heavy-duty insulation minimizes heat loss
- F** Metal-sheathed heating element part guaranteed against burnout and breakage for two years
- G** Protective wire guard supports heating element without affecting heat distribution

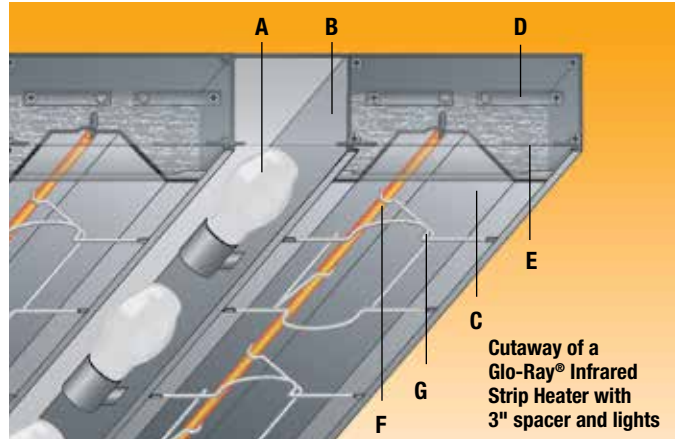

**Toggle Switch:** Max. 15 Amps  
**Infinite Switch:** Max. 12.2 Amps

### GLO-RAY ALUMINUM DUAL INFRARED STRIP HEATERS WITH LIGHTS

Model	Bulbs	Width	Voltage	Watts	Approx. Ship Weight	List Price <sup>o</sup>	
			Single Phase			3" Spacer	6" Spacer
<b>Standard Watt</b>							
GRAL-18D	2	18"	120, 120/208 or 120/240	620	14 lbs.	\$ 967	\$ 982
GRAL-24D	2	24"	120, 120/208 or 120/240	820	16 lbs.	999	1014
GRAL-30D	2	30"	120, 120/208 or 120/240	1020	19 lbs.	1116	1137
GRAL-36D	3	36"	120, 120/208 or 120/240	1330	22 lbs.	1234	1255
GRAL-42D	3	42"	120, 120/208 or 120/240	1530	25 lbs.	1356	1377
GRAL-48D <sup>/</sup>	4	48"	120, 120/208 or 120/240	1840	30 lbs.	1480	1508
GRAL-54D <sup>/</sup>	4	54"	120, 120/208 or 120/240	2090	34 lbs.	1610	1638
GRAL-60D <sup>/</sup>	5	60"	120, 120/208 or 120/240	2400	35 lbs.	1752	1795
GRAL-66D <sup>/</sup>	5	66"	120, 120/208 or 120/240	2620	39 lbs.	1919	1962
GRAL-72D <sup>/</sup>	6	72"	120, 120/208 or 120/240	2910	42 lbs.	2147	2190
GRAL-84D <sup>/</sup>	7	84"	120, 120/208 or 120/240	3420	50 lbs.	2485	2543
GRAL-96D <sup>/</sup>	8	96"	120, 120/208 or 120/240	3930	56 lbs.	2825	2883
GRAL-108D <sup>/∞</sup>	9	108"	120, 120/208 or 120/240	4240	64 lbs.	3358	3416
GRAL-120D <sup>/∞</sup>	10	120"	120, 120/208 or 120/240	4800	72 lbs.	3675	3764
GRAL-132D <sup>/∞</sup>	11	132"	120, 120/208 or 120/240	5300	79 lbs.	3998	4087
GRAL-144D <sup>/∞</sup>	12	144"	120, 120/208 or 120/240	5820	86 lbs.	4324	4413
<b>High Watt</b>							
GRAHL-18D	2	18"	120, 120/208 or 120/240	820	14 lbs.	\$ 983	\$ 998
GRAHL-24D	2	24"	120, 120/208 or 120/240	1120	16 lbs.	1015	1030
GRAHL-30D	2	30"	120, 120/208 or 120/240	1440	19 lbs.	1132	1153
GRAHL-36D <sup>/</sup>	3	36"	120, 120/208 or 120/240	1780	22 lbs.	1250	1271
GRAHL-42D <sup>/</sup>	3	42"	120, 120/208 or 120/240	2080	25 lbs.	1372	1393
GRAHL-48D <sup>/</sup>	4	48"	120, 120/208 or 120/240	2440	30 lbs.	1496	1524
GRAHL-54D <sup>/</sup>	4	54"	120, 120/208 or 120/240	2740	33 lbs.	1626	1654
GRAHL-60D <sup>/</sup>	5	60"	120, 120/208 or 120/240	3100	37 lbs.	1768	1811
GRAHL-66D <sup>/</sup>	5	66"	120, 120/208 or 120/240	3420	38 lbs.	1935	1978
GRAHL-72D <sup>/</sup>	6	72"	120, 120/208 or 120/240	3810	42 lbs.	2163	2206
GRAHL-84D <sup>/∞</sup>	7	84"	120, 120/208 or 120/240	4520	50 lbs.	2501	2559
GRAHL-96D <sup>/∞</sup>	8	96"	120, 120/208 or 120/240	5280	54 lbs.	2841	2899
GRAHL-108D <sup>/∞</sup>	9	108"	120, 120/208 or 120/240	5540	64 lbs.	3374	3432
GRAHL-120D <sup>/∞</sup>	10	120"	120, 120/208 or 120/240	6200	72 lbs.	3691	3780
GRAHL-132D <sup>∞</sup>	11	132"	120, 120/208 or 120/240	6900	79 lbs.	4014	4103
GRAHL-144D <sup>∞</sup>	12	144"	120/208 or 120/240	7620	86 lbs.	4340	4429

<sup>o</sup> Does not include Remote Control Enclosure (RMB), see pages 103 and 104.  
<sup>/</sup> When using an infinite control with 120 volt model, additional switch(es) and tandem (end-to-end) elements required.  
<sup>/</sup> 120v models with infinite controls require additional switches.  
<sup>∞</sup> Glo-Ray models 108"-144" and 120V models of GRAH(L)-84D and GRAH(L)-96D contain tandem (end-to-end) elements that may be individually controlled.

**All Glo-Ray Aluminum Dual Models with Lights Feature:**  
**Toggle Switch (max. 15 Amps) Location:** Chef's left side (unless otherwise specified).  
 Built-In infinite switch not available.  
**Leads:** 3' conduit with leads – server's right.  
**Dimensions:** with 3" Spacer (standard): 15"D x 2 1/2"H.  
 with 6" Spacer: 18"D x 2 1/2"H.

**OPTIONS AND ACCESSORIES – PAGE 82**  
**RECOMMENDED MOUNTING HEIGHTS – PAGE 101**

**NOTE:** For multiple circuit control options used with optional Tubular Stand Supports (ATL or NTL), the power supply may need to be located somewhere other than through the Tubular Stand. Consult factory for details.

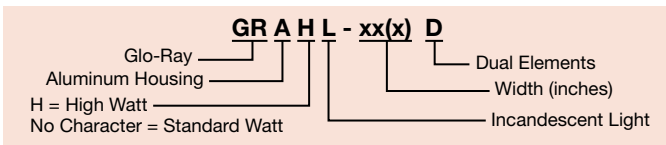

Strip Heaters



A series of GRAH-60D models

Strip Heaters

**OPTIONS** (available at time of purchase only)

**Designer Colors, aluminum models 18"-144" – Non-standard colors are non-returnable – Clear Anodized standard –**

<b>COLOR-15, -18</b>	15" and 18" Housings for GRA, GRAH, GRAL and GRAHL Dual models (Clear Anodized standard)						per foot	\$50
<b>RED</b>	Warm Red	<b>GRAY</b>	Gray Granite	<b>NAVY</b>	Navy Blue	<b>COPPER</b>	Antique Copper	
<b>BLACK</b>	Black	<b>WHITE</b>	White Granite	<b>GREEN</b>	Hunter Green			

**Gloss Finishes, aluminum models 18"-144" – Non-standard colors are non-returnable – Clear Anodized standard –**

<b>GLOSS-15, -18</b>	15" and 18" Housings for GRA, GRAH, GRAL and GRAHL Dual models (Clear Anodized standard)						per foot	\$64
<b>RRED</b>	Radiant Red	<b>GGRAY</b>	Glossy Gray	<b>BBLACK</b>	Bold Black			
<b>GGOLD</b>	Gleaming Gold	<b>BBLUE</b>	Brilliant Blue					
<b>IND. LGT</b>	Indicator Light (remote only)							\$22

**Power Leads – Extended beyond standard 3' Conduit (must specify lead length) –**

<b>LEADS5</b>	1'-5' extended Electrical Leads	\$	29
<b>LEADS10</b>	6'-10' extended Electrical Leads		58
<b>LEADS15</b>	11'-15' extended Electrical Leads		87
<b>LEADS20</b>	16'-20' extended Electrical Leads		116

<b>9.375BP1</b>	9 <sup>3</sup> / <sub>8</sub> " Sneeze Guard, one side	per foot	\$ 77
<b>9.375BP2</b>	9 <sup>3</sup> / <sub>8</sub> " Sneeze Guard, two sides	per foot	154
<b>14BP1</b>	14" Sneeze Guard, one side	per foot	122
<b>14BP2</b>	14" Sneeze Guard, two sides	per foot	244
<b>HAL</b>	60 Watt Halogen Bulb in lieu of standard Display Light	each	69
<b>NO BULB</b>	No bulb option (GRAL-xxD, GRAHL-xxD models only)		No Charge
<b>LIGHTS-ADD'L</b>	Extra Lamps – Installed (maximum two per foot less one – one per foot is standard)	each	35
<b>3 ANEAL REFL</b>	Bright Annealed Reflector for lights with 3" Spacer	per foot	29
<b>6 ANEAL REFL</b>	Bright Annealed Reflector for lights with 6" Spacer	per foot	43
<b>NO CONTROL</b>	No control included (GRA, GRAH, GRAL, GRAHL-xxD models only) Requires selection of RMB2-xx control (see page 103)		No Charge
<b>REM INF</b>	Remote Infinite Switches (max. 12.2 Amps)	each	51
<b>REM TOG</b>	Remote Toggle Switches (max. 15 Amps)		No Charge
<b>RMB</b>	Remote Control Enclosure (available in Designer Colors or Gloss Finishes) – Non-standard colors are non-returnable – Clear Anodized standard –	see page 103 and 104	
<b>ATL-D</b>	Adjustable Tubular Stands 10"-14" (not available in Designer Colors)	2 pair	\$530
<b>NTL-10-D, -12-D</b>	Non-Adjustable Tubular Stands (specify 10" or 12" clearance)	2 pair	244
<b>NTL-14-D, -16-D</b>	Non-Adjustable Tubular Stands (specify 14" or 16" clearance)	2 pair	262
<b>NTL-PAINT-D</b>	Designer Color or Gloss Finish for Non-Adjustable Tubular Stands to match unit color – Non-standard colors are non-returnable –	2 pair	100

**ACCESSORIES** (available for purchase at any time)

<b>ADJ ANGLE-D</b>	Adjustable Angle Brackets for Dual models (see page 102 for illustration)	2 pair	\$ 62
<b>ADJ ANGLE7-D</b>	7" tall Adjustable Angle Brackets for Dual models (see page 102 for illustration)	2 pair	74
<b>CHAIN 1</b>	Chain Suspension (see page 102 for illustration)	per foot	15
<b>Chef LED 120V adjustable bulb – GRAL-xxD, GRAHL-xxD models only, all voltages – pass-through usage only</b>			
GRAL-xxD must be 15" or higher from surface, GRAHL-xxD must be 18" or higher from surface as pass through – Bulbs must be rotated down –			
<b>CLED-3000-120</b>	Similar to warm Halogen light	<b>CLED-4000-120</b>	Similar to cool Fluorescent light
		each	139

**COLORS AND FINISHES – INSIDE BACK COVER**

## Glo-Ray® Aluminium Max Watt Infrared Strip Heaters

Safely hold the temperature of your product without drying out or further cooking food with Hatco's Glo-Ray Aluminium Max Watt Infrared Strip Heaters. The end result is hot, fresh food that's ready-to-serve. The continuous aluminum housing and heavy-duty mountings ensure the durability and quality of Hatco products.

- Features 25% greater wattage output than Glo-Ray high watt by comparison with single units varying in watts from 450 to 4150 watts; and units with lights varying from 570 to 4870 watts
- Sturdy extruded aluminum housings that do not sag, from 18" to 72" in 6" increments and 84" to 144" in 12" increments
- Protective wire guards under heating element
- Available options include Built-in Toggle Control, Toggle Control Remote Box, Electronic Infinite Control Remote Box or loose Remote Controls.
- Shatter-resistant incandescent lights (standard on GRAML models) enhance product display while safeguarding food products from bulb breakage. An optional halogen bulb may be used in lieu of incandescents
- Additional reflector styles available, consult factory for more information
- Heavy-duty insulation minimizes heat loss



GRAM-36



GRAML-36 with shatter-resistant incandescent lights and standard angle brackets

### GLO-RAY ALUMINUM MAX WATT INFRARED STRIP HEATERS

### GLO-RAY ALUMINUM MAX WATT INFRARED STRIP HEATERS with LIGHTS

Model	Width	Voltage Single Phase	Watts	Approx. Ship Weight <sup>▲</sup>	List Price <sup>◎</sup>
<b>Max Watt</b>					
GRAM-18	18"	120, 208 or 240	450	9 lbs.	\$ 544
GRAM-24	24"	120, 208 or 240	650	10 lbs.	562
GRAM-30	30"	120, 208 or 240	825	10 lbs.	590
GRAM-36	36"	120, 208 or 240	1000	12 lbs.	605
GRAM-42	42"	120, 208 or 240	1175	12 lbs.	632
GRAM-48	48"	120, 208 or 240	1300	15 lbs.	660
GRAM-54	54"	120, 208 or 240	1500	16 lbs.	690
GRAM-60	60"	120, 208 or 240	1700	17 lbs.	721
GRAM-66 <sup>↗</sup>	66"	120, 208 or 240	1875	21 lbs.	791
GRAM-72 <sup>↗</sup>	72"	120, 208 or 240	2075	21 lbs.	863
GRAM-84 <sup>↘</sup>	84"	120, 208 or 240	2400	22 lbs.	957
GRAM-96 <sup>↘</sup>	96"	120, 208 or 240	2675	25 lbs.	1055
GRAM-108 <sup>∞</sup>	108"	208 or 240	3000	23 lbs.	1234
GRAM-120 <sup>∞</sup>	120"	208 or 240	3400	26 lbs.	1322
GRAM-132 <sup>∞</sup>	132"	208 or 240	3750	30 lbs.	1405
GRAM-144 <sup>∞</sup>	144"	208 or 240	4150	33 lbs.	1496

Model	Bulbs	Width	Voltage Single Phase	Watts	Approx. Ship Weight <sup>▲</sup>	List Price <sup>◎</sup>
<b>Max Watt</b>						
GRAML-18	2	18"	120, 120/208 or 120/240	570	10 lbs.	\$ 757
GRAML-24	2	24"	120, 120/208 or 120/240	770	13 lbs.	773
GRAML-30	2	30"	120, 120/208 or 120/240	945	15 lbs.	847
GRAML-36	3	36"	120, 120/208 or 120/240	1180	15 lbs.	901
GRAML-42	3	42"	120, 120/208 or 120/240	1355	19 lbs.	956
GRAML-48	4	48"	120, 120/208 or 120/240	1540	20 lbs.	1025
GRAML-54	4	54"	120, 120/208 or 120/240	1740	24 lbs.	1101
GRAML-60 <sup>◎</sup>	5	60"	120, 120/208 or 120/240	2000	22 lbs.	1178
GRAML-66 <sup>◎↗</sup>	5	66"	120, 120/208 or 120/240	2175	25 lbs.	1328
GRAML-72 <sup>◎↗</sup>	6	72"	120, 120/208 or 120/240	2435	29 lbs.	1442
GRAML-84 <sup>◎↘</sup>	7	84"	120, 120/208 or 120/240	2820	32 lbs.	1620
GRAML-96 <sup>◎↘</sup>	8	96"	120, 120/208 or 120/240	3155	37 lbs.	1797
GRAML-108 <sup>∞◎</sup>	9	108"	120/208 or 120/240	3540	36 lbs.	2094
GRAML-120 <sup>∞◎</sup>	10	120"	120/208 or 120/240	4000	40 lbs.	2266
GRAML-132 <sup>∞◎</sup>	11	132"	120/208 or 120/240	4410	44 lbs.	2445
GRAML-144 <sup>∞◎</sup>	12	144"	120/208 or 120/240	4870	48 lbs.	2628

- ▲ Add 2-8 lbs. depending on Remote Control Enclosure (RMB).
- ◎ Includes either Remote Control Enclosure (RMB) with toggle switch(es) and indicator light(s) or Attached Control Enclosure with toggle switch(es) except as noted (please specify).
- ↗ 120 volt models with built in controls require tandem (end-to-end) elements.
- ↘ 120 volt models require additional switches and tandem (end-to-end) elements.
- ∞ Models contain tandem (end-to-end) elements that may be individually controlled.

- ▲ Add 2-8 lbs. depending on Remote Control Enclosure (RMB).
- ◎ Includes Remote Control Enclosure (RMB) with toggle switch(es) and indicator light(s) or Attached Control Enclosure with toggle switch(es) except as noted (please specify).
- ◎ 120 volt models not available with Built-in Controls.
- ↗ 120 volt models with built in controls require tandem (end-to-end) elements.
- ↘ 120 volt models require additional switches and tandem (end-to-end) elements.
- ∞ Models contain tandem (end-to-end) elements that may be individually controlled.
- ◎ All voltages not available with Built-in Controls.

**All Glo-Ray Aluminum Max Watt Infrared Models Feature:**  
**Includes:** Angle Brackets and Attached or Remote Control Enclosure (RMB).  
**Leads:** 3' conduit with leads – server's right.  
**Dimensions:** 18"-144"W x 6"D x 2½"H.

**All Glo-Ray Aluminum Max Watt Infrared Models with Lights Feature:**  
**Includes:** Angle Brackets and Attached or Remote Control Enclosure (RMB).  
**Leads:** 3' conduit with leads – server's right.  
**Dimensions:** 18"-144"W x 9"D x 2½"H.

**OPTIONS AND ACCESSORIES – PAGE 84**  
**RECOMMENDED MOUNTING HEIGHTS – PAGE 101**

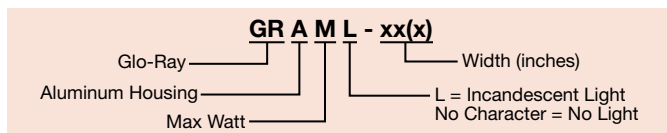



**GRAML-48**  
with standard  
angle brackets

Strip Heaters

**OPTIONS** (available at time of purchase only)

**Designer Colors, aluminum models 18"-144" – Non-standard colors are non-returnable – Clear Anodized standard –**

<b>COLOR-6</b>	6" Housing for GRAM models						per foot	<b>\$35</b>
	<b>RED</b> Warm Red	<b>GRAY</b> Gray Granite	<b>NAVY</b> Navy Blue	<b>COPPER</b> Antique Copper				
	<b>BLACK</b> Black	<b>WHITE</b> White Granite	<b>GREEN</b> Hunter Green					
<b>COLOR-9</b>	9" Housing for GRAML models						per foot	<b>35</b>
	<b>RED</b> Warm Red	<b>GRAY</b> Gray Granite	<b>NAVY</b> Navy Blue	<b>COPPER</b> Antique Copper				
	<b>BLACK</b> Black	<b>WHITE</b> White Granite	<b>GREEN</b> Hunter Green					
<b>RMB-COLOR</b>	Remote Control Enclosure Housing in <i>Designer Colors</i> (select color below)							<b>50</b>
	<b>RED</b> Warm Red	<b>GRAY</b> Gray Granite	<b>NAVY</b> Navy Blue	<b>COPPER</b> Antique Copper				
	<b>BLACK</b> Black	<b>WHITE</b> White Granite	<b>GREEN</b> Hunter Green					

**Gloss Finishes, aluminum models 18"-144" – Non-standard colors are non-returnable – Clear Anodized standard –**

<b>GLOSS-6</b>	6" Housing for GRAM models						per foot	<b>\$48</b>
	<b>RRED</b> Radiant Red	<b>GGRAY</b> Glossy Gray	<b>BBLACK</b> Bold Black					
	<b>GGOLD</b> Gleaming Gold	<b>BBLUE</b> Brilliant Blue						
<b>GLOSS-9</b>	9" Housing for GRAML models						per foot	<b>48</b>
	<b>RRED</b> Radiant Red	<b>GGRAY</b> Glossy Gray	<b>BBLACK</b> Bold Black					
	<b>GGOLD</b> Gleaming Gold	<b>BBLUE</b> Brilliant Blue						
<b>RMB-GLOSS</b>	Remote Control Enclosure Housing in Gloss Finishes – <i>Non-standard colors are non-returnable – Clear Anodized standard –</i>							<b>71</b>
	<b>RRED</b> Radiant Red	<b>GGRAY</b> Glossy Gray	<b>BBLACK</b> Bold Black					
	<b>GGOLD</b> Gleaming Gold	<b>BBLUE</b> Brilliant Blue						

**Power Leads – Extended beyond standard 3' Conduit (must specify lead length) –**

<b>HTLEADS5</b>	1'-5' extended Electrical Leads	<b>\$ 41</b>
<b>HTLEADS10</b>	6'-10' extended Electrical Leads	<b>82</b>
<b>HTLEADS15</b>	11'-15' extended Electrical Leads	<b>123</b>
<b>HTLEADS20</b>	16'-20' extended Electrical Leads	<b>164</b>
<b>3 ANEAL REFL</b>	Bright Annealed Reflector for lights with 3" Spacer	per foot <b>\$ 29</b>

**RMB-GRAM-INF** Remote Control Enclosure with Toggle Control Switch, Electronic Infinite Control, Relay and Indicator Light (in lieu of standard Remote Control Enclosure)

<b>BLT TOG</b>	Built in Control - available for GRAML models only	<b>No Charge</b>
<b>NTL-14, -16</b>	Non-Adjustable Tubular Stands – specify 14" or 16" clearance	pair <b>131</b>
<b>NTL-18, -20</b>	Non-Adjustable Tubular Stands – specify 18" or 20" clearance	pair <b>139</b>
<b>NTL-22, -24</b>	Non-Adjustable Tubular Stands – specify 22" or 24" clearance	pair <b>150</b>
<b>NTL-PAINT</b>	<i>Designer Color or Gloss Finish for Non-Adjustable Tubular Stands (one pair) – Non-standard colors are non-returnable –</i>	pair <b>50</b>

	<b>RED</b> Warm Red	<b>GRAY</b> Gray Granite	<b>NAVY</b> Navy Blue	<b>COPPER</b> Antique Copper			
	<b>BLACK</b> Black	<b>WHITE</b> White Granite	<b>GREEN</b> Hunter Green				
	<b>RRED</b> Radiant Red	<b>GGRAY</b> Glossy Gray	<b>BBLACK</b> Bold Black				
	<b>GGOLD</b> Gleaming Gold	<b>BBLUE</b> Brilliant Blue					

**CAP** Attached 6' Cord and Plug Set (120V only) on models up to 48" requires built-in controls and standard Chain Mount Kit: Two S Hooks with two 6" lengths of chain (available for GRAM models only)

<b>CHAIN-HOOK</b>	Two S Hooks with two 6" lengths of chain	each <b>15</b>
<b>HAL</b>	60 Watt Halogen Bulb in lieu of standard Display Light	each <b>69</b>
<b>NO BULB</b>	No bulb option (GRAML models only)	<b>No Charge</b>

**ACCESSORIES** (available for purchase at any time)

<b>CHAIN 1</b>	Chain Suspension	per foot <b>\$ 15</b>
<b>Chef LED 120V adjustable bulb – GRAML-xx models only, all voltages – pass-through usage only</b>		
GRAML-xx must be 13" or higher from surface as pass through – bulbs must be rotated down –		
	<b>CLED-3000-120</b> Similar to warm Halogen light	<b>CLED-4000-120</b> Similar to cool Fluorescent light
		each <b>139</b>

**COLORS AND FINISHES – INSIDE BACK COVER**



## Glo-Ray® Aluminum Max Watt Dual Infrared Strip Heaters

Create a deeper holding area with Glo-Ray Aluminium Max Watt Dual Aluminum Infrared Strip Heaters mounted side-by-side, keeping hot food at optimum serving temperatures. The pre-focused heat pattern directs heat from a metal-sheathed element, bathing the entire holding surface. The continuous aluminum housing and heavy-duty mountings ensure the durability and quality of Hatco products.

- Features 25% greater wattage output than Glo-Ray high watt by comparison with dual units varying in wattage from 900 to 8300 watts; and units with lights varying from 1020 to 9020 watts
- Sturdy extruded aluminum housings that do not sag, from 18" to 72" in 6" increments and 84" to 144" in 12" increments
- Protective wire guard supports heating element without affecting heat distribution
- 3" or 6" spacer available
- Heavy-duty insulation minimizes heat loss
- Shatter-resistant incandescent lights (standard on GRAML models) enhance product display while safeguarding food products from bulb breakage. An optional halogen bulb may be used in lieu of incandescents
- Additional reflector styles available, consult factory for more information



**GRAM-36D**  
with standard 3" spacer

### GLO-RAY ALUMINUM MAX WATT DUAL INFRARED STRIP HEATERS

Model	Width	Voltage		Watts	Approx. Ship Weight*	List Price <sup>©</sup>	
		Single Phase				3" Spacer	6" Spacer
<b>Max Watt</b>							
GRAM-18D	18"	120, 208 or 240		900	13 lbs.	\$1050	\$1065
GRAM-24D	24"	120, 208 or 240		1300	18 lbs.	1089	1104
GRAM-30D	30"	120, 208 or 240		1650	20 lbs.	1175	1196
GRAM-36D	36"	120, 208 or 240		2000	23 lbs.	1259	1280
GRAM-42D	42"	120, 208 or 240		2350	27 lbs.	1346	1367
GRAM-48D	48"	120, 208 or 240		2600	34 lbs.	1435	1463
GRAM-54D	54"	120, 208 or 240		3000	32 lbs.	1531	1559
GRAM-60D	60"	120, 208 or 240		3400	35 lbs.	1634	1677
GRAM-66D <sup>☒</sup>	66"	120, 208 or 240		3750	37 lbs.	1855	1898
GRAM-72D <sup>☒</sup>	72"	120, 208 or 240		4150	43 lbs.	2061	2104
GRAM-84D <sup>☒</sup>	84"	120, 208 or 240		4800	44 lbs.	2318	2376
GRAM-96D <sup>☒</sup>	96"	120, 208 or 240		5350	54 lbs.	2577	2635
GRAM-108D <sup>☒</sup>	108"	208 or 240		6000	59 lbs.	3027	3085
GRAM-120D <sup>☒</sup>	120"	208 or 240		6800	66 lbs.	3284	3373
GRAM-132D <sup>☒</sup>	132"	208 or 240		7500	73 lbs.	3536	3625
GRAM-144D <sup>☒</sup>	144"	208 or 240		8300	80 lbs.	3790	3879

\* Add 2-8 lbs. depending on Remote Control Enclosure (RMB).

© Includes Remote Control Enclosure (RMB) with toggle switch(es) and indicator light(s). Built-in controls not available.

☒ 120v models require tandem (end-to-end) elements.

☒ Units longer than 96" require tandem regardless of voltage.

#### All Glo-Ray Aluminum Max Watt Dual Infrared Models Feature:

**Includes:** Angle Brackets and Remote Control Enclosure (RMB).

**Leads:** 3' conduit with leads – server's right.

**Dimensions:** with 3" Spacer (standard): 18"-144"W x 15"D x 2½"H.  
with 6" Spacer: 18"-144"W x 18"D x 2½"H.

**OPTIONS AND ACCESSORIES – PAGE 87**  
**RECOMMENDED MOUNTING HEIGHTS – PAGE 101**

Strip Heaters

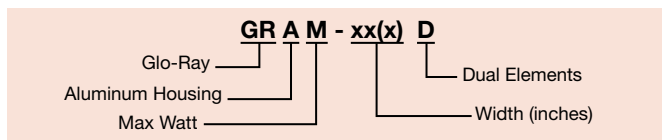

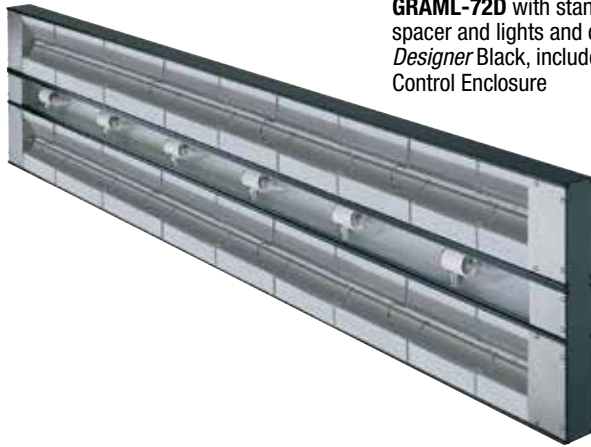

**GRAML-72D** with standard 3" spacer and lights and optional Black Designer Black, includes Remote Control Enclosure

**GLO-RAY ALUMINUM MAX WATT DUAL INFRARED STRIP HEATERS with LIGHTS**

Model	Bulbs	Width	Voltage	Watts	Approx. Ship Weight <sup>▲</sup>	List Price <sup>◎</sup>	
			Single Phase			3" Spacer	6" Spacer
<b>Max Watt</b>							
GRAML-18D	2	18"	120, 120/208 or 120/240	1020	15 lbs.	<b>\$1196</b>	<b>\$1211</b>
GRAML-24D	2	24"	120, 120/208 or 120/240	1420	19 lbs.	<b>1230</b>	<b>1245</b>
GRAML-30D	2	30"	120, 120/208 or 120/240	1770	20 lbs.	<b>1344</b>	<b>1365</b>
GRAML-36D	3	36"	120, 120/208 or 120/240	2180	22 lbs.	<b>1442</b>	<b>1463</b>
GRAML-42D	3	42"	120, 120/208 or 120/240	2530	29 lbs.	<b>1556</b>	<b>1577</b>
GRAML-48D	4	48"	120, 120/208 or 120/240	2840	33 lbs.	<b>1663</b>	<b>1691</b>
GRAML-54D	4	54"	120, 120/208 or 120/240	3240	34 lbs.	<b>1788</b>	<b>1816</b>
GRAML-60D	5	60"	120, 120/208 or 120/240	3700	38 lbs.	<b>1913</b>	<b>1956</b>
GRAML-66D <sup>✓</sup>	5	66"	120, 120/208 or 120/240	4050	43 lbs.	<b>2156</b>	<b>2199</b>
GRAML-72D <sup>✓</sup>	6	72"	120, 120/208 or 120/240	4510	45 lbs.	<b>2382</b>	<b>2425</b>
GRAML-84D <sup>✓</sup>	7	84"	120, 120/208 or 120/240	5220	49 lbs.	<b>2673</b>	<b>2731</b>
GRAML-96D <sup>✓</sup>	8	96"	120, 120/208 or 120/240	5830	60 lbs.	<b>3467</b>	<b>3525</b>
GRAML-108D	9	108"	120/208 or 120/240	6540	64 lbs.	<b>3419</b>	<b>3477</b>
GRAML-120D	10	120"	120/208 or 120/240	7400	72 lbs.	<b>3728</b>	<b>3817</b>
GRAML-132D	11	132"	120/208 or 120/240	8160	79 lbs.	<b>4041</b>	<b>4130</b>
GRAML-144D	12	144"	120/208 or 120/240	9020	86 lbs.	<b>4356</b>	<b>4445</b>

Strip Heaters

- ◎ Includes Remote Control Enclosure (RMB) with toggle switch(es) and indicator light(s). Built-In controls not available.
  - ▲ Add 2-8 lbs. depending on Remote Control Enclosure (RMB).
  - ✓ 120 volt units require tandem (end to end) elements.
  - ✓ GRAML-96D 120v not available with infinite controls.
- Note:** Other control options available, consult factory.

**All Glo-Ray Aluminum Max Watt Dual Infrared Models with Lights Feature:**

**Includes:** Angle Brackets and Remote Control Enclosure (RMB).  
**Leads:** 3' conduit with leads – server's right.  
**Dimensions:** with 3" Spacer (standard): 15"D x 2½"H.  
 with 6" Spacer: 18"D x 2½"H.

**OPTIONS AND ACCESSORIES – PAGE 87**  
**RECOMMENDED MOUNTING HEIGHTS – PAGE 101**

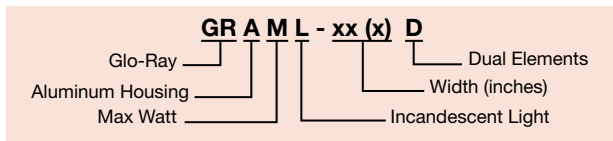



GRAML-60D with optional non-adjustable tubular stands

Strip Heaters

**OPTIONS** (available at time of purchase only)

**Designer Colors, aluminum models 18"-144" – Non-standard colors are non-returnable – Clear Anodized standard –**

<b>COLOR-15, -18</b>	15" and 18" Housings for GRAM and GRAML Dual models						per foot	\$50
	<b>RED</b> Warm Red	<b>GRAY</b> Gray Granite	<b>NAVY</b> Navy Blue	<b>COPPER</b> Antique Copper				
	<b>BLACK</b> Black	<b>WHITE</b> White Granite	<b>GREEN</b> Hunter Green					
<b>RMB-COLOR</b>	Remote Control Enclosure Housing in Designer Colors – Non-standard colors are non-returnable – Clear Anodized standard –							50
	<b>RED</b> Warm Red	<b>GRAY</b> Gray Granite	<b>NAVY</b> Navy Blue	<b>COPPER</b> Antique Copper				
	<b>BLACK</b> Black	<b>WHITE</b> White Granite	<b>GREEN</b> Hunter Green					

**Gloss Finishes, aluminum models 18"-144" – Non-standard colors are non-returnable – Clear Anodized standard –**

<b>GLOSS-15, -18</b>	15" and 18" Housings for GRAM and GRAML Dual models						per foot	\$64
	<b>RRED</b> Radiant Red	<b>GGRAY</b> Glossy Gray	<b>BBLACK</b> Bold Black					
	<b>GGOLD</b> Gleaming Gold	<b>BBLUE</b> Brilliant Blue						
<b>RMB-GLOSS</b>	Remote Control Enclosure Housing in Gloss Finishes							71
	<b>RRED</b> Radiant Red	<b>GGRAY</b> Glossy Gray	<b>BBLACK</b> Bold Black					
	<b>GGOLD</b> Gleaming Gold	<b>BBLUE</b> Brilliant Blue						

**Power Leads – Extended beyond standard 3' Conduit (must specify lead length) –**

<b>HTLEADS5</b>	1'-5' extended Electrical Leads		\$ 41
<b>HTLEADS10</b>	6'-10' extended Electrical Leads		82
<b>HTLEADS15</b>	11'-15' extended Electrical Leads		123
<b>HTLEADS20</b>	16'-20' extended Electrical Leads		164
<b>RMB-GRAM-INF</b>	Remote Control Enclosure with Toggle Control Switch, Electronic Infinite Control, Relay and Indicator Light (in lieu of standard Remote Control Enclosure)		484
<b>3 ANEAL REFL</b>	Bright Annealed Reflector for lights with 3" Spacer	per foot	29
<b>6 ANEAL REFL</b>	Bright Annealed Reflector for lights with 6" Spacer	per foot	43

**Stands**

<b>NTL-18-D, -20-D</b>	Non-Adjustable Tubular Stands (specify 18" or 20" clearance)	2 pair	278
<b>NTL-22-D, -24-D</b>	Non-Adjustable Tubular Stands (specify 22" or 24" clearance)	2 pair	300
<b>NTL-PAINT-D</b>	Designer Color or Gloss Finish for Non-Adjustable Tubular Stands to match unit color – Non-standard colors are non-returnable –	2 pair	100
<b>HAL</b>	60 Watt Halogen Bulb in lieu of standard Display Light	each	69
<b>NO BULB</b>	No bulb option (GRAML-xxD models only)		No Charge

**ACCESSORIES** (available for purchase at any time)

**Chef LED 120V adjustable bulb – GRAML-xxD models only, all voltages – pass-through usage only –**

GRAML-xxD must be 18" to 24" from surface as pass through – bulbs must be rotated down –

<b>CLED-3000-120</b>	Similar to warm Halogen light	<b>CLED-4000-120</b>	Similar to cool Fluorescent light	each	\$139
----------------------	-------------------------------	----------------------	-----------------------------------	------	-------

**COLORS AND FINISHES – INSIDE BACK COVER**



## Glo-Ray® Narrow Infrared Strip Heaters

Hatco Glo-Ray® Narrow Infrared Strip Heaters keep all hot foods at optimum serving temperatures longer, while the slim design fits ideally in buffet areas. Even the most delicate dishes hold that “just-prepared” look. The entire holding surface is heated evenly with no “cold” spots.

- Slim design that's 2" high and 4" deep
- Available in widths from 18"-72"
- Pre-focused heat pattern maintains serving temperatures longer without continuing to cook the food
- Optional Remote Control Enclosure (RMB) available in *Designer Colors*



GRN-24 in standard *Designer Black* with standard angle brackets

**Toggle Switch:** Max. 15 Amps  
**Infinite Switch:** Max. 12.2 Amps

### GLO-RAY NARROW INFRARED STRIP HEATERS

Model	Width	Voltage (Single Phase)	Watts	Approx. Ship Weight	List Price <sup>o</sup>
<b>Standard Watt</b>					
GRN-18	18"	120, 208 or 240	250	5 lbs.	\$444
GRN-24	24"	120, 208 or 240	350	6 lbs.	471
GRN-30	30"	120, 208 or 240	450	9 lbs.	500
GRN-36	36"	120, 208 or 240	575	9 lbs.	531
GRN-42	42"	120, 208 or 240	675	9 lbs.	564
GRN-48	48"	120, 208 or 240	800	11 lbs.	598
GRN-54	54"	120, 208 or 240	925	12 lbs.	633
GRN-60	60"	120, 208 or 240	1050	13 lbs.	678
GRN-66	66"	120, 208 or 240	1160	16 lbs.	742
GRN-72	72"	120, 208 or 240	1275	17 lbs.	839
<b>High Watt</b>					
GRNH-18	18"	120, 208 or 240	350	7 lbs.	\$452
GRNH-24	24"	120, 208 or 240	500	6 lbs.	479
GRNH-30	30"	120, 208 or 240	660	7 lbs.	508
GRNH-36	36"	120, 208 or 240	800	8 lbs.	539
GRNH-42	42"	120, 208 or 240	950	9 lbs.	572
GRNH-48	48"	120, 208 or 240	1100	11 lbs.	606
GRNH-54	54"	120, 208 or 240	1250	12 lbs.	641
GRNH-60	60"	120, 208 or 240	1400	13 lbs.	686
GRNH-66	66"	120, 208 or 240	1560	16 lbs.	750
GRNH-72	72"	120, 208 or 240	1725	17 lbs.	847

<sup>o</sup> Does not include Remote Control Enclosure (RMB), see pages 103 and 104.  
 † Infinite Switch not available in 120V. RMB2-1R series Remote Control Enclosure (RMB) required for infinite control.

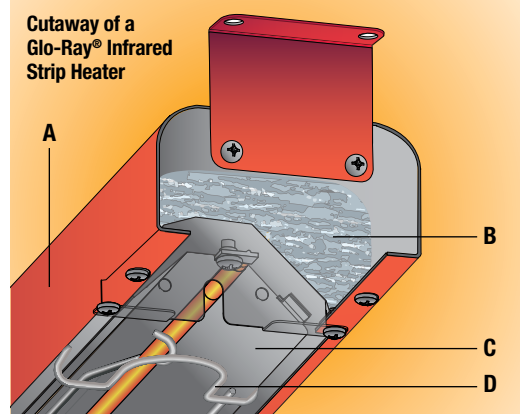

- A** Sturdy housing available in optional Stainless Steel or six optional *Designer Colors* (*Designer Black* standard)
- B** Heavy-duty insulation minimizes heat loss
- C** Alumined reflector retains full heat intensity and directs more heat towards edges of holding surface
- D** Protective wire guard supports heating element without affecting heat distribution

Strip Heaters

**All Glo-Ray Narrow Infrared Models Feature:**  
**Toggle Switch (max. 15 Amps) with Indicator Light Location:** Chef's left side (unless otherwise specified).  
**Designer Color Angle Brackets:** To match unit color and provide 1½" clearance between strip heater and overshef. Non-standard colors are non-returnable.  
**Leads:** 6" leads – server's right. **Dimensions:** 18"-72"W x 4"D x 2"H.

**RECOMMENDED MOUNTING HEIGHTS – PAGE 101**  
**COLORS AND FINISHES – INSIDE BACK COVER**

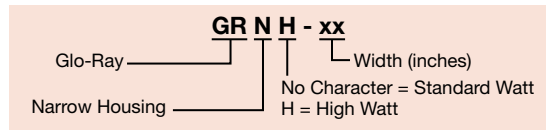

### OPTIONS (available at time of purchase only)

<b>Designer Colors, models 18"-72" – Non-standard colors are non-returnable – Black Standard –</b>	<b>No Charge</b>
<b>RED</b> Warm Red <b>WHITE</b> White Granite <b>GREEN</b> Hunter Green	
<b>GRAY</b> Gray Granite <b>NAVY</b> Navy Blue <b>COPPER</b> Antique Copper	
<b>Stainless Steel – Additional Charge – Non-standard colors are non-returnable –</b>	<b>per foot \$35</b>
<b>SS</b> Stainless Steel	
<b>Power Leads (must specify lead length) –</b>	
<b>LEADS5</b> 1'-5' extended Electrical Leads	<b>\$ 29</b>
<b>LEADS10</b> 6'-10' extended Electrical Leads	<b>58</b>
<b>LEADS15</b> 11'-15' extended Electrical Leads	<b>87</b>
<b>LEADS20</b> 16'-20' extended Electrical Leads	<b>116</b>
<b>NO CONTROL</b> No control included – Requires selection of RMB2-xx control – see page 103	<b>No Charge</b>
<b>RMB</b> Remote Control Enclosure (available in <i>Designer Colors</i> or <i>Gloss Finishes</i> ) – Non-standard colors are non-returnable –	<b>see pages 103 and 104</b>
<b>TABS</b> Stainless steel Hanger tabs in lieu of angle brackets	<b>No Charge</b>
<b>CAP</b> Attached 6' Cord and Plug Set (120V only) on models up to 72" with Standard Chain Mount Kit (two S Hooks with two 6" lengths of chain) and hanger tabs (max. 1800 Watt)	
<b>CHAIN-HOOK</b> Two S Hooks with two 6" lengths of chain	<b>each 15</b>
<b>NTL-10, -12</b> Non-Adjustable Tubular Stands (specify 10" or 12" clearance and power location)	<b>1 pair 122</b>
<b>NTL-14, -16</b> Non-Adjustable Tubular Stands (specify 14" or 16" clearance and power location)	<b>1 pair 131</b>
<b>NTL-PAINT</b> <i>Designer Color</i> for Non-Adjustable Tubular Stands to match unit color – Non-standard colors are non-returnable –	<b>1 pair 50</b>



## Glo-Ray® Narrow Max Watt Infrared Strip Heaters

Glo-Ray® Narrow Max Watt Infrared Strip Heaters keep all hot foods at optimum serving temperatures longer, while the slim design fits ideally in buffet areas. The entire holding surface is heated evenly with no “cold” spots.

- Slim design that's 2" high and 4" deep
- Available in widths from 18"-72"
- Pre-focused heat pattern maintains serving temperatures longer without continuing to cook the food
- Available in Stainless Steel only



**GRNM-24** in standard Stainless Steel with standard angle brackets

### GLO-RAY NARROW MAX WATT INFRARED STRIP HEATERS (must specify and add price of RMB)

Model	Width	Voltage (Single Phase)	Watts	Approx. Ship Weight	List Price <sup>o</sup>
GRNM-18	18"	120, 208 or 240	450	7 lbs.	\$ 507
GRNM-24	24"	120, 208 or 240	650	8 lbs.	548
GRNM-30	30"	120, 208 or 240	825	9 lbs.	592
GRNM-36	36"	120, 208 or 240	1000	10 lbs.	639
GRNM-42	42"	120, 208 or 240	1175	11 lbs.	689
GRNM-48	48"	120, 208 or 240	1300	13 lbs.	740
GRNM-54'	54"	120, 208 or 240	1500	13 lbs.	791
GRNM-60'	60"	120, 208 or 240	1700	13 lbs.	847
GRNM-66'	66"	120, 208 or 240	1875	16 lbs.	921
GRNM-72'	72"	120, 208 or 240	2075	16 lbs.	1035

<sup>o</sup> Does not include Remote Control Enclosure (RMB), see pages 103 and 104.

✓ Infinite Switch not available in 120V. RMB2-1R series Remote Control Enclosure (RMB) required for infinite control.

#### All Glo-Ray Narrow Max Watt Infrared Models Feature:

**Angle Brackets:** Provides 1½" clearance between strip heater and overshef.

**Leads:** 6" leads – server's right.

**Dimensions:** 18"-72"W x 4"D x 2"H.

#### RECOMMENDED MOUNTING HEIGHTS – PAGE 101

#### OPTIONS (available at time of purchase only)

##### Power Leads – Extended beyond Standard 6" Leads (must specify lead length) –

HTLEADS5	1'-5' extended Electrical Leads	\$ 41
HTLEADS10	6'-10' extended Electrical Leads	82
HTLEADS15	11'-15' extended Electrical Leads	123
HTLEADS20	16'-20' extended Electrical Leads	164
NO CONTROL	No control included – Requires selection of RMB2-xx control – see page 103	No Charge
RMB	Requires Remote Control Enclosure – Not available with Built-In controls	see pages 103 and 104
BLT INF	Infinite Control Built-In in lieu of Toggle (max. 12.2 Amps) (remote installation recommended)	each 51
NTL-14, -16	Non-Adjustable Tubular Stands (specify 14" or 16" clearance and power location)	1 pair 131

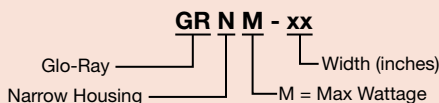

## Glo-Ray® Aluminum Infra-Black® High Watt Strip Heaters

For foodwarming at a close range to food product, the Glo-Ray® Infra-Black® heat technology is ideal, emitting a solid panel of uniform heat. Sturdy continuous single or dual extruded aluminum housings assure quality, durability and a variety of widths, depths, mounting arrangements and colors will fit your operation.

- Provides ideal amount of heat for limited space operations, mounted 4" to 10" above target surface for singles and 8" to 14" for duals
- Metal-sheathed heating element part guaranteed against burnout and breakage for two years
- Infra-Black emitter provides even heat distribution – eliminating hot spots
- Sturdy aluminum housings that do not sag, from 18" to 72" in 6" increments
- Heavy-duty insulation keeps the exterior housing cool
- Optional wire guard available to protect user from incidental contact with heated surface
- Optional 3" or 6" spacer available on dual models with or without lights (see next page)



**GRAIH-36** with optional wire guard, requires TCBI or Remote Control Enclosure (RMB)

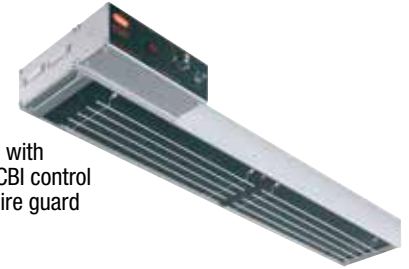

**GRAIH-36** with optional TCBI control box and wire guard

**Toggle Switch:** Max. 15 Amps  
**Infinite Switch:** Max. 12.2 Amps

### GLO-RAY ALUMINUM INFRA-BLACK HIGH WATT STRIP HEATERS (must specify and add price of RMB or TCBI)

Model	Width	Voltage Single Phase	Watts	Approx. Ship Weight <sup>o</sup>	List Price <sup>o</sup>
GRAIH-18	18"	120, 208 or 240	350	10 lbs.	\$ 576
GRAIH-24	24"	120, 208 or 240	500	11 lbs.	610
GRAIH-30	30"	120, 208 or 240	660	12 lbs.	649
GRAIH-36	36"	120, 208 or 240	800	13 lbs.	689
GRAIH-42	42"	120, 208 or 240	950	16 lbs.	730
GRAIH-48	48"	120, 208 or 240	1100	16 lbs.	772
GRAIH-54	54"	120, 208 or 240	1250	18 lbs.	813
GRAIH-60	60"	120, 208 or 240	1400	19 lbs.	866
GRAIH-66 <sup>f</sup>	66"	120, 208 or 240	1560	23 lbs.	936
GRAIH-72 <sup>f</sup>	72"	120, 208 or 240	1725	25 lbs.	1064

### GLO-RAY ALUMINUM INFRA-BLACK HIGH WATT STRIP HEATERS with LIGHTS (must specify and add price of RMB or TCBI)

Model	No. of Bulbs	Width	Voltage Single Phase	Watts	Approx. Ship Weight <sup>o</sup>	List Price <sup>o</sup>
GRAIHL-18	2	18"	120, 120/208 or 120/240	470	12 lbs.	\$ 775
GRAIHL-24	2	24"	120, 120/208 or 120/240	620	14 lbs.	816
GRAIHL-30	2	30"	120, 120/208 or 120/240	780	16 lbs.	897
GRAIHL-36	3	36"	120, 120/208 or 120/240	980	18 lbs.	983
GRAIHL-42	3	42"	120, 120/208 or 120/240	1130	20 lbs.	1072
GRAIHL-48	4	48"	120, 120/208 or 120/240	1340	22 lbs.	1161
GRAIHL-54	4	54"	120, 120/208 or 120/240	1490	24 lbs.	1248
GRAIHL-60	5	60"	120, 120/208 or 120/240	1700	26 lbs.	1361
GRAIHL-66 <sup>f</sup>	5	66"	120, 120/208 or 120/240	1860	28 lbs.	1488
GRAIHL-72 <sup>f</sup> <sup>o</sup>	6	72"	120, 120/208 or 120/240	2085	30 lbs.	1656

- <sup>o</sup> Does not include Remote Control Enclosure (RMB).
- <sup>o</sup> Does not include Remote Control Enclosure (RMB) or Thermostatic Control Box with Indicator Lights (TCBI). Must choose either RMB (see pages 103 and 104) or TCBI (see OPTIONS on page 92).
- <sup>f</sup> Infinite Switch not available in 120V.
- <sup>o</sup> 120V models available with remote control only.

#### All Glo-Ray Aluminum Infra-Black High Watt Models with or without Lights Feature:

Leads: 3' conduit with leads – server's right. 6" leads when supplied with TCBI – exit side of control box.

Dimensions: GRAIH: 18"-72"W x 6"D x 2 3/8"H.

GRAIHL: 18"-72"W x 9"D x 2 3/8"H.

TCBI Control Enclosure dimensions (not including switches): 8"W x 3"D x 2 1/2"H.

Control Enclosure location: Chef's left side – light side (unless otherwise specified).

#### OPTIONS AND ACCESSORIES – PAGE 92

#### RECOMMENDED MOUNTING HEIGHTS – PAGE 101

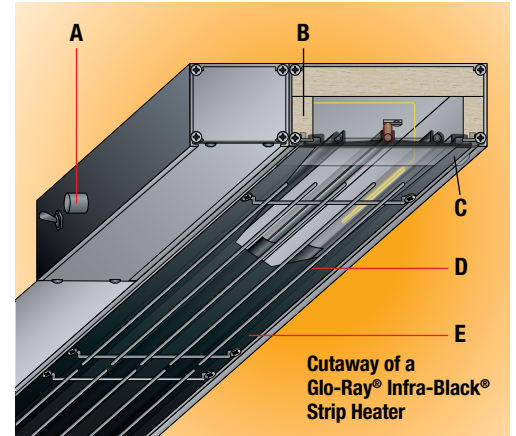

- A** Thermostatically controlled to regulate heat and provide consistent temperature. (Optional Remote Control Enclosure (RMB) available)
- B** Heavy-duty insulation minimizes heat loss
- C** Provides ideal amount of heat for limited space operations, effectively holding product
- D** Optional wire guard available to protect user from incidental contact with the heated surface
- E** Infra-Black emitter provides even heat distribution, eliminating hot spots for close applications

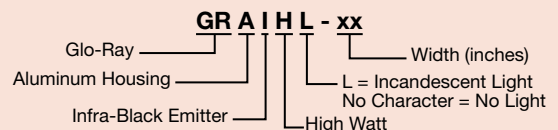

## Glo-Ray® Aluminum Infra-Black® High Watt Dual Strip Heaters



**GRAIH-60D** 120V models available with remote control only



**GRAIHL-24D** in optional Radiant Red Gloss Finish

**Toggle Switch:** Max. 15 Amps  
**Infinite Switch:** Max. 12.2 Amps

### GLO-RAY ALUMINUM INFRA-BLACK HIGH WATT DUAL STRIP HEATERS (must specify and add price of RMB or TCBI)

Model	Width	Voltage		Watts	Approx. Ship Weight <sup>o</sup>	List Price <sup>o</sup>	
		Single Phase				3" Spacer	6" Spacer
<b>GRAIH-18D</b>	18"	120, 208 or 240		700	16 lbs.	<b>\$1325</b>	<b>\$1340</b>
<b>GRAIH-24D</b>	24"	120, 208 or 240		1000	22 lbs.	<b>1403</b>	<b>1418</b>
<b>GRAIH-30D</b>	30"	120, 208 or 240		1320	22 lbs.	<b>1520</b>	<b>1541</b>
<b>GRAIH-36D</b>	36"	120, 208 or 240		1600	27 lbs.	<b>1639</b>	<b>1660</b>
<b>GRAIH-42D<sup>o</sup></b>	42"	120, 208 or 240		1900	35 lbs.	<b>1764</b>	<b>1785</b>
<b>GRAIH-48D<sup>o</sup></b>	48"	120, 208 or 240		2200	33 lbs.	<b>1889</b>	<b>1917</b>
<b>GRAIH-54D<sup>o</sup></b>	54"	120, 208 or 240		2500	41 lbs.	<b>2016</b>	<b>2044</b>
<b>GRAIH-60D<sup>o</sup></b>	60"	120, 208 or 240		2800	46 lbs.	<b>2181</b>	<b>2224</b>
<b>GRAIH-66D<sup>o</sup>/</b>	66"	120, 208 or 240		3120	44 lbs.	<b>2371</b>	<b>2414</b>
<b>GRAIH-72D<sup>o</sup>/</b>	72"	120, 208 or 240		3450	51 lbs.	<b>2656</b>	<b>2699</b>

### GLO-RAY ALUMINUM INFRA-BLACK HIGH WATT DUAL STRIP HEATERS with LIGHTS (must specify and add price of RMB or TCBI)

Model	No. of Bulbs	Width	Voltage		Watts	Approx. Ship Weight <sup>o</sup>	List Price <sup>o</sup>	
			Single Phase				3" Spacer	6" Spacer
<b>GRAIHL-18D</b>	2	18"	120, 120/208 or 120/240		820	15 lbs.	<b>\$1417</b>	<b>\$1432</b>
<b>GRAIHL-24D</b>	2	24"	120, 120/208 or 120/240		1120	21 lbs.	<b>1497</b>	<b>1512</b>
<b>GRAIHL-30D</b>	2	30"	120, 120/208 or 120/240		1440	25 lbs.	<b>1641</b>	<b>1662</b>
<b>GRAIHL-36D</b>	3	36"	120, 120/208 or 120/240		1780	29 lbs.	<b>1787</b>	<b>1808</b>
<b>GRAIHL-42D<sup>o</sup></b>	3	42"	120, 120/208 or 120/240		2080	33 lbs.	<b>1931</b>	<b>1952</b>
<b>GRAIHL-48D<sup>o</sup></b>	4	48"	120, 120/208 or 120/240		2440	35 lbs.	<b>2072</b>	<b>2100</b>
<b>GRAIHL-54D<sup>o</sup></b>	4	54"	120, 120/208 or 120/240		2740	39 lbs.	<b>2215</b>	<b>2243</b>
<b>GRAIHL-60D<sup>o</sup></b>	5	60"	120, 120/208 or 120/240		3100	47 lbs.	<b>2423</b>	<b>2466</b>
<b>GRAIHL-66D<sup>o</sup>/</b>	5	66"	120, 120/208 or 120/240		3420	47 lbs.	<b>2648</b>	<b>2691</b>
<b>GRAIHL-72D<sup>o</sup>/</b>	6	72"	120, 120/208 or 120/240		3810	54 lbs.	<b>2878</b>	<b>2921</b>

- <sup>o</sup> Does not include Remote Control Enclosure (RMB).
- <sup>o</sup> Does not include Remote Control Enclosure (RMB) or Thermostatic Control Box with Indicator Lights (TCBI).  
 Must choose either RMB (see pages 103 and 104) or TCBI (see OPTIONS on page 92).
- <sup>o</sup> 120V models available with remote control only.
- <sup>/</sup> Infinite Switch not available in 120V.
- <sup>o</sup> TCBI not available in 208V, 120/208V.

**All Glo-Ray Aluminum Infra-Black High Watt Dual Models with or without Lights Feature:**

**Leads:** 3' conduit with leads – server's right. 6" leads when supplied with TCBI – exit side of control box.

**Dimensions:** GRAIH-xxD with 3" Spacer: 18"-72"W x 15"D x 2 3/8"H.  
 GRAIHL-xxD with 3" Spacer: 18"-66"W x 15"D x 2 3/8"H.  
 GRAIH-xxD with 6" Spacer: 18"-72"W x 18"D x 2 3/8"H.  
 GRAIHL-xxD with 6" Spacer: 18"-66"W x 18"D x 2 3/8"H.

**TCBI Control Enclosure dimensions (not including switches):** 8"W x 3"D x 2 1/2"H.  
**Control Enclosure location:** Chef's left side – light side (unless otherwise specified).

**OPTIONS AND ACCESSORIES – PAGE 92**  
**RECOMMENDED MOUNTING HEIGHTS – PAGE 101**

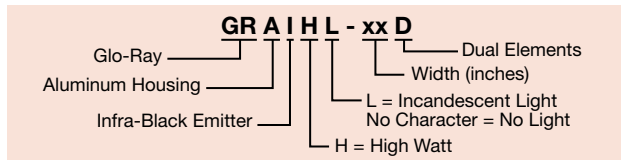

Strip Heaters



**GRAIH-72** with optional wire guard, requires Remote Control Enclosure (RMB)

**OPTIONS** (available at time of purchase only)

**Designer Colors – Non-standard colors are non-returnable – Clear Anodized Standard –**

<b>COLOR-6, -9</b>	6" Housing for GRAIH models and 9" Housing for GRAIHL models	<b>RED</b> Warm Red	<b>GRAY</b> Gray Granite	<b>NAVY</b> Navy Blue	<b>COPPER</b> Antique Copper	per foot	\$35
		<b>BLACK</b> Black	<b>WHITE</b> White Granite	<b>GREEN</b> Hunter Green			
<b>COLOR-15, -18</b>	15" and 18" Housings for GRAIH and GRAIHL Dual models	<b>RED</b> Warm Red	<b>GRAY</b> Gray Granite	<b>NAVY</b> Navy Blue	<b>COPPER</b> Antique Copper	per foot	50
		<b>BLACK</b> Black	<b>WHITE</b> White Granite	<b>GREEN</b> Hunter Green			

**Gloss Finishes – Non-standard colors are non-returnable – Clear Anodized Standard –**

<b>GLOSS-6, -9</b>	6" Housing for GRAIH models and 9" Housing for GRAIHL models	<b>RRED</b> Radiant Red	<b>GGRAY</b> Glossy Gray	<b>BBLACK</b> Bold Black		per foot	\$48
		<b>GGOLD</b> Gleaming Gold	<b>BBLUE</b> Brilliant Blue				
<b>GLOSS-15, -18</b>	15" and 18" Housings for GRAIH and GRAIHL Dual models	<b>RRED</b> Radiant Red	<b>GGRAY</b> Glossy Gray	<b>BBLACK</b> Bold Black		per foot	64
		<b>GGOLD</b> Gleaming Gold	<b>BBLUE</b> Brilliant Blue				

<b>AIH18WG -AIH72WG</b>	Element Wire Guard (Dual models require two sets)	per foot (per side)	\$36
<b>HAL</b>	60 Watt Halogen Bulb in lieu of Standard Display Light	each	69
<b>NO CONTROL</b>	No control included (GRAIH, GRAIHL-xx, GRAIH, GRAIHL-xxD models only) Requires selection of RMB2-xx control – see page 103		No Charge

<b>RMB</b>	Remote Control Enclosure – available in <i>Designer Colors</i> or <i>Gloss Finishes</i> – Non-standard colors are non-returnable – <b>Clear Anodized Standard –</b>	see pages 103 and 104		
	<b>RED</b> Warm Red	<b>GRAY</b> Gray Granite	<b>NAVY</b> Navy Blue	<b>COPPER</b> Antique Copper
	<b>BLACK</b> Black	<b>WHITE</b> White Granite	<b>GREEN</b> Hunter Green	
	<b>RRED</b> Radiant Red	<b>GGRAY</b> Glossy Gray	<b>BBLACK</b> Bold Black	
	<b>GGOLD</b> Gleaming Gold	<b>BBLUE</b> Brilliant Blue		

<b>TCBI</b>	Thermostatic Control Box with Indicator Lights		\$237
-------------	--	--	-------

**Non-Adjustable Tubular Stands**

<b>AIH4NTL</b>	4"	1 pair	122
<b>AIH6NTL</b>	6"	1 pair	122
<b>AIH7.5NTL-D</b>	7.5"	2 pair	244
<b>AIH8NTL</b>	8" (Dual models require two pair)	1 pair	122
<b>AIH10NTL</b>	10" (Dual models require two pair)	1 pair	122
<b>AIH12NTL-D</b>	12"	2 pair	244
<b>AIH14NTL-D</b>	14"	2 pair	262

<b>NTL-PAINT</b>	<i>Designer Color</i> or <i>Gloss Finish</i> for Non-Adjustable Tubular Stands to match unit color – Non-Standard colors are non-returnable –	1 pair	50
<b>NTL-PAINT-D</b>	<i>Designer Color</i> or <i>Gloss Finish</i> for Non-Adjustable Tubular Stands to match unit color – Non-Standard colors are non-returnable –	2 pair	100

**Power Leads (must specify lead length) –**

<b>HTLEADS5</b>	1'-5' extended Electrical Leads	\$	41
<b>HTLEADS10</b>	6'-10' extended Electrical Leads		82
<b>HTLEADS15</b>	11'-15' extended Electrical Leads		123
<b>HTLEADS20</b>	16'-20' extended Electrical Leads		164

**ACCESSORIES** (available for purchase at any time)

<b>ADJ ANGLE</b>	Adjustable Angle Brackets (see page 102 for illustration)	1 pair	\$ 31
<b>ADJ ANGLE7</b>	7" tall Adjustable Angle Brackets (see page 102 for illustration)	1 pair	37
<b>ADJ ANGLE-D</b>	Adjustable Angle Brackets for Dual models (see page 102 for illustration)	2 pair	62
<b>ADJ ANGLE7-D</b>	7" tall Adjustable Angle Brackets for Dual models (see page 102 for illustration)	2 pair	74
<b>CHAIN 1</b>	Chain Suspension (see page 102 for illustration)	per foot	15

**Chef LED 120V adjustable bulb – GRAIHL-xx models only, all voltages – pass-through usage only –**

	GRAIHL-xx must be 11" or higher from surface as pass through – bulbs must be rotated down –		
<b>CLED-3000-120</b>	Similar to warm Halogen light	<b>CLED-4000-120</b>	Similar to cool Fluorescent light
		each	139

**COLORS AND FINISHES – INSIDE BACK COVER**



## Glo-Ray® Designer Aluminum Infrared Strip Heaters

Hatco Glo-Ray Designer Aluminum Infrared Strip Heaters safely keep all hot foods at optimum serving temperatures longer. This modern design is ideal for front-of-the-house use. Units are offered in continuous housings, up to 84" (7'), are available in Designer Colors to match most décors and include 14" Designer non-adjustable stands.

- Pre-focused heat maintains safe serving temperatures longer without continuing to cook the food
- Available in widths from 21½" to 87½"
- Available in a variety of models, configurations, colors and accessories to provide unlimited flexibility
- Black corner caps and inset panels standard
- Optional coated shatter-resistant incandescent or halogen lights enhance product displays while safeguarding food from bulb breakage
- Optional Sneeze Guards
- Additional reflector styles and lower wattage elements available, consult factory for more information



GR2AH-36 with Designer non-adjustable stands (NTL) and optional Designer Warm Red inset panels



GR2AHL-36 with optional overhead mounts (NTH) and optional Designer Warm Red inset panels

**Toggle Switch:** Max. 15 Amps  
**Infinite Switch:** Max. 12.2 Amps

### GLO-RAY DESIGNER ALUMINUM INFRARED STRIP HEATERS (must specify and add price of RMB)

Model <sup>Ⓢ</sup>	Width	Watts	Approx. Ship Weight <sup>Ⓞ</sup>	List Price <sup>Ⓞ</sup>
<b>Standard Watt</b>				
GR2A-18	21½"	250	19 lbs.	\$1410
GR2A-24	27½"	350	20 lbs.	1466
GR2A-30	33½"	450	27 lbs.	1525
GR2A-36	39½"	575	37 lbs.	1583
GR2A-42	45½"	675	38 lbs.	1644
GR2A-48	51½"	800	43 lbs.	1703
GR2A-54	57½"	925	43 lbs.	1767
GR2A-60	63½"	1050	40 lbs.	1848
GR2A-66	69½"	1160	40 lbs.	1931
GR2A-72	75½"	1275	42 lbs.	2050
GR2A-84'	87½"	1500	46 lbs.	2371
<b>High Watt</b>				
GR2AH-18	21½"	350	20 lbs.	\$1418
GR2AH-24	27½"	500	20 lbs.	1474
GR2AH-30	33½"	660	27 lbs.	1533
GR2AH-36	39½"	800	27 lbs.	1591
GR2AH-42	45½"	950	34 lbs.	1652
GR2AH-48	51½"	1100	27 lbs.	1711
GR2AH-54	57½"	1250	43 lbs.	1775
GR2AH-60	63½"	1400	40 lbs.	1856
GR2AH-66'	69½"	1560	40 lbs.	1939
GR2AH-72'	75½"	1725	42 lbs.	2058
GR2AH-84'	87½"	2050	46 lbs.	2379

- Ⓢ When no color is specified, color inset panels and corner caps will be black.
- Ⓞ Does not include Remote Control Enclosure (RMB).
- Ⓞ Does not include Remote Control Enclosure (RMB). Must choose RMB (see pages 103 and 104).
- ⚡ When using an infinite control with 120 volt model, additional switch(es) and tandem (end-to-end) elements required.
- ⚡ 120 volt models require additional switches and tandem (end-to-end) elements.

**All Glo-Ray Designer Aluminum Infrared Models Feature:**

**Voltage:** 120, 208 or 240, single phase only.  
**Switch Location:** Remote Control Enclosure (RMB) only (see pages 103 and 104).  
**Leads:** 5' leads through ½" conduit in leg cavity.  
**Dimensions without stands:** 21½"-87½"W x 9"D x 3½"H.

**OPTIONS AND ACCESSORIES – PAGE 95**  
**RECOMMENDED MOUNTING HEIGHTS – PAGE 101**

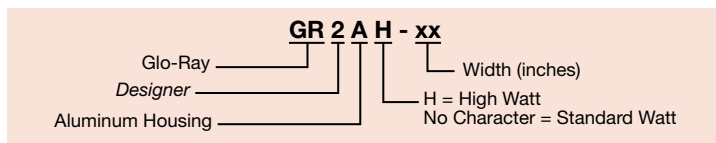

Strip Heaters



## Glo-Ray® Designer Aluminum Infrared Strip Heaters with Lights



**GR2AHL-24** with Designer non-adjustable stands optional Sneeze Guards and Designer Hunter Green inset panels

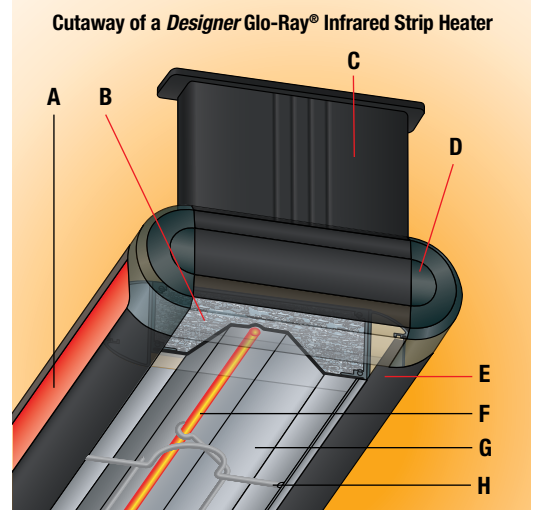

- A** Choice of seven Designer Color inset panels and attractive styling for front-of-the-house applications
- B** Heavy-duty insulation minimizes heat loss
- C** Non-adjustable stand conceals the power wiring, available for counter or overhead mounting
- D** Accent color corners available in Dark Gray or Black (standard)
- E** Sturdy aluminium extrusion construction; available in Clear Anodized aluminum finish or one of seven Designer Colors for housings (shown in optional Designer Black)
- F** Metal-sheathed heating element part guaranteed against burnout and breakage for two years
- G** Aluminized Reflectors won't discolor, so heat can be reflected and directed to the food product being held
- H** Protective wire guard supports heating element without affecting heat distribution

### GLO-RAY DESIGNER ALUMINUM INFRARED STRIP HEATERS with LIGHTS (must specify and add price of RMB)

Model <sup>®</sup>	No. of Bulbs	Width	Watts	Approx. Ship Weight <sup>○</sup>	List Price <sup>°</sup>
<b>Standard Watt</b>					
GR2AL-18	2	21½"	370	24 lbs.	<b>\$1606</b>
GR2AL-24	2	27½"	470	24 lbs.	<b>1670</b>
GR2AL-30	2	33½"	570	29 lbs.	<b>1766</b>
GR2AL-36	3	39½"	755	33 lbs.	<b>1872</b>
GR2AL-42	3	45½"	855	35 lbs.	<b>1981</b>
GR2AL-48	4	51½"	1040	36 lbs.	<b>2093</b>
GR2AL-54	4	57½"	1165	49 lbs.	<b>2208</b>
GR2AL-60	5	63½"	1350	54 lbs.	<b>2327</b>
GR2AL-66	5	69½"	1460	57 lbs.	<b>2457</b>
GR2AL-72	6	75½"	1635	58 lbs.	<b>2619</b>
GR2AL-84	7	87½"	1920	62 lbs.	<b>2833</b>
<b>High Watt</b>					
GR2AHL-18	2	21½"	470	26 lbs.	<b>\$1614</b>
GR2AHL-24	2	27½"	620	24 lbs.	<b>1678</b>
GR2AHL-30	2	33½"	780	29 lbs.	<b>1774</b>
GR2AHL-36	3	39½"	980	33 lbs.	<b>1880</b>
GR2AHL-42	3	45½"	1130	35 lbs.	<b>1989</b>
GR2AHL-48	4	51½"	1340	48 lbs.	<b>2101</b>
GR2AHL-54	4	57½"	1490	49 lbs.	<b>2216</b>
GR2AHL-60	5	63½"	1700	54 lbs.	<b>2335</b>
GR2AHL-66	5	69½"	1860	57 lbs.	<b>2465</b>
GR2AHL-72	6	75½"	2085	58 lbs.	<b>2627</b>
GR2AHL-84	7	87½"	2470	62 lbs.	<b>2841</b>

- ® When no color is specified, color inset panels and corner caps will be black.
- Does not include Remote Control Enclosure (RMB).
- ° Does not include Remote Control Enclosure (RMB). Must choose RMB (see pages 103 and 104).
- ⚡ When using an infinite control with 120 volt model, additional switch(es) and tandem (end-to-end) elements required.
- ⚡ 120 volt models require additional switches and tandem (end-to-end) elements.

#### All Glo-Ray Designer Aluminum Infrared Models with Lights Feature:

**Voltage:** 120, 120/208 or 120/240, single phase only.

**Switch Location:** Remote Control Enclosure (RMB) only (see pages 103 and 104).

**Leads:** 5' leads through ½" conduit in leg cavity.

**Dimensions without stands:** 21½"-87½"W x 12"D x 3½"H.

#### OPTIONS AND ACCESSORIES – PAGE 95

#### RECOMMENDED MOUNTING HEIGHTS – PAGE 101

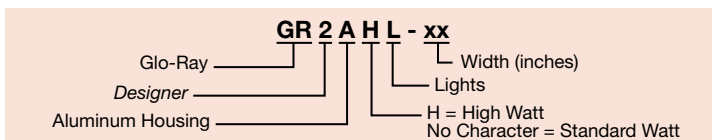



**GR2AHL-84** with standard *Designer* non-adjustable stands and optional *Designer* Black and Sneeze Guards

Strip Heaters

**OPTIONS** (available at time of purchase only)

**Designer Colors, aluminum models 21½" - 87½" (includes stands) – Non-standard colors are non-returnable – Clear Anodized Standard –**

<b>COLOR-6</b>	9" Housing for GR2A and GR2AH models						<b>per foot \$35</b>
	<b>RED</b>	Warm Red	<b>GRAY</b>	Gray Granite	<b>NAVY</b>	Navy Blue	<b>COPPER</b> Antique Copper
	<b>BLACK</b>	Black	<b>WHITE</b>	White Granite	<b>GREEN</b>	Hunter Green	
<b>COLOR-9</b>	12" Housing for GR2AL and GR2AHL models						<b>per foot 35</b>
	<b>RED</b>	Warm Red	<b>GRAY</b>	Gray Granite	<b>NAVY</b>	Navy Blue	<b>COPPER</b> Antique Copper
	<b>BLACK</b>	Black	<b>WHITE</b>	White Granite	<b>GREEN</b>	Hunter Green	
<b>Designer Inset Panel Colors – Black standard – Non-standard colors are non-returnable –</b>							<b>No Charge</b>
	<b>RED</b>	Warm Red	<b>WHITE</b>	White Granite	<b>GREEN</b>	Hunter Green	
	<b>GRAY</b>	Gray Granite	<b>NAVY</b>	Navy Blue	<b>COPPER</b>	Antique Copper	
<b>Designer Corner Caps – Black standard –</b>							<b>No Charge</b>
	<b>DKGRAY</b>	Dark Gray Corner Caps					<b>No Charge</b>
<b>NO CONTROL</b>	No control included (GR2A, GR2AH, GR2AL, GR2AHL models only), requires selection of RMB2-xx control – see page 103						<b>No Charge</b>
<b>RMB</b>	Must choose Remote Control Enclosure (not included)						<b>see pages 103 and 104</b>
<b>Designer Remote Control Enclosures – Non-standard colors are non-returnable – Clear Anodized Standard –</b>							<b>\$50</b>
<b>RMB-COLOR</b>	Remote Control Enclosure Housing in <i>Designer</i> Color						
	<b>RED</b>	Warm Red	<b>GRAY</b>	Gray Granite	<b>NAVY</b>	Navy Blue	<b>COPPER</b> Antique Copper
	<b>BLACK</b>	Black	<b>WHITE</b>	White Granite	<b>GREEN</b>	Hunter Green	
<b>7.5BP1</b>	7½" Sneeze Guard one side						<b>per foot \$ 77</b>
<b>7.5BP2</b>	7½" Sneeze Guard two sides						<b>per foot 154</b>
<b>14BP1</b>	14" Sneeze Guard one side						<b>per foot 122</b>
<b>14BP2</b>	14" Sneeze Guard two sides						<b>per foot 244</b>
<b>NTL2-10, -12, -16</b>	<i>Designer</i> Color Non-Adjustable Stands to match unit color: 10", 12" or 16" in lieu of 14" Standard Stands – Non-Standard colors are non-returnable –						<b>No Charge</b>
<b>NTH2-4</b>	4" <i>Designer</i> Color Overhead Mounts in lieu of 14" Standard Legs to match unit color – Non-Standard colors are non-returnable –						<b>No Charge</b>
<b>HAL</b>	60 Watt Halogen Bulb in lieu of standard Display Light						<b>each 69</b>
<b>NO BULB</b>	No bulb option (GR2AL, GR2AHL models only)						<b>No Charge</b>
<b>LIGHTS-ADD'L</b>	Extra Lamps – Installed (max. two per ft. less one – one per ft. is Standard)						<b>each 35</b>
<b>Power Leads (must specify lead length) –</b>							
<b>LEADS5</b>	1'-5' extended Electrical Leads						<b>\$29</b>
<b>LEADS10</b>	6'-10' extended Electrical Leads						<b>58</b>
<b>LEADS15</b>	11'-15' extended Electrical Leads						<b>87</b>
<b>LEADS20</b>	16'-20' extended Electrical Leads						<b>116</b>

**ACCESSORIES** (available for purchase at any time)

**Chef LED 120V adjustable bulb – GR2AL, GR2AHL models only, all voltages –**

GR2AHL requires pass-through usage only and unit must be 10" or higher from surface – bulbs must be rotated down

**CLED-3000-120** Similar to warm Halogen light **CLED-4000-120** Similar to cool Fluorescent light

**each \$139**

**COLORS AND FINISHES – INSIDE BACK COVER**

**CLED-3000 and -4000**  
Accessory



## Glo-Ray® Designer Aluminum Infrared Dual Strip Heaters

Glo-Ray Designer Aluminum Infrared Dual Strip Heaters allow side-by-side mounting of two warmers to provide a deeper holding area, keeping hot food at optimum serving temperatures. These modern front-of-the-house warmers have 3" spacers standard with optional 6" spacers. Units are available in Designer colors to match most décors.

- Sturdy continuous aluminum housings eliminate sagging
- Pre-focused heat pattern directs heat from a tubular element to bathe the entire holding surface, holding food safely
- Available in widths from 21½" to 87½"
- Variety of models, configurations, colors and accessories provide unlimited flexibility. Non-standard colors are non-returnable
- Optional Sneeze Guards that meet food safety standards can be ordered for display areas and buffet lines
- Optional shatter-resistant incandescent lights available
- Black corner caps and inset panels standard
- Additional reflector styles and lower wattage elements available, consult factory for more information



**GR2AH-24D** with standard Designer non-adjustable stands, optional Sneeze Guards and optional Designer Navy Blue inset panels



**GR2AHL-48D** with standard Designer non-adjustable stands and optional Designer Warm Red inset panels

**Toggle Switch:** Max. 15 Amps  
**Infinite Switch:** Max. 12.2 Amps

### GLO-RAY DESIGNER ALUMINUM INFRARED DUAL STRIP HEATERS (must specify and add price of RMB)

Model <sup>®</sup>	Width	Watts	Approx. Ship Weight <sup>○</sup>	List Price <sup>○</sup>	
				3" Spacer	6" Spacer
<b>Standard Watt</b>					
GR2A-18D	21½"	500	28 lbs.	\$2040	\$2055
GR2A-24D	27½"	700	31 lbs.	2120	2135
GR2A-30D	33½"	900	37 lbs.	2241	2262
GR2A-36D	39½"	1150	37 lbs.	2366	2387
GR2A-42D	45½"	1350	41 lbs.	2494	2515
GR2A-48D	51½"	1600	45 lbs.	2620	2648
GR2A-54D	57½"	1850	52 lbs.	2749	2777
GR2A-60D	63½"	2100	60 lbs.	2912	2940
GR2A-66D	69½"	2320	70 lbs.	3077	3120
GR2A-72D	75½"	2550	63 lbs.	3322	3365
GR2A-84D	87½"	3000	84 lbs.	3612	3670
<b>High Watt</b>					
GR2AH-18D	21½"	700	29 lbs.	\$2056	\$2071
GR2AH-24D	27½"	1000	29 lbs.	2136	2151
GR2AH-30D	33½"	1320	37 lbs.	2257	2278
GR2AH-36D	39½"	1600	37 lbs.	2382	2403
GR2AH-42D	45½"	1900	48 lbs.	2510	2531
GR2AH-48D	51½"	2200	55 lbs.	2636	2664
GR2AH-54D	57½"	2500	60 lbs.	2765	2793
GR2AH-60D	63½"	2800	55 lbs.	2928	2971
GR2AH-66D	69½"	3120	64 lbs.	3093	3136
GR2AH-72D	75½"	3450	61 lbs.	3338	3381
GR2AH-84D	87½"	4100	106 lbs.	3628	3686

- ® When no color is specified, color inset panels and corner caps will be black.
- Does not include Remote Control Enclosure (RMB).
- Does not include Remote Control Enclosure (RMB). Must choose RMB, see pages 103, 104.
- ∞ Infinite switch requires tandem for 120 volt GR2AH-66D & -72D.
- ∞ 120 volt requires tandem for GR2AH-84D.

**All Glo-Ray Designer Aluminum Infrared Dual Models Feature:**  
**Voltage:** Models Without Lights: 120, 208 or 240, single phase only.  
**Switch Location:** Remote Control Enclosure (RMB) only (see pages 103, 104).  
**Leads:** 5' leads through ½" conduit in leg cavity.  
**Dimensions:** with 3" Spacer (standard): 21½"-87½"W x 18"D x 3½"H.  
with 6" Spacer: 21½"-87½"W x 21"D x 3½"H.

**OPTIONS AND ACCESSORIES – PAGE 97**  
**RECOMMENDED MOUNTING HEIGHTS – PAGE 101**

### GLO-RAY DESIGNER ALUMINUM INFRARED DUAL STRIP HEATERS with LIGHTS (must specify and add price of RMB)

Model <sup>®</sup>	No. of Bulbs	Width	Watts	Approx. Ship Weight <sup>○</sup>	List Price <sup>○</sup>	
					3" Spacer	6" Spacer
<b>Standard Watt</b>						
GR2AL-18D	2	21½"	620	32 lbs.	\$2137	\$2152
GR2AL-24D	2	27½"	820	32 lbs.	2218	2233
GR2AL-30D	2	33½"	1020	35 lbs.	2359	2380
GR2AL-36D	3	39½"	1330	40 lbs.	2512	2533
GR2AL-42D	3	45½"	1530	46 lbs.	2657	2678
GR2AL-48D	4	51½"	1840	47 lbs.	2807	2835
GR2AL-54D	4	57½"	2090	50 lbs.	2958	2986
GR2AL-60D	5	63½"	2400	55 lbs.	3155	3198
GR2AL-66D	5	69½"	2620	67 lbs.	3356	3399
GR2AL-72D	6	75½"	2910	75 lbs.	3628	3671
GR2AL-84D	7	87½"	3420	82 lbs.	3990	4048
<b>High Watt</b>						
GR2AHL-18D	2	21½"	820	32 lbs.	\$2153	\$2168
GR2AHL-24D	2	27½"	1120	32 lbs.	2234	2249
GR2AHL-30D	2	33½"	1440	35 lbs.	2375	2396
GR2AHL-36D	3	39½"	1780	40 lbs.	2528	2549
GR2AHL-42D	3	45½"	2080	46 lbs.	2673	2694
GR2AHL-48D	4	51½"	2440	47 lbs.	2823	2851
GR2AHL-54D	4	57½"	2740	50 lbs.	2974	3002
GR2AHL-60D	5	63½"	3100	55 lbs.	3171	3214
GR2AHL-66D	5	69½"	3420	67 lbs.	3372	3415
GR2AHL-72D	6	75½"	3810	75 lbs.	3644	3687
GR2AHL-84D	7	87½"	4520	82 lbs.	4006	4064

- ® When no color is specified, color inset panels and corner caps will be black.
- Does not include Remote Control Enclosure (RMB).
- Does not include Remote Control Enclosure (RMB). Must choose RMB, see pages 103, 104.
- ∞ Infinite switch requires tandem for 120 volt GR2AH-66D & -72D.
- ∞ 120 volt requires tandem for GR2AH-84D.

**All Glo-Ray Designer Aluminum Infrared Dual with Lights Models Feature:**  
**Voltage:** Models With Lights: 120, 120/208 or 120/240, single phase only.  
**Switch Location:** Remote Control Enclosure (RMB) only (see pages 103, 104).  
**Leads:** 5' leads through ½" conduit in leg cavity.  
**Dimensions:** with 3" Spacer (standard): 21½"-87½"W x 18"D x 3½"H.  
with 6" Spacer: 21½"-87½"W x 21"D x 3½"H.

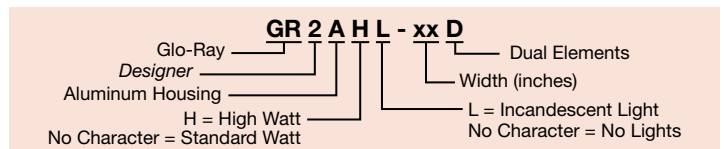





GR2AHL-30D

**OPTIONS** (available at time of purchase only)

**Designer Colors, aluminum models 21½"- 87½" (includes stands) – Non-standard colors are non-returnable – Clear Anodized standard –**

<b>COLOR-15, -18</b>	15" and 18" Housings for GR2A, GR2AH, GR2AL and GR2AHL Dual models						per foot	\$50
<b>RED</b>	Warm Red	<b>GRAY</b>	Gray Granite	<b>NAVY</b>	Navy Blue	<b>COPPER</b>	Antique Copper	
<b>BLACK</b>	Black	<b>WHITE</b>	White Granite	<b>GREEN</b>	Hunter Green			

**Designer Inset Panel Colors – Black standard –**

<b>RED</b>	Warm Red	<b>WHITE</b>	White Granite	<b>GREEN</b>	Hunter Green		No Charge
<b>GRAY</b>	Gray Granite	<b>NAVY</b>	Navy Blue	<b>COPPER</b>	Antique Copper		

**Designer Corner Caps – Black standard –**

<b>DKGRAY</b>	Dark Gray Corner Caps						No Charge
---------------	-----------------------	--	--	--	--	--	-----------

**NO CONTROLS** No control included (GR2A, GR2AH, GR2AL, GR2AHL-xxD models only), requires selection of RMB2-xx control – see page 103 **No Charge**

**RMB** Remote Control Enclosure – available in *Designer Colors* or *Gloss Finishes* – Non-standard colors are non-returnable – Clear Anodized standard – (must choose a Remote Control Enclosure - not included) **see pages 103 and 104**

<b>RED</b>	Warm Red	<b>GRAY</b>	Gray Granite	<b>NAVY</b>	Navy Blue	<b>COPPER</b>	Antique Copper
<b>BLACK</b>	Black	<b>WHITE</b>	White Granite	<b>GREEN</b>	Hunter Green		
<b>RRED</b>	Radiant Red	<b>GGRAY</b>	Glossy Gray	<b>BBLACK</b>	Bold Black		
<b>GGOLD</b>	Gleaming Gold	<b>BBLUE</b>	Brilliant Blue				

<b>7.5BP1</b>	7½" Sneeze Guard one side						per foot	\$ 77
<b>7.5BP2</b>	7½" Sneeze Guard two sides						per foot	154
<b>14BP1</b>	14" Sneeze Guard one side						per foot	122
<b>14BP2</b>	14" Sneeze Guard two sides						per foot	244

**NTL2-10, -12, -16** *Designer* Non-Adjustable Stands: 10", 12" or 16" in lieu of 14" Standard Stands to match unit color – Non-Standard colors are non-returnable – **No Charge**

**NTH2-4** 4" *Designer* Overhead Mounts in lieu of 14" Standard Stands to match unit color – Non-Standard colors are non-returnable – **No Charge**

**HAL** 60 Watt Halogen Bulb in lieu of Standard Display Light **each \$69**

**NO BULB** No bulb option (GR2AL-xxD, GR2AHL-xxD models only) **No Charge**

**LIGHTS-ADD'L** Extra Lamps – Installed (max. two per ft. less one – one per ft. is Standard) **each 35**

**Power Leads (must specify lead length) –**

<b>LEADS5</b>	1'-5' extended Electrical Leads	\$29
<b>LEADS10</b>	6'-10' extended Electrical Leads	58
<b>LEADS15</b>	11'-15' extended Electrical Leads	87
<b>LEADS20</b>	16'-20' extended Electrical Leads	116

**ACCESSORIES** (available for purchase at any time)

**Chef LED 120V adjustable bulb – GR2AL-xxD, GR2AHL-xxD models only, all voltages –**

GR2AL-xxD requires pass-through usage only and unit must be 15" or higher from surface

GR2AHL-xxD requires pass-through usage only and unit must be 18" or higher from surface

Bulbs must be rotated down –

<b>CLED-3000-120</b>	Similar to warm Halogen light	<b>CLED-4000-120</b>	Similar to cool Fluorescent light	each	\$139
----------------------	-------------------------------	----------------------	-----------------------------------	------	-------

**COLORS AND FINISHES – INSIDE BACK COVER**

Strip Heaters

## Ultra-Glo® Aluminum Ceramic Infrared Strip Heaters

Hatco Ultra-Glo Aluminum Ceramic Infrared Strip Heaters provide the ultimate holding power. Increased heights improve working clearances and the heat zone blankets the entire holding area. All models include adjustable angle brackets for mounting. Available with or without lights, with Attached or Remote Control Enclosure (recommended).



**UGAH-18** in optional Gloss Finish, requires Remote Control Enclosure (RMB), not shown

- Pre-focused pyramidal heat pattern concentrates the heat at the edges where heat loss is greatest
- Increased height that the ceramic heat source affords improves operational working clearances, giving the chef and server an improved ergonomic environment in which to work
- Adaptable to many locations and configurations, including back- or front-of-the-house use, open kitchen concepts or buffet lines
- Available in widths from 18" to 72" in 6" increments
- Optional coated shatter-resistant incandescent or halogen bulbs enhance product display while safeguarding food from bulb breakage

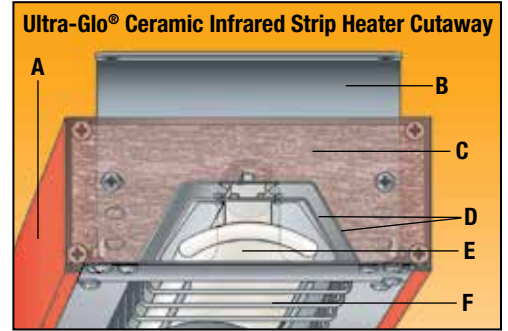

- A** Sturdy aluminum housings that do not sag
- B** Adjustable standard mounting bracket (allows 3 different mounting heights and allows for conduit connection to end of the unit)
- C** Heavy-duty insulation surrounds heating element to keep exterior housing cooler and minimize heat loss
- D** Dual aluminized steel reflector keeps housing cooler, focuses more heat towards the food
- E** Shape of element focuses heat on the food
- F** Protective wire guards under heating element

Strip Heaters

### ULTRA-GLO ALUMINUM CERAMIC INFRARED STRIP HEATERS

Model	Width	Voltage Single Phase	Watts	Approx. Ship Weight <sup>o</sup>	List Price <sup>o</sup>
<b>Standard Watt</b>					
<b>UGA-18</b>	18"	120, 208 or 240	500, 490 or 500	9 lbs.	<b>\$ 847</b>
<b>UGA-24</b>	24"	120, 208 or 240	650, 675 or 650	10 lbs.	<b>859</b>
<b>UGA-30</b>	30"	120, 208 or 240	750, 840 or 900	14 lbs.	<b>1034</b>
<b>UGA-36</b>	36"	120, 208 or 240	1000, 980 or 1000	15 lbs.	<b>1045</b>
<b>UGA-42</b>	42"	120, 208 or 240	1000, 1120 or 1200	17 lbs.	<b>1217</b>
<b>UGA-48</b>	48"	120, 208 or 240	1500, 1470 or 1500	19 lbs.	<b>1229</b>
<b>UGA-54</b>	54"	208 or 240	1470 or 1500	20 lbs.	<b>1392</b>
<b>UGA-60</b>	60"	208 or 240	1960 or 2000	22 lbs.	<b>1405</b>
<b>UGA-66</b>	66"	208 or 240	1960 or 2000	25 lbs.	<b>1571</b>
<b>UGA-72</b>	72"	208 or 240	1960 or 2000	25 lbs.	<b>1607</b>
<b>High Watt</b>					
<b>UGAH-18</b>	18"	120, 208 or 240	650, 675 or 650	10 lbs.	<b>\$ 855</b>
<b>UGAH-24</b>	24"	120, 208 or 240	750, 750 or 750	9 lbs.	<b>867</b>
<b>UGAH-30</b>	30"	120, 208 or 240	1125, 1125 or 1125	12 lbs.	<b>1042</b>
<b>UGAH-36</b>	36"	120, 208 or 240	1300, 1350 or 1300	15 lbs.	<b>1053</b>
<b>UGAH-42</b>	42"	120, 208 or 240	1500, 1500 or 1500	16 lbs.	<b>1225</b>
<b>UGAH-48</b>	48"	208 or 240	2025 or 1950	19 lbs.	<b>1237</b>
<b>UGAH-54</b>	54"	208 or 240	2250 or 2250	20 lbs.	<b>1400</b>
<b>UGAH-60</b>	60"	208 or 240	2700 or 2600	24 lbs.	<b>1413</b>
<b>UGAH-66</b>	66"	208 or 240	2700 or 2600	23 lbs.	<b>1579</b>
<b>UGAH-72</b>	72"	208 or 240	3000 or 3000	25 lbs.	<b>1615</b>

**All Ultra-Glo Aluminum Ceramic Infrared Models Feature:**  
**Models Shipped With:** Angle Brackets and Leads (3' conduit whip).  
**Dimensions With Attached Control Box, Toggle and Indicator Light:** 18"-72"W x 9 7/8"D x 2 1/2"H.  
**Dimensions With Remote Control Enclosure (RMB), Toggle and Indicator Light:** 18"-72"W x 6"D x 2 1/2"H.

**OPTIONS – PAGE 100**  
**RECOMMENDED MOUNTING HEIGHTS – PAGE 101**  
**REMOTE CONTROL ENCLOSURES (RMB) – PAGE 104**

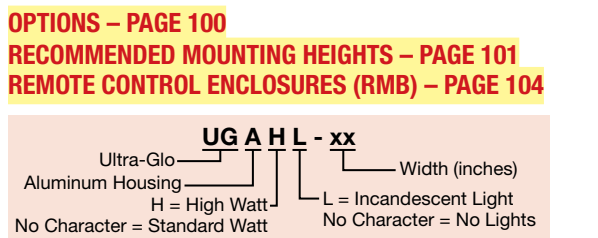

### ULTRA-GLO ALUMINUM CERAMIC INFRARED STRIP HEATERS with LIGHTS

Model	No. of Bulbs	Width	Voltage Single Phase	Watts	Approx. Ship Weight <sup>o</sup>	List Price <sup>o</sup>
<b>Standard Watt</b>						
<b>UGAL-18</b>	1	18"	120, 120/208 or 120/240	560, 550 or 560	11 lbs.	<b>\$1038</b>
<b>UGAL-24</b>	2	24"	120, 120/208 or 120/240	770, 795 or 770	10 lbs.	<b>1057</b>
<b>UGAL-30</b>	2	30"	120, 120/208 or 120/240	870, 960 or 1020	15 lbs.	<b>1271</b>
<b>UGAL-36</b>	3	36"	120, 120/208 or 120/240	1180, 1160 or 1180	19 lbs.	<b>1323</b>
<b>UGAL-42</b>	3	42"	120, 120/208 or 120/240	1380, 1300 or 1380	21 lbs.	<b>1527</b>
<b>UGAL-48</b>	4	48"	120, 120/208 or 120/240	1740, 1710 or 1740	22 lbs.	<b>1579</b>
<b>UGAL-54</b>	4	54"	120/208 or 120/240	1710 or 1740	26 lbs.	<b>1786</b>
<b>UGAL-60</b>	5	60"	120/208 or 120/240	2260 or 2300	30 lbs.	<b>1850</b>
<b>UGAL-66</b>	5	66"	120/208 or 120/240	2260 or 2300	31 lbs.	<b>2043</b>
<b>UGAL-72</b>	6	72"	120/208 or 120/240	2320 or 2360	32 lbs.	<b>2108</b>
<b>High Watt</b>						
<b>UGAHL-18</b>	1	18"	120, 120/208 or 120/240	710, 735, or 710	12 lbs.	<b>\$1046</b>
<b>UGAHL-24</b>	2	24"	120, 120/208 or 120/240	870, 870 or 870	12 lbs.	<b>1065</b>
<b>UGAHL-30</b>	2	30"	120, 120/208 or 120/240	1245, 1245 or 1245	18 lbs.	<b>1279</b>
<b>UGAHL-36</b>	3	36"	120, 120/208 or 120/240	1480, 1530 or 1480	17 lbs.	<b>1331</b>
<b>UGAHL-42</b>	3	42"	120, 120/208 or 120/240	1680, 1680 or 1680	20 lbs.	<b>1535</b>
<b>UGAHL-48</b>	4	48"	120/208 or 120/240	2265 or 2190	23 lbs.	<b>1587</b>
<b>UGAHL-54</b>	4	54"	120/208 or 120/240	2490 or 2490	25 lbs.	<b>1794</b>
<b>UGAHL-60</b> <sup>o</sup>	5	60"	120/208 or 120/240	3000 or 2900	27 lbs.	<b>1858</b>
<b>UGAHL-66</b> <sup>o</sup>	5	66"	120/208 or 120/240	3000 or 2900	30 lbs.	<b>2051</b>
<b>UGAHL-72</b> <sup>o</sup>	6	72"	120/208 or 120/240	3360 or 3360	32 lbs.	<b>2116</b>

**All Ultra-Glo Aluminum Ceramic Infrared Models with Lights Feature:**  
**Models Shipped With:** Angle Brackets and Leads (3' conduit whip).  
**Dimensions With Attached Control Box, Toggle and Indicator Light:** 18"-72"W x 12 7/8"D x 2 1/2"H.  
**Dimensions With Remote Control Enclosure (RMB), Toggle and Indicator Light:** 18"-72"W x 9"D x 2 1/2"H.

<sup>o</sup> Does not include Remote Control Enclosure (RMB).  
<sup>o</sup> Includes either Attached Control or Remote Control Enclosure (RMB) with toggle switch(es) and indicator light(s).  
<sup>o</sup> UGAHL-60, -66, -72 in 120/208 and UGAHL-72 in 120/240 require Remote Control Enclosure (RMB) with a Fuse.

**OPTIONS AND REMOTE CONTROL ENCLOSURES (RMB) – PAGE 100**  
**RECOMMENDED MOUNTING HEIGHTS – PAGE 101**

## Ultra-Glo® Aluminum Ceramic Infrared Dual Strip Heaters

Hatco Ultra-Glo Ceramic Strip Heaters provide the ultimate holding power. Increased height improves working clearances and the heat zone blankets the entire holding area. All models include adjustable angle brackets for mounting. Dual mounted strip heaters accommodate wider food holding areas.

- Increased height improves operational working clearances, giving chef and server an improved ergonomic environment in which to work
- Adaptable to any location and configuration, including back- or front-of-the-house use, open kitchen concepts or buffet lines
- Pre-focused heat pattern provides an increased pyramidal dimension, concentrating heat at the edges where heat loss is the greatest
- Available in widths from 18" to 72"
- Remote Control Enclosure (RMB) with toggle switch, indicator light and wiring for convenient control placement
- Sturdy extruded aluminum housings eliminate sagging



UGAHL-60D with lights in optional Gloss Finish and Standard a 3" spacer - Remote Control Enclosure (RMB) required, not shown

### ULTRA-GLO ALUMINUM CERAMIC INFRARED DUAL STRIP HEATERS

Model	Width	Voltage Single Phase	Watts	Approx. Ship Weight <sup>o</sup>	List Price <sup>o</sup> 3" Spacer 6" Spacer
<b>Standard Watt</b>					
UGA-18D	18"	120, 208 or 240	1000, 980 or 1000	17 lbs.	\$1682 \$1697
UGA-24D	24"	120, 208 or 240	1300, 1350 or 1300	20 lbs.	1753 1768
UGA-30D	30"	120, 208 or 240	1500, 1680 or 1800	26 lbs.	2127 2148
UGA-36D	36"	208 or 240	1960 or 2000	31 lbs.	2197 2218
UGA-42D	42"	208 or 240	2240 or 2400	32 lbs.	2574 2595
UGA-48D	48"	208 or 240	2940 or 3000	40 lbs.	2641 2669
UGA-54D	54"	208 or 240	2940 or 3000	42 lbs.	3010 3038
UGA-60D	60"	208 or 240	3920 or 4000	49 lbs.	3090 3133
UGA-66D	66"	208 or 240	3920 or 4000	50 lbs.	3455 3498
UGA-72D	72"	208 or 240	3920 or 4000	52 lbs.	3562 3605
<b>High Watt</b>					
UGAH-18D	18"	120, 208 or 240	1300, 1350 or 1300	17 lbs.	\$1698 \$1713
UGAH-24D	24"	120, 208 or 240	1500, 1500 or 1500	20 lbs.	1769 1784
UGAH-30D	30"	208 or 240	2250, 2250	24 lbs.	2143 2164
UGAH-36D	36"	208 or 240	2700 or 2600	31 lbs.	2213 2234
UGAH-42D	42"	208 or 240	3000 or 3000	32 lbs.	2590 2611
UGAH-48D	48"	208 or 240	4050 or 3900	40 lbs.	2657 2685
UGAH-54D	54"	208 or 240	4500 or 4500	33 lbs.	3026 3054
UGAH-60D	60"	208 or 240	5400 or 5200	48 lbs.	3106 3149
UGAH-66D	66"	208 or 240	5400 or 5200	50 lbs.	3471 3514
UGAH-72D	72"	208 or 240	6000 or 6000	55 lbs.	3578 3621

### ULTRA-GLO ALUMINUM CERAMIC INFRARED DUAL STRIP HEATERS with LIGHTS

Model	No. of Bulbs	Width	Voltage Single Phase	Watts	Approx. Ship Weight <sup>o</sup>	List Price <sup>o</sup> 3" Spacer 6"Spacer
<b>Standard Watt</b>						
UGAL-18D	1	18"	120, 120/208 or 120/240	1060, 1040 or 1060	18 lbs.	\$1763 \$1778
UGAL-24D	2	24"	120, 120/208 or 120/240	1420, 1470 or 1420	21 lbs.	1797 1812
UGAL-30D	2	30"	120, 120/208 or 120/240	1620, 1800 or 1920	26 lbs.	2240 2261
UGAL-36D	3	36"	120/208 or 120/240	2140 or 2180	30 lbs.	2338 2359
UGAL-42D	3	42"	120/208 or 120/240	2420 or 2580	35 lbs.	2752 2773
UGAL-48D	4	48"	120/208 or 120/240	3180 or 3240	30 lbs.	2841 2869
UGAL-54D	4	54"	120/208 or 120/240	3180 or 3240	41 lbs.	3252 3280
UGAL-60D	5	60"	120/208 or 120/240	4220 or 4300	50 lbs.	3346 3389
UGAL-66D	5	66"	120/208 or 120/240	4220 or 4300	51 lbs.	3740 3783
UGAL-72D	6	72"	120/208 or 120/240	4280 or 4360	56 lbs.	3873 3916
<b>High Watt</b>						
UGAHL-18D	1	18"	120, 120/208 or 120/240	1360, 1410 or 1360	18 lbs.	\$1779 \$1794
UGAHL-24D	2	24"	120, 120/208 or 120/240	1620, 1620 or 1620	16 lbs.	1813 1828
UGAHL-30D	2	30"	120/208 or 120/240	2370 or 2370	24 lbs.	2256 2277
UGAHL-36D	3	36"	120/208 or 120/240	2880 or 2780	27 lbs.	2354 2375
UGAHL-42D	3	42"	120/208 or 120/240	3180 or 3180	34 lbs.	2768 2789
UGAHL-48D	4	48"	120/208 or 120/240	4290 or 4140	35 lbs.	2857 2885
UGAHL-54D	4	54"	120/208 or 120/240	4740 or 4740	45 lbs.	3268 3296
UGAHL-60D	5	60"	120/208 or 120/240	5700 or 5500	49 lbs.	3362 3405
UGAHL-66D	5	66"	120/208 or 120/240	5700 or 5500	51 lbs.	3756 3799
UGAHL-72D	6	72"	120/208 or 120/240	6360 or 6360	57 lbs.	3889 3932

<sup>o</sup> Does not include Remote Control Enclosure (RMB).

<sup>o</sup> Includes either Attached Control or Remote Control Enclosure (RMB) with toggle switch(es) and indicator light(s).

#### All Ultra-Glo Aluminum Ceramic Infrared Dual Models with or without Lights Feature:

Models Shipped With: Angle Brackets and Leads (3' conduit whip).

Dimensions With Attached Control Box, Toggle and Indicator Light: 18" - 72"W x 18 7/8" or 21 7/8"D x 2 1/2"H.

Dimensions With Remote Control Enclosure (RMB), Toggle and Indicator Light: 18" - 72"W x 15" or 18"D x 2 1/2"H.

#### OPTIONS AND REMOTE CONTROL ENCLOSURES (RMB) – PAGE 100

#### RECOMMENDED MOUNTING HEIGHTS – PAGE 101

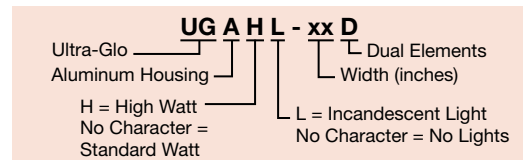

Strip Heaters

**OPTIONS** (available at time of purchase only)

**Designer Colors, aluminum models 18"-36" – Non-standard colors are non-returnable – Clear Anodized Standard –**

<b>COLOR-6</b>	6" Housing for Single UGA and UGAH models, 18"- 36" (color selections below)					<b>per foot \$35</b>
<b>COLOR-9</b>	9" Housing for Single UGAL and UGAHL models, 18"- 36" (color selections below)					<b>per foot 35</b>
<b>COLOR-15, -18</b>	15" and 18" Housings for Dual UGA, UGAH, UGAL, UGAHL models, 18"- 36" (color selections below)					<b>per foot 50</b>
	<b>RED</b> Warm Red	<b>GRAY</b> Gray Granite	<b>NAVY</b> Navy Blue	<b>COPPER</b> Antique Copper		
	<b>BLACK</b> Black	<b>WHITE</b> White Granite	<b>GREEN</b> Hunter Green			

**Gloss Finishes, aluminum models 18"- 36" – Non-standard colors are non-returnable – Clear Anodized Standard –**

<b>GLOSS-6</b>	6" Housing for Single UGA and UGAH models, 18"- 36" (finish selections below)					<b>per foot \$48</b>
<b>GLOSS-9</b>	9" Housing for Single UGAL and UGAHL models, 18"- 36" (finish selections below)					<b>per foot 48</b>
<b>GLOSS-15, -18</b>	15" and 18" Housings for Dual UGA, UGAH, UGAL, UGAHL models, 18"- 36" (finish selections below)					<b>per foot 64</b>
	<b>RRED</b> Radiant Red	<b>GGRAY</b> Glossy Gray	<b>BBLACK</b> Bold Black			
	<b>GGOLD</b> Gleaming Gold	<b>BBLUE</b> Brilliant Blue				

**Designer Colors for Remote Control Enclosures – Non-standard colors are non-returnable – Clear Anodized standard –**

<b>RMB-COLOR</b>	Remote Control Enclosure Housing in Designer Colors					<b>see pages 103 and 104</b>
	<b>RED</b> Warm Red	<b>GRAY</b> Gray Granite	<b>NAVY</b> Navy Blue	<b>COPPER</b> Antique Copper		
	<b>BLACK</b> Black	<b>WHITE</b> White Granite	<b>GREEN</b> Hunter Green			

**Gloss Finishes for Remote Control Enclosures – Non-standard colors are non-returnable – Clear Anodized standard –**

<b>RMB-GLOSS</b>	Remote Control Enclosure Housing in Gloss Finish					<b>see pages 103 and 104</b>
	<b>RRED</b> Radiant Red	<b>GGRAY</b> Glossy Gray	<b>BBLACK</b> Bold Black			
	<b>GGOLD</b> Gleaming Gold	<b>BBLUE</b> Brilliant Blue				

<b>HAL</b>	60 Watt Halogen Bulb in lieu of Standard Display Light	<b>each \$ 69</b>
<b>LIGHTS ADD'L</b>	Extra Lamps – Installed (max. two per ft. less one, one per ft. is standard) – not available for Dual models	<b>each 35</b>
<b>UGA-NTL-14, -16</b>	Non-Adjustable Tubular Stands – specify 14" or 16" clearance	<b>1 pair 131</b>
<b>UGA-NTL-18, -20</b>	Non-Adjustable Tubular Stands – specify 18" or 20" clearance	<b>1 pair 139</b>
<b>UGA-NTL-22</b>	Non-Adjustable Tubular Stands for 22" clearance	<b>1 pair 150</b>
<b>UGA-NTL-18-D, -20-D</b>	Non-Adjustable Tubular Stands for Dual units– specify 18" or 20" clearance	<b>2 pair 278</b>
<b>UGA-NTL-22-D, -24-D, -26-D</b>	Non-Adjustable Tubular Stands for Dual units – specify 22", 24" or 26" clearance	<b>2 pair 300</b>
<b>NTL-PAINT</b>	Designer Colors or Gloss Finishes for Non-Adjustable Tubular Stands to match unit color – Non-Standard colors are non-returnable –	<b>1 pair 50</b>
<b>NTL-PAINT-D</b>	Designer Colors or Gloss Finishes for Non-Adjustable Tubular Stands to match unit color on Dual units– Non-Standard colors are non-returnable –	<b>2 pair 100</b>
<b>Power Leads – must specify lead length –</b>		
<b>HTLEADS5</b>	1'-5' extended Electrical Leads	<b>\$ 41</b>
<b>HTLEADS10</b>	6'-10' extended Electrical Leads	<b>82</b>
<b>HTLEADS15</b>	11'-15' extended Electrical Leads	<b>123</b>
<b>HTLEADS20</b>	16'-20' extended Electrical Leads	<b>164</b>
<b>RMB-UGA-INF</b>	Remote Control Enclosure with Toggle Switch, Electronic Infinite Control, Relay and Indicator Light in lieu of attached control box – Designer Colors and Gloss Finishes available – Non-standard colors are non-returnable Clear anodized Standard –	<b>484</b>

**ACCESSORIES** (available for purchase at any time)

**Chef LED 120V adjustable bulb – UGA(H)L-xx, UGA(H)L-xxD, models only, pass through usage only –**

UGAL models must be at least 14" from surface, UGAHL models must be at least 17" from surface, UGA(H)L-xxD models must be 18"- 22" or higher from surface, all require pass through usage only – bulbs must be rotated down –

<b>CLED-3000-120</b> Similar to warm Halogen light	<b>CLED-4000-120</b> Similar to cool Fluorescent light	<b>each \$139</b>
--	--	-------------------

**COLORS AND FINISHES – INSIDE BACK COVER**



**CLED-3000 or -4000**  
Accessory



**RMB-UGA-INF**



## Strip Heater Recommended Range Above Target\* and Spacing Requirements (based on 24" strip heaters, non-flammable surface)

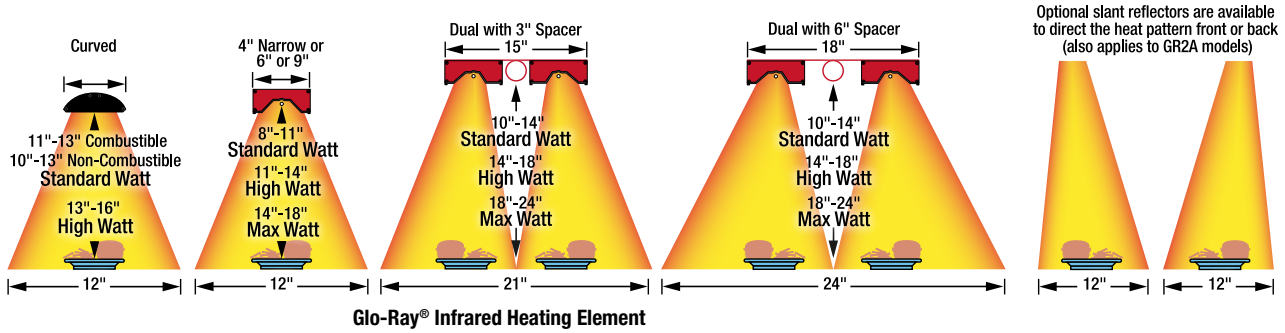

### GLO-RAY® INFRARED

#### Curved Standard Watt (GR5A, GR5AL)

Minimum Combustible: Surface: Install minimum of 1" from back wall, 1" from overshelf and 11" above surface. Minimum non-combustible Surface: 1" from overshelf and 10" above surface (back of wall: no requirement).

#### Curved High Watt (GR5AH, GR5AHL)

Non-combustible surroundings only. Install 1" from overshelf and minimum of 13" above a non-combustible countertop surface (back of wall: no requirement).

#### Singles (GRA, GRAL, GRAH, GRAHL, GRN)

#### Singles Designer (GR2A, GR2AH, GR2AL, GR2AHL)

Combustibles: 13½" high watt or 10" standard watt below, 1" above and 3" to back wall.

Non-combustibles: 1" above, 10" below for high watt with infinite or indicator lamp and 8" below for high watt toggle or standard watt.

Must be installed in a pass-through area. Units with remote switches may be installed against a non-combustible back wall, flush to an overshelf and 8" to a surface below. Maximum 10" setback from the front of an overshelf. Models with cords must be installed 3" below an overshelf and 11" high watt or 10" standard watt over a surface below.

#### Duals (GRA-D, GRAH-D, GRAL-D, GRAHL-D)

#### Duals Designer (GR2A-D, GR2AH-D, GR2AL-D, GR2AHL-D)

May not be installed in combustible surroundings.

Non-combustibles: 1" above, 10" below. Must be installed in a pass-through area. Units with remote switches may be installed 3" from a non-combustible back wall, 8" from surface below and flush to an overshelf. Maximum 10" setback from the front of an overshelf.

#### Singles Max-Watt (GRAM, GRAML, GRNM)

Do not use in combustible surroundings.

Non-combustibles: 1" above, 12" to surface and 3" from back wall. Cord connected: 3" below an overshelf, 12" from surface below. Maximum 10" setback from front of an overshelf.

#### Duals Max-Watt (GRAM-D, GRAML-D)

May not be installed in combustible surroundings.

Non-combustibles: units may be installed 3" from a non-combustible back wall, 1" below an overshelf, 15" to surface below. Maximum 10" setback from the front of an overshelf.

### ULTRA-GLO®

#### Singles and Duals (UGA, UGA-D, UGAH, UGAH-D, UGAL, UGAL-D, UGAHL, UGAHL-D)

May not be installed in combustible surroundings.

Non-combustibles: 1" above, 17" high watt or 14" standard watt from a surface below and 3" from a back wall.

**Dual Mounting** Do not mount warmers side by side (dual mounting) with less than a 3" space between units.

### GLO-RAY® INFRA-BLACK®

#### Singles (GRAIH, GRAIHL, GRAIHL-D, GRAIH-D)

May not be installed in combustible surroundings.

Non-combustibles: 1" above and 4" below. Must be installed in a pass-through area. Units with remote switches may be installed 3" from a non-combustible back wall and flush to an overshelf.

Maximum 10" setback from the front of an overshelf.

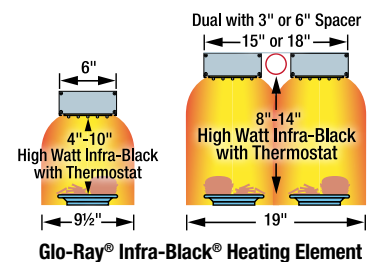
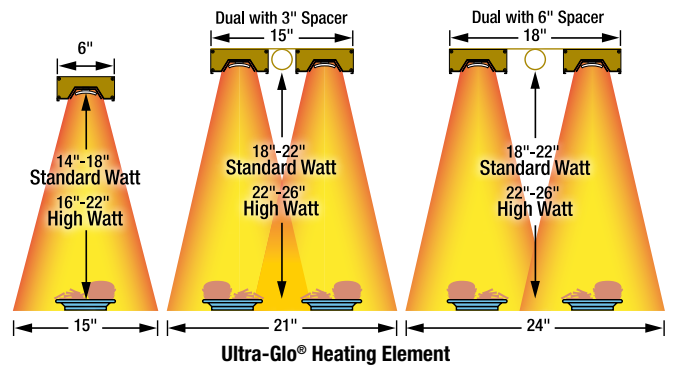
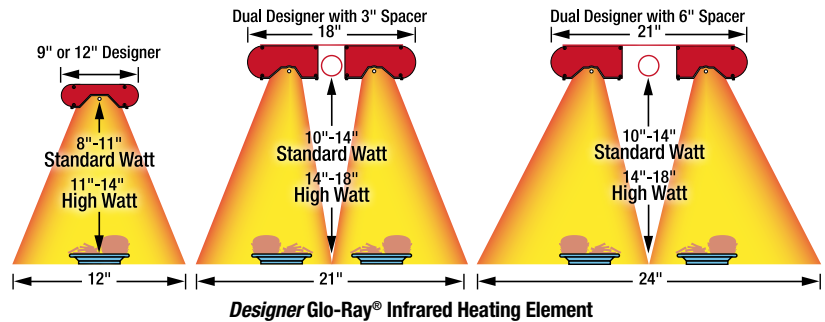

\* Recommended single unit application without base heat, based on ideal conditions. Based on a 24" Strip Heater. Individual applications may vary, consult factory. Non-flammable surface only.

## Glo-Ray® Mounting Arrangements

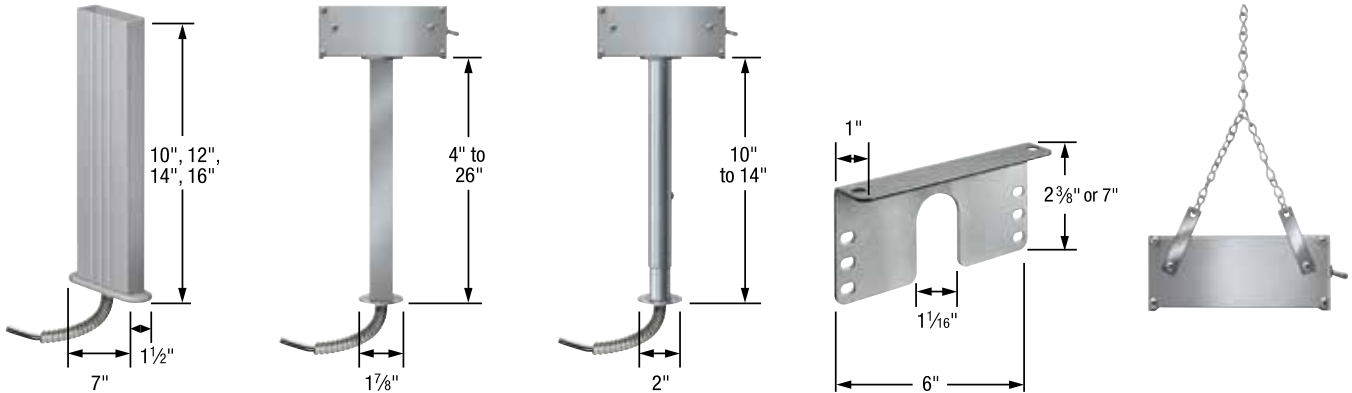

### PERMANENT - For hard wired installation

#### Designer Non-Adjustable Stands

(GR2A series only) Sturdy stands conceal all hook-up wiring. Available in Designer colors.

#### Non-Adjustable Tubular Stands

Sturdy stands conceal all hook-up wiring. Available in Designer Colors. Duals require two pair. Specify bottom power location.

#### Adjustable Tubular Stands

Sturdy tubular stands conceal all hook-up wiring. Duals require two pair (not available on Max Watt® or Ultra-Glo® models). Specify bottom power location.

#### Angle brackets

Special adjustable angle brackets fit 6" or 9" housings for mounting Glo-Ray under a shelf. Provides 1"-2" space or 1"-6" space between Glo-Ray and overshef. Duals require two pair. (standard on Max Watt or Ultra-Glo models).

#### Chain Suspension

Chains attach to tabs provided with warmers and are available in various lengths to suit the location (not available on Max Watt or Ultra-Glo models).

Strip Heaters

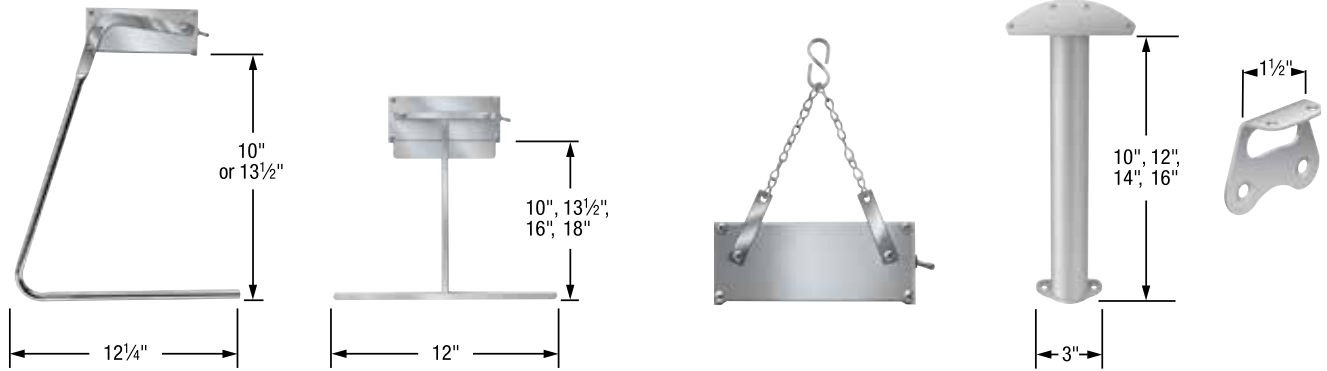

### PORTABLE - For cord and plug installation

#### C-Leg Stands

Attractive chrome plated legs allow easy relocation of the warmer. For models 72" or less in width (not available on Max Watt or Ultra-Glo models). Requires attached cord and plug.

#### T-Leg Stands

Provide rigid stability and allow for more pass-through area below unit. For models 72" or less in width (not available on Max Watt or Ultra-Glo models). Requires attached cord and plug.

### STATIONARY - for cord and plug installation

#### Chain Hook

Chains attach to tabs provided with warmers. 6" chain with S-Hooks for units with cord and plug only.

### GR5A, GR5AH, GR5AL, GR5AHL MOUNTING only

#### Non-Adjustable Tubular Stands and Angle Brackets

Sturdy stands conceal all hook-up wiring. Specify power location. Standard angle brackets for mounting under a shelf. Provides 1" space between Strip Heater and overshef. End panels and brackets match unit color.

## Remote Control Enclosures (RMBs)

1. Find the volt and current (Amp) rating for the Strip Heater(s) the RMB2 will be controlling. This is the total current of all circuits on the warmer(s).
2. If the current rating is under 20 Amps, then select an RMB2-1R, if the current rating is between 20 and 40 Amps, select the RMB2-2R. The RMB2-2R has two 20 Amp outputs.
3. Select the current (Amp) rating of the RMB2 that is just above the total current rating of the warmer(s) it will control. The RMB2 will need to be connected to a branch circuit breaker suitable for its current rating.
4. Select the voltage rating for the RMB2 based on the highest voltage rating of the warmer(s). For example, if the warmer(s) is rated 120/208 volts, select a 208 volt RMB2 control.

- Easy to specify, install and service
- Compatible with most Strip Heaters (GR-XX, GRA-XX(D), GRAIH-XX(D), GR2A-XX(D), GR2AH-XX(D), GR5A-XX(D), GRN-XX, GRNH-XX and GRAM-XX(D) series)
- Total amperage of light and heat combined cannot exceed max Amp rating of the RMB
- Maximum of 8 Amps total allowed on the light circuit
- Multiple Strip Heaters may be connected to one RMB2 if the combined current draw of the warmers is less than the rating of the RMB2. All warmers will be controlled with same set-point

Need help choosing the correct RMB? "Choose Remote Box (RMB)" can be found on: [www.hatcocorp.com](http://www.hatcocorp.com) under "Resources"



**RMB2-2R**  
with two relays



**RMB2-1R**  
with one relay

Strip Heaters

### REMOTE CONTROL ENCLOSURES (RMBs)

Model	Description	Voltage	List Price
<b>RMB2</b>			
<b>RMB2-1R – 1 Toggle, 1 Infinite, 1 Relay, 1 Indicator</b>			
	12 Max. Amps	120, 208, 240	<b>\$943</b>
	16 Max. Amps	120, 208, 240	
	20 Max. Amps	120, 208, 240	
<b>RMB2-2R – 1 Toggle, 1 Infinite, 2 Relays, 1 Indicator</b>			
	24 Max. Amps	120, 208, 240	<b>\$1075</b>
	32 Max. Amps	120, 208, 240	
	40 Max. Amps	120, 208, 240	

**All Models Feature:**

**Ship Weight:** 6-8 lbs. depending on components.

**Dimensions: RMB2-1R:** 11" W x 4½" D x 5½" H.

**RMB2-2R:** 14" W x 4½" D x 5½" H.

**Cutout Dimensions: RMB2-1R:** 10¼" W x 4¾" H.

**RMB2-2R:** 13⅞" W x 4¾" H.



### Remote Control Enclosures (RMBs)

Hatco Remote Control Enclosures (RMBs) are built in accordance with UL standards for toggle or infinite switches, indicator lights and wiring, ready for installation when purchased with Glo-Ray® Strip Heaters. When Remote Control Enclosures are used, no more than one RMB per Strip Heater and no more than one Strip Heater per RMB.

- Built for toggle or infinite switches, indicator lights and wiring
- One RMB per Strip Heater
- Consult RMB configurator for specific details at [www.hatcocorp.com](http://www.hatcocorp.com), under "Resources"

RMB-7L with toggle switch and infinite control



RMB-16E with infinite controls, toggle switches and optional Designer Warm Red



RMB-14E with infinite controls



RMB-3F with toggle switch and indicator light

RMB-7D with toggle switches and optional Designer Hunter Green



### REMOTE CONTROL ENCLOSURES (RMBs)

Model	Description	Voltage	Width	List Price
RMB-3A, -3B, -3C	1 Infinite	120, 208, 240	5½"	\$206
RMB-3D	1 Toggle	120, 208, 240	5½"	183
RMB-3E	2 Toggle	120, 208, 240	5½"	206
RMB-3F, -3G, -3H	1 Toggle, 1 Indicator	120, 208, 240	5½"	206
RMB-7A, -7B, -7C	2 Infinite	120, 208, 240	9"	276
RMB-7D	3 Toggle	120, 208, 240	9"	255
RMB-7E	4 Toggle	120, 208, 240	9"	299
RMB-7F, -7G, -7H	1 Infinite, 1 Indicator	120, 208, 240	9"	247
RMB-7I, -7J, -7K	2 Toggle, 2 Indicator	120, 208, 240	9"	273
RMB-7L, -7M, -7N	1 Toggle, 1 Infinite	120, 208, 240	9"	252
RMB-7O, -7P, -7Q	1 Toggle, 1 Infinite, 1 Indicator	120, 208, 240	9"	276
RMB-7S	2 Toggles, 1 Indicator	120/208, 120/240	9"	252
RMB-14A, -14B, -14C	3 Infinite	120, 208, 240	14"	356
RMB-14D, -14E, -14F	4 Infinite	120, 208, 240	14"	440
RMB-14G	5 Toggle	120, 208, 240	14"	378
RMB-14H	6 Toggle	120, 208, 240	14"	445
RMB-14I, -14J, -14K	3 Toggle, 3 Indicator	120, 208, 240	14"	348
RMB-14L, -14M, -14N	2 Infinite, 2 Indicator	120, 208, 240	14"	360
RMB-14O, -14P, -14Q	2 Toggle, 2 Infinite	120, 208, 240	14"	391
RMB-14R, -14S, -14T	1 Toggle, 1 Infinite w/Relay, 1 Indicator	120, 208, 240	14"	473
RMB-14V, -14W, -14Y	1 Toggle, 2 Infinite	120, 208, 240	14"	342
RMB-14AA, -14AB	Master Toggle, 1 Electronic Infinite w/Relay	120, 208, 240	14"	473
RMB-14AF, -14AG, -14AH	3 Toggle, 2 Indicator	120, 208, 240	14"	324
RMB-14AI, -14AJ, -14AK	1 Toggle, 3 Infinite	120, 208, 240	14"	402
RMB-14AL, -14AM, -14AN	1 Toggle, 2 Infinite, 2 Indicator	120, 208, 240	14"	382
RMB-14AO, -14AP, -14AQ	1 Toggle, 2 Infinite, 3 Indicator	120, 208, 240	14"	405
RMB-14AR, -14AS, -14AT	1 Infinite with Relay, 1 Indicator	120, 208, 240	14"	444
RMB-16B, -16C, -16D	1 Toggle, 4 Infinite	120, 208, 240	16"	474
RMB-16E, -16F, -16G	3 Toggle, 2 Infinite	120, 208, 240	16"	436
RMB-20D, -20E, -20F	3 Toggle, 2 Infinite	120, 208, 240	20"	455
RMB-20G, -20H, -20I	2 Toggle, 4 Infinite	120, 208, 240	20"	542
RMB-20L, -20J, -20K	3 Toggle, 4 Infinite, 4 Indicator	120, 208, 240	20"	642
RMB-20M, -20N, -20P	3 Toggle, 2 Infinite, 2 Indicator	120, 208, 240	20"	500
RMB-20R, -20S, -20T	2 Toggle, 4 Infinite, 4 Indicator	120, 208, 240	20"	621
RMB-20AA, -20AB, -20AC	2 Toggle, 2 Infinite, 2 Indicator	120, 208, 240	20"	474
RMB-20AH, -20AF, -20AG	4 Infinite, 4 Indicator	120, 208, 240	20"	564
RMB-20AN, -20AO, -20AP	4 Toggle, 4 Indicator	120, 208, 240	20"	460

All Models Feature:

Ship Weight: 2-8 lbs. depending on components.

Max. Allowable Amperage per Switch: Toggle 15.0; Infinite 12.2.

Dimensions (not including switches): 5½", 9", 14", 16" or 20"W x 3"D x 2½"H.

Toggle Switch: Max. 15 Amps  
Infinite Switch: Max. 12.2 Amps

Remote Control Enclosures (RMBs): When used, no more than one RMB per Strip Heater and no more than one Strip Heater per RMB.

Need help choosing the correct RMB?  
"Choose Remote Box (RMB)" can be found on:  
[www.hatcocorp.com](http://www.hatcocorp.com)  
under "Resources"

Strip Heaters

### OPTIONS (available at time of purchase only)

Designer Colors – Non-standard colors are non-returnable – Clear Anodized Standard –

RMB-COLOR	Remote Control Enclosure Housing in Designer Color						\$50	
	RED	Warm Red	GRAY	Gray Granite	NAVY	Navy Blue	COPPER	Antique Copper
	BLACK	Black	WHITE	White Granite	GREEN	Hunter Green		

Gloss Finishes – Non-standard colors are non-returnable – Clear Anodized Standard –

RMB-GLOSS	Remote Control Enclosure Housing in Gloss Finish			\$71		
	RRED	Radiant Red	GGRAY	Glossy Gray	BBLACK	Bold Black
	GGOLD	Gleaming Gold	BBLUE	Brilliant Blue		

### COLORS AND FINISHES – INSIDE BACK COVER



# Fry Stations

*Supermarkets & Delis  
Restaurants & Cafés • Clubs & Bars*



**GRFF** in optional Brilliant Blue Gloss finish and **UGFF** in optional Glossy Gray Gloss Finish *pg. 106*



**GRFFL** with optional 9" display sign holder (sign not included) and *Designer Warm Red* color, and accessory food pan *pg. 106*



**GRFHS-PT26** with accessory 8-pleat hardcoated fry box ribbon (scoop not included) *pg. 108*



**GRFHS-PTT21** *pg. 108*



**GRFSC-18** with swing-away post mount, cord with plug and accessory food pan *pg. 108*



**MPWS-36** shown with optional fry bin insert *pg. 110*

## Portable Foodwarmers

Opt for the versatility of Hatco's Glo-Ray® and Ultra-Glo® Portable Foodwarmers. With heat from above, below or both, these foodwarmers offer design flexibility without sacrificing food product quality. Ideal for use next to fry stations, drive-through windows and service areas that require frequent and easy access.

- Portable – ready to plug in and use
- Versatile – available in many sizes, styles and heat sources to fit your needs
- Flexible – both top and bottom heat available
- Available with incandescent bulbs containing special protective coating to guard against food contamination
- Ceramic heating elements provide more distance between the heat source and the holding pan (UGFF series only)
- Toggle switch is standard; infinite switch optional on GRFF series
- All base heat units (GR-B, GRFFB and UGFFB) have a preset automatic thermostat to maintain consistent temperatures



**GR-B** Heated Base with accessory sheet pan

**GRFFB** with optional infinite switch and accessory food pans



**UGFFL** in optional Radiant Red Gloss finish with accessory fry ribbon and food pan



### GLO-RAY® PORTABLE FOODWARMERS

Model	No. of Bulbs	Dimensions W x D x H	Voltage Single Phase	Watts	Plug	Approx. Ship Weight	List Price
GR-B	–	12¾" x 22" x 2¼"	120	250	NEMA 5-15P	14 lbs.	<b>\$ 730</b>
GRFF	–	12¾" x 24" x 15⅞"	120	500	NEMA 5-15P	14 lbs.	<b>721</b>
GRFFL	2	12¾" x 24" x 15⅞"	120	620	NEMA 5-15P	14 lbs.	<b>927</b>
GRFFB <sup>⚡</sup>	–	12¾" x 24" x 16"-20"	120	750	NEMA 5-15P	29 lbs.	<b>1186</b>
GRFFBL <sup>⚡</sup>	2	12¾" x 24" x 16"-20"	120	870	NEMA 5-15P	34 lbs.	<b>1363</b>

<sup>⚡</sup> Standard clearance is 14". Specify 12" or 16" if required.

#### All Portable Models Feature:

Models Shipped with: 6' cord and plug.

Cord Location: GR-B, GRFFB, GRFFBL: Back, lower middle.

GRFF, GRFFL: Back, upper middle.

### ULTRA-GLO® PORTABLE FOODWARMERS WITH CERAMIC ELEMENTS

Model	No. of Bulbs	Dimensions W x D x H	Voltage Single Phase	Watts	Plug	Approx. Ship Weight	List Price
UGFF	–	12¾" x 22¼" x 18⅞"	120	750	NEMA 5-15P	15 lbs.	<b>\$ 903</b>
UGFFL	2	12¾" x 22¼" x 18⅞"	120	870	NEMA 5-15P	17 lbs.	<b>1114</b>
UGFFB	–	12¾" x 22½" x 22"	120	1000	NEMA 5-15P	25 lbs.	<b>1360</b>
UGFFBL	2	12¾" x 22½" x 22"	120	1120	NEMA 5-15P	34 lbs.	<b>1576</b>

#### All Ceramic Portable Models Feature:

Models Shipped with: 6' cord and plug.

Cord Location: UGFF, UGFFL: Back, upper middle.

UGFFB, UGFFBL: Back, lower middle.

### OPTIONS AND ACCESSORIES – PAGE 107

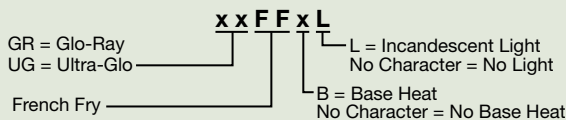



**UGFFB** with accessory food pan (perforated pan not available)

**OPTIONS** (available at time of purchase only)

**Designer Colors (one color per unit, heated base is not powdercoated, not available for GR-B models)**

**Non-standard colors are non-returnable – Clear Anodized standard –**

<b>RED</b>	Warm Red	<b>\$164</b>
<b>BLACK</b>	Black	<b>164</b>
<b>GRAY</b>	Gray Granite	<b>164</b>
<b>WHITE</b>	White Granite	<b>164</b>
<b>NAVY</b>	Navy Blue	<b>164</b>
<b>GREEN</b>	Hunter Green	<b>164</b>
<b>COPPER</b>	Antique Copper	<b>164</b>

**Gloss Finishes (one color per unit, heated base is not painted, not available for GR-B models)**

**Non-standard colors are non-returnable –**

<b>RRED</b>	Radiant Red	<b>\$227</b>
<b>GGOLD</b>	Gleaming Gold	<b>227</b>
<b>GGRAY</b>	Glossy Gray	<b>227</b>
<b>BBLUE</b>	Brilliant Blue	<b>227</b>
<b>BBLACK</b>	Bold Black	<b>227</b>

**Clearance (from bottom of Glo-Ray® to top of heated surface) – GRFFB, GRFFBL only – 14" standard –**

<b>12"</b>	<b>No Charge</b>
<b>16"</b>	<b>No Charge</b>

<b>SIGN HOLD</b>	Sign Holder for GRFFL model with Back Toggle only (requires 9"W x 5½"H x ¼"D sign, which is not included and adds 3" to height of unit)	<b>\$51</b>
<b>INF</b>	Infinite Control (not available on models GR-B, UGFF, UGFFL, UGFFB or UGFFBL)	<b>51</b>
<b>HAL</b>	60 Watt Halogen Bulb in lieu of standard Display Light	<b>each 69</b>

**ACCESSORIES** (available for purchase at any time)

<b>5PLTBOX</b>	Five-Pleat Hardcoated French Fry Box Ribbon – 19¼"W x 9¼"D x 2"H	<b>\$250</b>
<b>8PLTBAG</b>	Eight-Pleat Hardcoated French Fry Bag Ribbon – 19¼"W x 9¼"D x 2"H	<b>250</b>

**Chef LED 120V adjustable bulb – bulbs must be rotated down – excludes any model without existing bulbs –**

<b>CLED-3000-120</b> Similar to warm Halogen light	<b>CLED-4000-120</b> Similar to cool Fluorescent light	<b>each 139</b>
--	--	-----------------

**FOOD PANS AND TRIVETS – PAGE 245**  
**COLORS AND FINISHES – INSIDE BACK COVER**



**CLED-3000 and -4000** Accessory

Fry Stations



## Glo-Ray® Fry Stations

Hatco offers convenient Glo-Ray® Fry Stations that can be placed where they are most needed – next to a fryer! Glo-Ray heat technology offers the ability to keep fried foods at optimum temperatures, ready to serve, without cooking or drying them out.

- Accessory hardcoated fry ribbons stage boxed or bagged products for quick-service areas
- Thermostatically-controlled heated base maintains uniform holding temperatures from below (GRFHS series)
- Portable models including pass-through style (GRFHS series)
- Sectional divider permits holding of multiple products simultaneously (GRFHS series)
- Ceramic elements and slotted holding bin prevent soggy product (GRFHS series)
- Accessory hardcoated fry ribbons absorb more radiant heat than stainless steel, can be up to 15° to 20°F hotter (GRFHS series)
- Fry Station Warmers (GRFSC, GRFS series) feature a built-in top heat source and a swing-away post mount
- GRFSC series available with ceramic heating element, while the GRFS series has a metal sheathed element
- Variety of clearances (GRFS series)
- GRFS series has power toggle switch, cord and plug, plus optional infinite control

**GRFHS-21** with optional right-hand cutout for fry basket and accessory fry ribbon (left-hand cutout also available)



**GRFHS-PTT21**



**GRFHS-16**



**GRFSC-18**  
Swing-away post mount

### PORTABLE FRY HOLDING STATIONS

Model	No. of Bulbs	Dimensions (W x D x H)	Voltage (Single Phase)	Watts	Plug	Approx. Ship Weight	List Price
GRFHS-16 <sup>↔</sup>	2	16 <sup>19</sup> / <sub>64</sub> " x 22 <sup>19</sup> / <sub>64</sub> " x 22 <sup>49</sup> / <sub>64</sub> "	120	1090	NEMA 5-15P	51 lbs.	<b>\$3663</b>
GRFHS-21 <sup>↔</sup>	2	21 <sup>19</sup> / <sub>64</sub> " x 28 <sup>3</sup> / <sub>8</sub> " x 22 <sup>49</sup> / <sub>64</sub> "	120	1200	NEMA 5-15P	63 lbs.	<b>4040</b>
GRFHS-22	2	21 <sup>29</sup> / <sub>64</sub> " x 18 <sup>3</sup> / <sub>8</sub> " x 17 <sup>1</sup> / <sub>32</sub> "	120	1030	NEMA 5-15P	44 lbs.	<b>3476</b>
GRFHS-26 <sup>↔</sup>	2	26 <sup>19</sup> / <sub>64</sub> " x 23 <sup>3</sup> / <sub>8</sub> " x 22 <sup>9</sup> / <sub>64</sub> "	120	1200	NEMA 5-15P	66 lbs.	<b>4137</b>
GRFHS-PT16 <sup>♣</sup>	2	16 <sup>19</sup> / <sub>64</sub> " x 23 <sup>13</sup> / <sub>64</sub> " x 24 <sup>3</sup> / <sub>8</sub> "	120	1090	NEMA 5-15P	60 lbs.	<b>3663</b>
GRFHS-PT26 <sup>♣</sup>	2	29 <sup>5</sup> / <sub>8</sub> " x 22 <sup>23</sup> / <sub>32</sub> " x 24 <sup>3</sup> / <sub>8</sub> "	120	1440	NEMA 5-15P	64 lbs.	<b>4137</b>
GRFHS-PT26 <sup>♣</sup>	2	29 <sup>5</sup> / <sub>8</sub> " x 22 <sup>23</sup> / <sub>32</sub> " x 26 <sup>1</sup> / <sub>16</sub> "	120	1440	NEMA 5-15P	64 lbs.	<b>4290</b>
GRFHS-PTT16 <sup>♣</sup>	2	18 <sup>1</sup> / <sub>2</sub> " x 22 <sup>13</sup> / <sub>32</sub> " x 22 <sup>1</sup> / <sub>2</sub> "	120	1300	NEMA 5-15P	65 lbs.	<b>4175</b>
GRFHS-PTT21 <sup>↔♣</sup>	2	24 <sup>25</sup> / <sub>32</sub> " x 38" x 22 <sup>1</sup> / <sub>2</sub> "	120	1740	NEMA 5-15P	100 lbs.	<b>4207</b>

- ↔ Add 1<sup>3</sup>/<sub>4</sub>" to width if ordering Scoop Holder.
- ♣ Standard with fixed scoop holder (not accessory FHS-SH).
- ♣ Includes a built-in 6" deep heated food holding base (4" is standard on all other models).

#### All Portable Fry Holding Station Models Feature:

**Plug:** GRFHS-PTT21 uses NEMA 5-20P in Canada.  
**Models Shipped with:** One slotted holding bin and one sectional divider.  
**Cord Location:** GRFHS-16, -21, -22, -26, -PT16, -PT26, -PTT16: Back side, lower right corner.  
 GRFHS-PTT16, -PTT21: Lower right-hand side.



**GRFS, GRFSL, GRFSC, GRFSL** with swing-away post mount and cord with plug

Fry Stations

### FRY STATION WARMERS

Model	No. of Bulbs	Dimensions (W x D x H)	Voltage (Single Phase)	Watts	Plug	Approx. Ship Weight	List Price
GRFSC-18 <sup>♣</sup>	—	6" x 18" x 19 <sup>1</sup> / <sub>4</sub> "-22 <sup>1</sup> / <sub>2</sub> "	120	750	NEMA 5-15P	11 lbs.	<b>\$773</b>
GRFSL-18 <sup>♣</sup>	2	9" x 18" x 19 <sup>1</sup> / <sub>4</sub> "-22 <sup>1</sup> / <sub>2</sub> "	120	870	NEMA 5-15P	13 lbs.	<b>933</b>
GRFSCR-18 <sup>♣†</sup>	—	6" x 18" x 19 <sup>1</sup> / <sub>4</sub> "-22 <sup>1</sup> / <sub>2</sub> "	120	750	—	12 lbs.	<b>774</b>
GRFSLR-18 <sup>♣†</sup>	2	9" x 18" x 19 <sup>1</sup> / <sub>4</sub> "-22 <sup>1</sup> / <sub>2</sub> "	120	870	—	13 lbs.	<b>933</b>
GRFS-24 <sup>♣</sup>	—	6" x 24" x 12 <sup>1</sup> / <sub>2</sub> "-15 <sup>1</sup> / <sub>2</sub> "	120	500	NEMA 5-15P	10 lbs.	<b>626</b>
GRFSL-24 <sup>♣</sup>	2	9" x 24" x 12 <sup>1</sup> / <sub>2</sub> "-15 <sup>1</sup> / <sub>2</sub> "	120	620	NEMA 5-15P	13 lbs.	<b>797</b>
GRFSR-24 <sup>♣†</sup>	—	6" x 24" x 12 <sup>1</sup> / <sub>2</sub> "-15 <sup>1</sup> / <sub>2</sub> "	120	500	—	10 lbs.	<b>626</b>
GRFSLR-24 <sup>♣†</sup>	2	9" x 24" x 12 <sup>1</sup> / <sub>2</sub> "-15 <sup>1</sup> / <sub>2</sub> "	120	620	—	13 lbs.	<b>797</b>

- ♣ Specify clearance of 16<sup>3</sup>/<sub>4</sub>", 18" (standard) or 20" when ordering.
- † Fry Station Warmer without cord and plug, UL recognized. Supply wires through mounting post.
- ♣ Specify clearance of 10", 11", 12" or 13" (standard) when ordering.

#### All Fry Station Warmer Models Feature:

**Toggle Switch Location:** Ceramic Heating Element Models: Back of unit.  
 Metal Sheathed Heating Element Models: Front of unit.  
**Cord Location** GRFSC-18, GRFSL-18, GRFS-24 and GRFSL-24: Back, upper middle.

### OPTIONS AND ACCESSORIES – PAGE 109

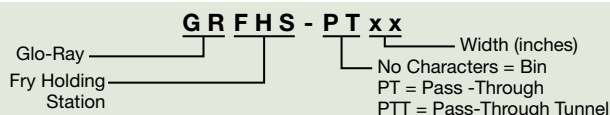



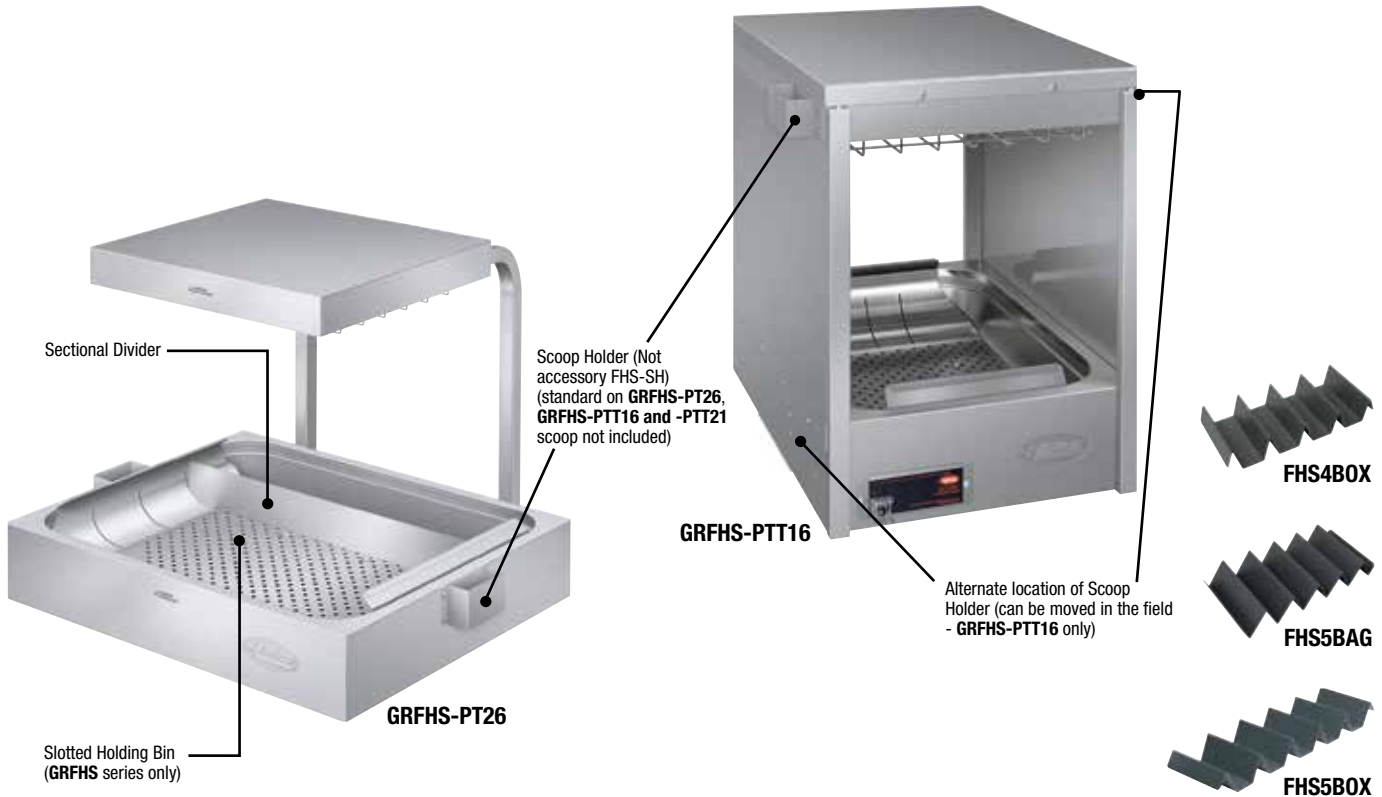

**OPTIONS** (available at time of purchase only)

<b>FHS-CUT</b>	Right- or Left-Hand Cutout for Fry Basket – must specify side at time of order Adds 1 1/16" to width of unit (GRFHS-16, -21, -26 models only)	<b>No Charge</b>
<b>INF</b>	Infinite Control (metal sheathed GRFS models only)	<b>\$51</b>
<b>HAL</b>	60 Watt Halogen Bulb in lieu of standard Display Light	<b>each 69</b>

**ACCESSORIES** (available for purchase at any time)

<b>FHS4BOX</b>	Four-Pleat Hardcoated Fry Box Ribbon (All models) – 10 3/4"W x 5"D x 1 3/4"H	<b>\$ 96</b>
<b>FHS5BAG</b>	Five-Pleat Hardcoated Fry Bag Ribbon (All models) – 11 1/4"W x 5"D x 1 7/8"H	<b>96</b>
<b>FHS5BOX</b>	Five-Pleat Hardcoated Fry Box Ribbon (GRFHS-21, -PT26, -PTT16, -PTT21) – 17 1/2"W x 5"D x 1 7/8"H	<b>156</b>
<b>FHS6BAG</b>	Six-Pleat Hardcoated Fry Bag Ribbon (GRFHS-21, -PT26, -PTT16, -PTT21) – 13 3/4"W x 5"D x 2"H	<b>105</b>
<b>FHS6BB</b>	Six-Pleat Hardcoated Fry Box/Bag Ribbon (GRFHS-21, -PT26, -PTT16, -PTT21) – 17 1/4"W x 5"D x 1 3/4"H	<b>156</b>
<b>FHS7BAG</b>	Seven-Pleat Hardcoated Fry Bag Ribbon (GRFHS-21, -PT26, -PTT21) – 17 7/8"W x 5"D x 1 7/8"H	<b>156</b>
<b>PTT16-10BAG</b>	Ten-Pleat Hardcoated Hashbrown Ribbon – (GRFHS-PT26, -PTT21) – 15"W x 3 7/8"D x 1 3/4"H	<b>147</b>
<b>5BH</b>	5" Side-by-Side Bag Holder (GRFHS-21)	<b>64</b>
<b>FHS-SH</b>	Scoop Holder – adds 1 1/4" to width of unit – Differs from standard on GRFHS-PT26, -PTT16 & -PTT21 models, not available for GRFHS-22 (Scoop Holder on GRFHS-PTT16 can be moved to two alternate locations in the field)	<b>64</b>
<b>FHSDIV1</b>	Sectional Divider – 16" W x 3 3/4" H – GRFHS-16, -26 and -PTT16 models	<b>38</b>

**Chef LED 120V adjustable bulb – bulbs must be rotated down –**

<b>CLED-3000-120</b> Similar to warm Halogen light	<b>CLED-4000-120</b> Similar to cool Fluorescent light	<b>each 139</b>
--	--	-----------------

**FOOD PANS AND TRIVETS – PAGE 245**



**CLED-3000 and -4000**  
Accessory



**FHS-SH**

Fry Stations



## Multi-Product Warming Stations

Hatco's redesigned Multi-Product Warming Station safely holds hot fried foods at optimum serving temperatures in kitchen work areas. The unit is designed for maximum durability and performance with minimum maintenance.

- New removable left/right side panel
- New wider, deeper side openings
- Easy access to food product
- Coated shatter-resistant incandescent lights enhance brilliant product display while safeguarding food from bulb breakage
- Six overhead ceramic heating elements are adjusted by two separate electronic infinite controls – one for the rear elements and one for the front elements
- Thermostatically controlled base heat assures safe serving temperatures
- All stainless steel construction
- Master On/Off rocker switch

### ENDLESS POSSIBILITIES OF CONFIGURATION

Incremental spacing between portable dividers is 5/8"



MPWS-36 with accessory angled risers, fry pan and trivet (plastic pans not available)



Shown with accessory fry bin insert and standard detachable side panel on right side



Shown with optional fry pans, accessory fry ribbon on angled riser and accessory scoop holder



Shown with optional fry pans, and accessory angled riser and scoop holder (plastic pans not available)



Shown with accessory fry ribbons on angled risers, fry pan and scoop holder (plastic pans not available)

### MULTI-PRODUCT WARMING STATIONS

Model	No. of Bulbs	Dimensions W x D x H	Watts		Plug	Approx. Ship Weight	List Price
			120/208V	120/240V			
MPWS-36	4	37 <sup>7</sup> / <sub>16</sub> " x 24 <sup>13</sup> / <sub>16</sub> " x 32 <sup>3</sup> / <sub>4</sub> "	2773	2755	NEMA L14-20P	152 lbs.	\$5937
MPWS-45	4	45 <sup>7</sup> / <sub>16</sub> " x 24 <sup>13</sup> / <sub>16</sub> " x 32 <sup>3</sup> / <sub>4</sub> "	2799	2780	NEMA L14-20P	170 lbs.	6640

### OPTION CAPACITIES

Model	Fry Pan with Trivet	Angled Risers
MPWS-45	1 2 0	4 2 6

#### All Multi-Product Warming Station Models Feature:

Models Shipped with: 4" adjustable legs.

Cord Location: Back side, upper left corner.

### OPTIONS (available at time of purchase only)

HAL	60 Watt Halogen Bulb in lieu of standard Display Light	each \$69
-----	--	-----------

### ACCESSORIES (available for purchase at any time)

FHS4BOX	Four-Pleat Hardcoated Fry Box Ribbon – 10 <sup>3</sup> / <sub>4</sub> "W x 5"D x 1 <sup>3</sup> / <sub>4</sub> "H	\$ 96
FHS5BAG	Five-Pleat Hardcoated Fry Bag Ribbon – 11 <sup>1</sup> / <sub>4</sub> "W x 5"D x 1 <sup>7</sup> / <sub>8</sub> "H	96
5BH	5" Side-by-Side Bag Holder	64
FHS-SH	Scoop Holder	64
MPWS-RISER	Angled Riser	128
MPWS-PT	Fry Pan and Trivet	562
MPWS36BIN	Full Fry Bin Insert for MPWS-36 unit only (includes Drip Tray, Perforated Insert and 3 Dividers)	each 533
MPWS45BIN	Full Fry Bin Insert for MPWS-45 unit only (includes Drip Tray, Perforated Insert and 4 Dividers)	each 570

#### Chef LED 120V adjustable bulb – bulbs must be rotated down –

CLED-3000-120	Similar to warm Halogen light	CLED-4000-120	Similar to cool Fluorescent light	each 139
---------------	-------------------------------	---------------	-----------------------------------	----------

### FOOD PANS AND TRIVETS – PAGE 245



CLED-3000 and -4000 Accessory

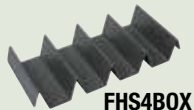

FHS4BOX



FHS5BAG



5BH



FHS-SH



MPWS36BIN



MPWS-PT



MPWS-RISER

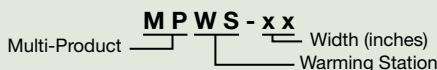

# Carving Stations

*Supermarkets & Delis  
Restaurants & Cafés • Clubs & Bars*



**DCSB400-1CM** models above two **HGS-1P** models *pg. 112*



**DCSB400-R24-1** with optional Bermuda Sand base and optional Bright Brass post and shade *pg. 112*



**DCSB400-R24-1** with optional Gray Granite base and Standard Bright Nickel post and shade. Shown with **GR2S-36** *pg. 112*



**DCSB400-R24-1** with optional Gray Granite base and Standard Bright Nickel post and shade *pg. 112*



**GRC-SCL-24** with accessory left-hand sneeze guard, drip pan and cutting board *pg. 113*



**ACCESSORIES (CSCL-BOARD shown)** *pg. 113*



## Decorative Carving Stations

Decorative Carving Stations provide proper food serving temperatures by combining the Hatco Decorative Heat Lamp with a simulated stone Heated Base to create an attractive carving display. Perfect for chef stations in restaurants, hotels, country clubs, casinos and for any catered event.

- Available as post mount, permanent counter mount or freestanding with a rounded or rectangular heated simulated stone base (DCS400-1, -1CM do not have bases)
- The patented telescoping heated Decorative Lamp has a 30° shade pivot
- Heated bases are made of foodsafe materials and controlled by an adjustable thermostat and power switch
- Units come with matching cutting board (except DCS400-1, -1CM), keeping juices contained and tablecloths clean
- DCS400-1 has a 40 lb. weighted base, perfect for buffet use
- Sneeze guard is removable for easy cleaning (DCSB400-R24-1, -2420-1, -3624-2 models only)
- Models with simulated stone are Swanstone®

**DCS400-1CM**  
with optional Bright Brass post and optional Bermuda Sand trim ring



**DCSB400-R24-1**  
with optional Bermuda Sand base and Standard Bright Nickel post and shade



**DCSB400-3624-2**  
with Standard Night Sky base and Standard Bright Nickel posts and shades

### DECORATIVE CARVING STATIONS

Model	No. of Lamps	Width	Heated Base Surface Area	Voltage Single Phase	Watts	Plug	Approx. Ship Weight	List Price
DCS400-1	1	8"	—	120	250	NEMA 5-15P	32 lbs.	\$1770
DCS400-1CM	1	6 1/8"	—	120	250	NEMA 5-15P	18 lbs.	1734
DCSB400-R24-1	1	26"	24" diameter	120	600	NEMA 5-15P	75 lbs.	4419
DCSB400-2420-1	1	24"	24"W x 20"D	120	750	NEMA 5-15P	82 lbs.	4418
DCSB400-3624-2	2	36"	36"W x 24"D	120	1300	NEMA 5-15P	128 lbs.	6391

**All Decorative Carving Station Models Feature:**

- Models Ship with: **DCS400-1, -1CM:** One clear coated bulb. **DCS400-1** includes black base.  
**DCSB400-R24-1, -2420-1:** One clear coated bulb, base heat, glass sneeze guard and cutting board.  
**DCSB400-3624-2:** Two clear coated bulbs, base heat, glass sneeze guard and cutting board.  
 Telescoping Clearance: **DCS400-1, -1CM:** (bottom of shade to counter) 16"-28".  
**DCSB400-R24-1, -2420-1, -3624-2:** (bottom of shade to top of cutting board) 14"-26".  
 Cord Location: **DCS400-1:** Base of unit, server side center. **DCS400-1CM:** Under counter.  
**DCSB400-R24-1, -2420-1, -3624-2:** Base of unit, server side on left.

**DCS400-1**  
with optional Bright Brass post and shade and black base



### OPTIONS (available at time of purchase only)

**Shade and post(s) in Plated Finish, no additional charge – Non-Standard colors are non-returnable – Bright Nickel Standard –**

BBRASS	Bright Brass	No Charge
BCOPPER	Bright Copper	No Charge
ABRASS	Antique Brass	No Charge
ABRONZE	Antique Bronze	No Charge

**Base and Cutting Board (except DCS400-1, -1CM) in simulated stone, no additional charge – Non-Standard colors are non-returnable – Night Sky Standard –**

GGRAN	Gray Granite	No Charge
BSAND	Bermuda Sand	No Charge

**Trim Ring (DCS400-1CM only) in simulated stone, no additional charge – Non-Standard colors are non-returnable – Night Sky Standard –**

GGRAN	Gray Granite	No Charge
BSAND	Bermuda Sand	No Charge

### ACCESSORIES (available for purchase at any time)

RED-CTD-120	120 Volt, 250 Watt, Red Bulb, Coated	each \$50
-------------	--------------------------------------	-----------

### COLORS AND FINISHES – INSIDE BACK COVER



Close-up of **Trim Ring** in Standard Night Sky (Unit shown in Optional Plated Antique Bronze finish)

### DCSBxxx-xxx-xCM

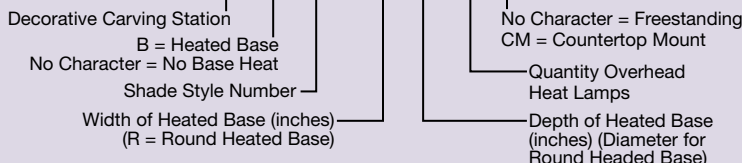



## Glo-Ray® Carving Stations

An excellent addition to extend food holding times during serving periods is the Glo-Ray® Carving Station. Create a complete serving station for buffets by adding it to Hatco's Flav-R-Savor® Holding Cabinet.

- Overhead ceramic heating elements project high intensity radiant heat over entire target area
- Adjustable clearance of 17½" to 23½"
- Portable – includes a 6' cord and plug
- Shatter-resistant incandescent lights illuminate holding area
- Drip pan and cutting board available
- GRCSCLH has base heat



**GRC SCL-24** with accessory left-hand sneeze guard, drip pan and cutting board



**GRC SCLH-24** with accessory left-hand sneeze guard, drip pan and cutting board



**GRC SCLH-24** controls

### CARVING STATIONS

Model	No. of Bulbs	Dimensions W <sup>**</sup> x D x H	Voltage Single Phase	Watts	Plug	Approx. Ship Weight	List Price
<b>GRC SCL-24</b>	4	26" x 28" x 22½"-28½"	120	990	NEMA 5-15P	57 lbs.	<b>\$4079</b>
<b>GRC SCLH-24</b>	4	26" x 28" x 22½"-28½"	120	1290	NEMA 5-15P	57 lbs.	<b>4606</b>

\* Width includes accessory left-hand sneeze guard.

**All Carving Station Models Feature:**

**Models Shipped with:** Right-hand sneeze guard.

**Cord Location:** Back side on base.

### OPTIONS (available at time of purchase only)

<b>HAL</b>	60 Watt Halogen Bulb in lieu of Standard Display Light	each \$69
------------	--	-----------

### ACCESSORIES (available for purchase at any time)

<b>CSCLB/PACC</b>	Left-Hand Sneeze Guard Kit (3 lbs.)	<b>\$309</b>
<b>CSCL-PAN</b>	Stainless Steel custom Drip Pan – 20" x 26¾" x 1" – (9 lbs.)	<b>319</b>
<b>CSCL-BOARD</b>	Approved foodsafe Cutting Board – 18" x 24" x 1¼" – (19 lbs.)	<b>301</b>

**Chef LED 120V adjustable bulb – bulbs must be rotated down –**

<b>CLED-3000-120</b>	Similar to warm Halogen light	<b>CLED-4000-120</b>	Similar to cool Fluorescent light	each 139
----------------------	-------------------------------	----------------------	-----------------------------------	----------



**CSCLB/PACC**

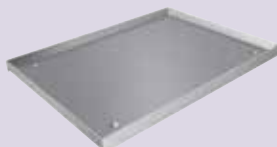

**CSCL-PAN**



**CSCL-BOARD**



**CLED-3000 and -4000**  
Accessory

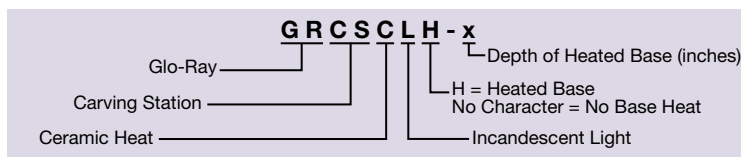

# Portables

*Cafeterias • Buffets • Convenience Stores  
Supermarkets & Delis • Restaurants & Cafés  
Clubs & Bars • Catering • Concessions*



**GRSSR** with optional 3" or 5" risers in standard Night Sky simulated stone *pg. 117*



**GRSSR20-DL77516** with standard Night Sky simulated stone heated base *pg. 117*



**GRS-72-1** with Accessory food pans *pg. 119*



**GR2S-30** with optional *Designer Hunter Green* inset panels and Accessory pizza pans *pg. 121*



**GRSS-3618** in optional *Bermuda Sand* simulated stone *pg. 122*



**HBG-2418** in optional *White Glass* *pg. 123*



**GRHW-1SGDS** (signage not included) *pg. 125*



**GRHW-1SG** *pg. 125*



**GRBW-72** Two units side by side *pg. 126*

## Portable Lamp Warmer

The portable, powdercoated Hatco Lamp Warmer has a specially-designed stand that keeps food holding pans above the countertop and provides insulation to extend holding times.

- Features two vented lamps with heavy-duty sockets
- Adjustable stand from 24<sup>3</sup>/<sub>8</sub>" to 30<sup>3</sup>/<sub>8</sub>" in height
- Cord and plug with in-line power switch

- Gray Granite is Standard color with optional *Designer Colors* available: Warm Red, Black, Gray Granite, White Granite, Navy Blue, Hunter Green, Antique Copper (non-standard colors are non-returnable)
- Holds food pans, wire trivets and fry ribbons



LW-2 in optional *Designer* Black with Accessory food pans

### PORTABLE LAMP WARMER

Model	No. of Bulbs	Dimensions W x D x H	Voltage Single Phase	Watts	Plug	Approx. Ship Weight	List Price
LW-2	2	12 <sup>3</sup> / <sub>8</sub> " x 21 <sup>1</sup> / <sub>2</sub> " x 24 <sup>3</sup> / <sub>8</sub> "-30 <sup>3</sup> / <sub>8</sub> "	120	500	NEMA 5-15P	18 lbs.	\$873

**All Portable Lamp Warmer Models Feature:**

**Bulbs:** Two 250 Watt *uncoated* clear bulbs.

**Cord Location:** 6' cord and plug, located back of adjustable stand near top.

**Lamp Distance:** 10<sup>1</sup>/<sub>2</sub>"-16<sup>1</sup>/<sub>2</sub>" space from bottom of lamp to top of base.

### OPTIONS (available at time of purchase only)

**Designer Colors – Non-standard colors are non-returnable – Gray Granite standard –**

<b>RED</b>	Warm Red	<b>No Charge</b>
<b>BLACK</b>	Black	<b>No Charge</b>
<b>WHITE</b>	White Granite	<b>No Charge</b>
<b>NAVY</b>	Navy Blue	<b>No Charge</b>
<b>GREEN</b>	Hunter Green	<b>No Charge</b>
<b>COPPER</b>	Antique Copper	<b>No Charge</b>

### ACCESSORIES (available for purchase at any time)

<b>WHITE-CTD-120</b>	250 Watt Clear Bulb, Coated (unit accommodates two bulbs)	<b>each \$40</b>
<b>RED-UCTD-120</b>	250 Watt Red Bulb, Uncoated (unit accommodates two bulbs)	<b>each 39</b>
<b>RED-CTD-120</b>	250 Watt Red Bulb, Coated (unit accommodates two bulbs)	<b>each 50</b>

**FRY RIBBONS – PAGE 109**

**FOOD PANS AND TRIVETS – PAGE 245**

**COLORS AND FINISHES – INSIDE BACK COVER**

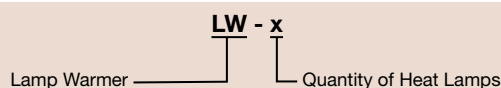





### Glo-Ray® Portable Round Heated Shelves

The contemporary-styled Round Heated Shelves keeps hot food at serving temperatures. Ideal when used for wrapped product or for use behind a sneeze guard with unwrapped food like pizza, biscuits, muffins and cookies.

- Unit is designed for countertop or built-in use – see cutout dimensions shown below
- Uniform heat distribution with blanket-type element
- Thermostatically-controlled heated base
- Available in three sizes to hold standard 15", 17" or 19" diameter pans
- Optional stainless steel trim



GRSR-17 in optional Designer Navy Blue with Accessory food pan

GRSR-19 in optional Designer Hunter Green with Accessory pizza pan

#### GLO-RAY PORTABLE ROUND HEATED SHELVES

Model	Dimensions Diameter x H	Max. Pan Size Diameter	Voltage Single Phase	Watts	Plug	Approx. Ship Weight	List Price
GRSR-15	16¾" x 3⅞"	15"	120	250	NEMA 5-15P	12 lbs.	<b>\$1076</b>
GRSR-17	18¾" x 3⅞"	17"	120	325	NEMA 5-15P	14 lbs.	<b>1133</b>
GRSR-19	20¾" x 3⅞"	19"	120	400	NEMA 5-15P	17 lbs.	<b>1201</b>

All Glo-Ray Portable Round Heated Shelf Models Feature:  
Cord Location: 6' cord and plug, located underneath.

#### OPTIONS (available at time of purchase only)

Designer Colors – Non-standard colors are non-returnable – Black standard –

RED	Warm Red	No Charge
GRAY	Gray Granite	No Charge
WHITE	White Granite	No Charge
NAVY	Navy Blue	No Charge
GREEN	Hunter Green	No Charge
COPPER	Antique Copper	No Charge
SS SIDE	Stainless Steel Side	No Charge

FOOD PANS AND TRIVETS – PAGE 245  
COLORS AND FINISHES – INSIDE BACK COVER

#### PORTABLE ROUND HEATED SHELVES COUNTERTOP CUTOUT DIMENSIONS (For Built-in Applications)

Model	Minimum Diameter	Maximum Diameter	Below Counter
GRSR-15	16⅞"	16¼"	5⅞"
GRSR-17	18⅞"	18¼"	5⅞"
GRSR-19	20⅞"	20¼"	5⅞"

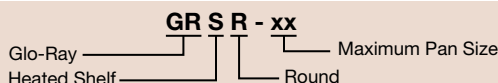



## Glo-Ray® Portable Round Heated Simulated Stone Shelves

Hatco's Glo-Ray® Simulated Stone Round Portable Heated Shelves are made of foodsafe materials and are offered in three colors. These unique warmers will safely hold food hot while blending in with your décor and are ideal for buffet lines or as hors d'oeuvre displays.

- Blanket-type element creates uniform heat across the entire simulated stone surface
- Features a lighted rocker switch and thermostatically-controlled heated base to help hold your food hot and delicious
- Optional 3" or 5" risers available in stainless steel (Standard) or Designer Colors
- Models with simulated stone are Swanstone®

**GRSSR-16** in Standard Night Sky simulated stone with optional 3" riser in optional Designer Gray Granite



**GRSSR-18** in Standard Night Sky simulated stone with optional 5" riser in optional Designer Warm Red



**GRSSR-20** in Standard Night Sky simulated stone



**GRSSR20-DL77516** in Standard Night Sky simulated stone with Standard Designer Black Base and Lamp



### GLO-RAY PORTABLE ROUND HEATED SIMULATED STONE SHELVES

Model	Dimensions Dia. x H	Voltage Single Phase	Watts	Amps	Plug	Approx. Ship Weight	List Price
GRSSR-16	16" x 2 5/8"	120	250	2.1	NEMA 5-15P	14 lbs.	<b>\$1385</b>
GRSSR-18	18" x 2 5/8"	120	325	2.7	NEMA 5-15P	16 lbs.	<b>1477</b>
GRSSR-20	20" x 2 5/8"	120	400	3.3	NEMA 5-15P	18 lbs.	<b>1569</b>

All Glo-Ray Portable Round Heated Simulated Stone Shelf Models Feature:

Temperature Range: 100°-200°F.

Cord Location: 6' cord and plug, located on back side on base.

### GLO-RAY PORTABLE ROUND HEATED SIMULATED STONE SHELVES with DECORATIVE LAMP

Model	Dimensions W x D x H	Voltage Single Phase	Watts	Amps	Plug	Approx. Ship Weight	List Price
GRSSR16-DL77516	16" x 20 1/2" x 36"	120	500	4.2	NEMA 5-15P	27 lbs.	<b>\$1971</b>
GRSSR18-DL77516	18" x 21 1/2" x 36"	120	575	4.8	NEMA 5-15P	30 lbs.	<b>2062</b>
GRSSR20-DL77516	20" x 22 1/2" x 36"	120	650	5.4	NEMA 5-15P	32 lbs.	<b>2153</b>

All Glo-Ray Portable Round Heated Simulated Stone Shelf Models with Decorative Lamp Feature:

Bulb: One, 250 Watt clear bulb, uncoated.

Temperature Range: 100°-200°F.

Cord Location: 6' cord and plug, located on back side on base.

Lamp Distance: 16 1/4" space from bottom of shade to base.

### OPTIONS AND ACCESSORIES – PAGE 118

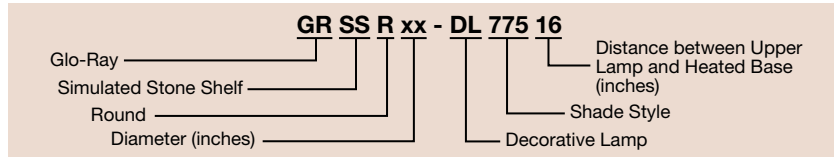



Two GRSSR20-DL77516 units in optional Gray Granite simulated stone and Standard Designer Black Base and Shade

**OPTIONS** (available at time of purchase only)

<b>120H-CTD-W</b>	120V, 375W Clear Coated Bulb in lieu of 120V uncoated white bulb (High Watt models only)	<b>\$65</b>
<b>120H-UCTD-W</b>	120V, 375W Clear Uncoated Bulb in lieu of 120V uncoated white bulb (High Watt models only)	<b>50</b>

**Designer Color Base (and Lamp for GRSSRxx-DL77516 models) – Non-standard colors are non-returnable – Black standard –**

<b>RED</b>	Warm Red	<b>No Charge</b>
<b>GRAY</b>	Gray Granite	<b>No Charge</b>
<b>WHITE</b>	White Granite	<b>No Charge</b>
<b>NAVY</b>	Navy Blue	<b>No Charge</b>
<b>GREEN</b>	Hunter Green	<b>No Charge</b>
<b>COPPER</b>	Antique Copper	<b>No Charge</b>

**Simulated stone color – Non-standard colors are non-returnable – Night Sky standard –**

<b>SS-GGRAN</b>	Gray Granite	<b>No Charge</b>
<b>SS-BSAND</b>	Bermuda Sand	<b>No Charge</b>

**3" Risers (not available on the GRSSRxx-DL77516 models) – Available in Designer Colors– Non-standard colors are non-returnable – Stainless Steel standard –**

<b>3RISER16</b>	GRSSR-16	<b>\$70</b>
<b>3RISER18</b>	GRSSR-18	<b>70</b>
<b>3RISER20</b>	GRSSR-20	<b>70</b>

**5" Risers (not available on the GRSSRxx-DL77516 models) – Available in Designer Colors – Non-standard colors are non-returnable – Stainless Steel standard –**

<b>5RISER16</b>	GRSSR-16	<b>\$90</b>
<b>5RISER18</b>	GRSSR-18	<b>90</b>
<b>5RISER20</b>	GRSSR-20	<b>90</b>

**ACCESSORIES** (available for purchase at any time)

<b>WHITE-CTD-120</b>	250 Watt Clear Bulb, Coated (GRSSRxx-DL77516 models accommodate one bulb)	<b>each \$40</b>
<b>RED-UCTD-120</b>	250 Watt Red Bulb, Uncoated (GRSSRxx-DL77516 models accommodate one bulb)	<b>each 39</b>
<b>RED-CTD-120</b>	250 Watt Red Bulb, Coated (GRSSRxx-DL77516 models accommodate one bulb)	<b>each 50</b>

**COLORS AND FINISHES – INSIDE BACK COVER**

## Glo-Ray® Portable Heated Shelves

Whether you need a heated workspace or extra base heat in a pass-through or buffet area, Hatco's full line of Glo-Ray® Heated Shelf options can help you. Using a blanket heating element for an even temperature, the thermostatically-controlled base safely extends the holding time of your food.

Flexibility, style and quality mark these workhorses of the buffet. Available in a variety of widths and depths to meet your specific needs.

- Uniform heat distribution with a blanket-type element
- Built-in adjustable thermostat controls surface temperature
- Extruded aluminum base with stainless steel top – optional Hardcoat Aluminum surface
- Accessory 4" legs (Standard on 36" and wider models)
- Accessory slant leg kit and pan rail
- Model widths from 18" to 72"
- Model depths: 6", 7<sup>3</sup>/<sub>4</sub>", 9<sup>3</sup>/<sub>4</sub>", 12", 13<sup>3</sup>/<sub>4</sub>", 15<sup>1</sup>/<sub>2</sub>", 15<sup>3</sup>/<sub>4</sub>", 17<sup>1</sup>/<sub>2</sub>", 19<sup>1</sup>/<sub>2</sub>", 21<sup>1</sup>/<sub>2</sub>", 23<sup>1</sup>/<sub>2</sub>", 25<sup>1</sup>/<sub>2</sub>"
- Optional Designer Colors: Warm Red, Black, Gray Granite, White Granite, Navy Blue, Hunter Green, Antique Copper. Non-standard colors are non-returnable
- New optional Thermostat Guard available (GRS models only)



**GRS-30-I** in optional Designer Warm Red with Accessory pan rail and food pans

### GLO-RAY PORTABLE HEATED SHELVES

Model	Dimensions W x H	Voltage Single Phase	Watts	Plugs	Approx. Ship Weight	List Price
<b>19½" depth I – Standard 19½" depth accommodates 12" x 20" steam table pans</b>						
GRS-18-I	18" x 2 <sup>3</sup> / <sub>8</sub> "	120	250	NEMA 5-15P	16 lbs.	<b>\$1048</b>
GRS-24-I	24" x 2 <sup>3</sup> / <sub>8</sub> "	120	350	NEMA 5-15P	20 lbs.	<b>1146</b>
GRS-30-I	30" x 2 <sup>3</sup> / <sub>8</sub> "	120	450	NEMA 5-15P	25 lbs.	<b>1235</b>
GRS-36-I	36" x 5 <sup>3</sup> / <sub>8</sub> "	120	550	NEMA 5-15P	28 lbs.	<b>1321</b>
GRS-42-I	42" x 5 <sup>3</sup> / <sub>8</sub> "	120	600	NEMA 5-15P	32 lbs.	<b>1493</b>
GRS-48-I	48" x 5 <sup>3</sup> / <sub>8</sub> "	120	700	NEMA 5-15P	36 lbs.	<b>1556</b>
GRS-54-I	54" x 5 <sup>3</sup> / <sub>8</sub> "	120	800	NEMA 5-15P	42 lbs.	<b>1676</b>
GRS-60-I	60" x 5 <sup>3</sup> / <sub>8</sub> "	120	900	NEMA 5-15P	44 lbs.	<b>1737</b>
GRS-66-I	66" x 5 <sup>3</sup> / <sub>8</sub> "	120	1000	NEMA 5-15P	50 lbs.	<b>1804</b>
GRS-72-I	72" x 5 <sup>3</sup> / <sub>8</sub> "	120	1100	NEMA 5-15P	56 lbs.	<b>1954</b>
<b>6" depth A</b>						
GRS-18-A	18" x 2 <sup>3</sup> / <sub>8</sub> "	120	100	NEMA 5-15P	7 lbs.	<b>\$ 780</b>
GRS-24-A	24" x 2 <sup>3</sup> / <sub>8</sub> "	120	125	NEMA 5-15P	11 lbs.	<b>806</b>
GRS-30-A	30" x 2 <sup>3</sup> / <sub>8</sub> "	120	150	NEMA 5-15P	9 lbs.	<b>840</b>
GRS-36-A	36" x 5 <sup>3</sup> / <sub>8</sub> "	120	175	NEMA 5-15P	11 lbs.	<b>869</b>
GRS-42-A	42" x 5 <sup>3</sup> / <sub>8</sub> "	120	225	NEMA 5-15P	15 lbs.	<b>962</b>
GRS-48-A	48" x 5 <sup>3</sup> / <sub>8</sub> "	120	250	NEMA 5-15P	16 lbs.	<b>990</b>
GRS-54-A	54" x 5 <sup>3</sup> / <sub>8</sub> "	120	275	NEMA 5-15P	17 lbs.	<b>1015</b>
GRS-60-A	60" x 5 <sup>3</sup> / <sub>8</sub> "	120	300	NEMA 5-15P	18 lbs.	<b>1037</b>
GRS-66-A	66" x 5 <sup>3</sup> / <sub>8</sub> "	120	325	NEMA 5-15P	20 lbs.	<b>1114</b>
GRS-72-A	72" x 5 <sup>3</sup> / <sub>8</sub> "	120	350	NEMA 5-15P	22 lbs.	<b>1131</b>
<b>7¾" depth B</b>						
GRS-18-B	18" x 2 <sup>3</sup> / <sub>8</sub> "	120	100	NEMA 5-15P	10 lbs.	<b>\$ 807</b>
GRS-24-B	24" x 2 <sup>3</sup> / <sub>8</sub> "	120	125	NEMA 5-15P	10 lbs.	<b>840</b>
GRS-30-B	30" x 2 <sup>3</sup> / <sub>8</sub> "	120	150	NEMA 5-15P	12 lbs.	<b>884</b>
GRS-36-B	36" x 5 <sup>3</sup> / <sub>8</sub> "	120	175	NEMA 5-15P	14 lbs.	<b>923</b>
GRS-42-B	42" x 5 <sup>3</sup> / <sub>8</sub> "	120	225	NEMA 5-15P	19 lbs.	<b>1015</b>
GRS-48-B	48" x 5 <sup>3</sup> / <sub>8</sub> "	120	250	NEMA 5-15P	19 lbs.	<b>1063</b>
GRS-54-B	54" x 5 <sup>3</sup> / <sub>8</sub> "	120	275	NEMA 5-15P	20 lbs.	<b>1083</b>
GRS-60-B	60" x 5 <sup>3</sup> / <sub>8</sub> "	120	300	NEMA 5-15P	21 lbs.	<b>1136</b>
GRS-66-B	66" x 5 <sup>3</sup> / <sub>8</sub> "	120	325	NEMA 5-15P	26 lbs.	<b>1153</b>
GRS-72-B	72" x 5 <sup>3</sup> / <sub>8</sub> "	120	350	NEMA 5-15P	24 lbs.	<b>1207</b>

**All Glo-Ray Portable Heated Shelf Models Feature:**

- Pan Capacity (12" x 20"): GRS-18-I, -24-I = 1-pan
- GRS-30-I, -36-I = 2-pan
- GRS-42-I, -48-I = 3-pan
- GRS-54-I, -60-I = 4-pan
- GRS-66-I, -72-I = 5-pan

Cord Location: 6' cord and plug, located, center of side with switch.

**OPTIONS AND ACCESSORIES – PAGE 121**

### GLO-RAY PORTABLE HEATED SHELVES continued...

Model	Dimensions W x H	Voltage Single Phase	Watts	Plugs	Approx. Ship Weight	List Price
<b>9¾" depth C</b>						
GRS-18-C	18" x 2 <sup>3</sup> / <sub>8</sub> "	120	125	NEMA 5-15P	9 lbs.	<b>\$1083</b>
GRS-24-C	24" x 2 <sup>3</sup> / <sub>8</sub> "	120	175	NEMA 5-15P	13 lbs.	<b>884</b>
GRS-30-C	30" x 2 <sup>3</sup> / <sub>8</sub> "	120	225	NEMA 5-15P	14 lbs.	<b>932</b>
GRS-36-C	36" x 5 <sup>3</sup> / <sub>8</sub> "	120	275	NEMA 5-15P	16 lbs.	<b>976</b>
GRS-42-C	42" x 5 <sup>3</sup> / <sub>8</sub> "	120	300	NEMA 5-15P	18 lbs.	<b>1083</b>
GRS-48-C	48" x 5 <sup>3</sup> / <sub>8</sub> "	120	350	NEMA 5-15P	20 lbs.	<b>1136</b>
GRS-54-C	54" x 5 <sup>3</sup> / <sub>8</sub> "	120	400	NEMA 5-15P	22 lbs.	<b>1161</b>
GRS-60-C	60" x 5 <sup>3</sup> / <sub>8</sub> "	120	450	NEMA 5-15P	25 lbs.	<b>1229</b>
GRS-66-C	66" x 5 <sup>3</sup> / <sub>8</sub> "	120	500	NEMA 5-15P	28 lbs.	<b>1267</b>
GRS-72-C	72" x 5 <sup>3</sup> / <sub>8</sub> "	120	550	NEMA 5-15P	28 lbs.	<b>1309</b>
<b>12" depth D</b>						
GRS-18-D	18" x 2 <sup>3</sup> / <sub>8</sub> "	120	200	NEMA 5-15P	12 lbs.	<b>\$ 869</b>
GRS-24-D	24" x 2 <sup>3</sup> / <sub>8</sub> "	120	250	NEMA 5-15P	15 lbs.	<b>932</b>
GRS-30-D	30" x 2 <sup>3</sup> / <sub>8</sub> "	120	300	NEMA 5-15P	17 lbs.	<b>990</b>
GRS-36-D	36" x 5 <sup>3</sup> / <sub>8</sub> "	120	350	NEMA 5-15P	20 lbs.	<b>1039</b>
GRS-42-D	42" x 5 <sup>3</sup> / <sub>8</sub> "	120	450	NEMA 5-15P	23 lbs.	<b>1156</b>
GRS-48-D	48" x 5 <sup>3</sup> / <sub>8</sub> "	120	500	NEMA 5-15P	26 lbs.	<b>1219</b>
GRS-54-D	54" x 5 <sup>3</sup> / <sub>8</sub> "	120	550	NEMA 5-15P	30 lbs.	<b>1269</b>
GRS-60-D	60" x 5 <sup>3</sup> / <sub>8</sub> "	120	600	NEMA 5-15P	34 lbs.	<b>1323</b>
GRS-66-D	66" x 5 <sup>3</sup> / <sub>8</sub> "	120	650	NEMA 5-15P	36 lbs.	<b>1379</b>
GRS-72-D	72" x 5 <sup>3</sup> / <sub>8</sub> "	120	700	NEMA 5-15P	37 lbs.	<b>1433</b>
<b>13¾" depth E</b>						
GRS-18-E	18" x 2 <sup>3</sup> / <sub>8</sub> "	120	200	NEMA 5-15P	13 lbs.	<b>\$ 905</b>
GRS-24-E	24" x 2 <sup>3</sup> / <sub>8</sub> "	120	250	NEMA 5-15P	14 lbs.	<b>975</b>
GRS-30-E	30" x 2 <sup>3</sup> / <sub>8</sub> "	120	300	NEMA 5-15P	18 lbs.	<b>1029</b>
GRS-36-E	36" x 5 <sup>3</sup> / <sub>8</sub> "	120	350	NEMA 5-15P	22 lbs.	<b>1097</b>
GRS-42-E	42" x 5 <sup>3</sup> / <sub>8</sub> "	120	450	NEMA 5-15P	26 lbs.	<b>1219</b>
GRS-48-E	48" x 5 <sup>3</sup> / <sub>8</sub> "	120	500	NEMA 5-15P	29 lbs.	<b>1283</b>
GRS-54-E	54" x 5 <sup>3</sup> / <sub>8</sub> "	120	550	NEMA 5-15P	31 lbs.	<b>1348</b>
GRS-60-E	60" x 5 <sup>3</sup> / <sub>8</sub> "	120	600	NEMA 5-15P	36 lbs.	<b>1408</b>
GRS-66-E	66" x 5 <sup>3</sup> / <sub>8</sub> "	120	650	NEMA 5-15P	38 lbs.	<b>1461</b>
GRS-72-E	72" x 5 <sup>3</sup> / <sub>8</sub> "	120	700	NEMA 5-15P	40 lbs.	<b>1534</b>

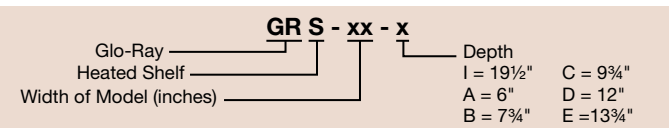



## Glo-Ray® Portable Heated Shelves

continued



GRS-60-I



GRS-30-I in optional Designer Black with Accessory food pans, shown below a GRAH-36 Strip Heater in optional Designer Warm Red, infinite switch and Accessory C-leg stand

### GLO-RAY PORTABLE HEATED SHELVES continued...

Model	Dimensions W x H	Voltage		Approx. Ship Weight	List Price
		Single Phase	Watts		
<b>15½" depth F</b>					
GRS-18-F	18" x 2¾"	120	200	14 lbs.	\$ 947
GRS-24-F	24" x 2¾"	120	250	17 lbs.	1004
GRS-30-F	30" x 2¾"	120	300	22 lbs.	1075
GRS-36-F	36" x 5¾"	120	350	25 lbs.	1136
GRS-42-F	42" x 5¾"	120	450	26 lbs.	1272
GRS-48-F	48" x 5¾"	120	500	32 lbs.	1339
GRS-54-F	54" x 5¾"	120	550	38 lbs.	1420
GRS-60-F	60" x 5¾"	120	600	39 lbs.	1487
GRS-66-F	66" x 5¾"	120	650	42 lbs.	1544
GRS-72-F	72" x 5¾"	120	700	46 lbs.	1636
<b>15¾" depth G</b>					
GRS-18-G	18" x 2¾"	120	225	17 lbs.	\$ 963
GRS-24-G	24" x 2¾"	120	300	18 lbs.	1041
GRS-30-G	30" x 2¾"	120	375	21 lbs.	1114
GRS-36-G	36" x 5¾"	120	450	27 lbs.	1184
GRS-42-G	42" x 5¾"	120	525	29 lbs.	1336
GRS-48-G	48" x 5¾"	120	600	33 lbs.	1411
GRS-54-G	54" x 5¾"	120	675	38 lbs.	1491
GRS-60-G	60" x 5¾"	120	750	42 lbs.	1568
GRS-66-G	66" x 5¾"	120	825	47 lbs.	1581
GRS-72-G	72" x 5¾"	120	900	46 lbs.	1708
<b>17½" depth H</b>					
GRS-18-H	18" x 2¾"	120	225	16 lbs.	\$1000
GRS-24-H	24" x 2¾"	120	300	18 lbs.	1092
GRS-30-H	30" x 2¾"	120	375	21 lbs.	1168
GRS-36-H	36" x 5¾"	120	450	27 lbs.	1269
GRS-42-H	42" x 5¾"	120	525	32 lbs.	1410
GRS-48-H	48" x 5¾"	120	600	35 lbs.	1501
GRS-54-H	54" x 5¾"	120	675	40 lbs.	1585
GRS-60-H	60" x 5¾"	120	750	44 lbs.	1668
GRS-66-H	66" x 5¾"	120	825	49 lbs.	1693
GRS-72-H	72" x 5¾"	120	900	50 lbs.	1836

All Glo-Ray Portable Heated Shelf Models Feature:  
Cord Location: 6' cord and plug, located, center of side with switch.

### OPTIONS AND ACCESSORIES – PAGE 121

### GLO-RAY PORTABLE HEATED SHELVES continued...

Model	Dimensions W x H	Voltage		Approx. Ship Weight	List Price
		Single Phase	Watts		
<b>21½" depth J</b>					
GRS-18-J	18" x 2¾"	120	300	19 lbs.	\$1137
GRS-24-J	24" x 2¾"	120	375	24 lbs.	1199
GRS-30-J	30" x 2¾"	120	450	30 lbs.	1293
GRS-36-J	36" x 5¾"	120	525	33 lbs.	1384
GRS-42-J	42" x 5¾"	120	675	39 lbs.	1564
GRS-48-J	48" x 5¾"	120	750	45 lbs.	1648
GRS-54-J	54" x 5¾"	120	825	49 lbs.	1759
GRS-60-J	60" x 5¾"	120	900	53 lbs.	1845
GRS-66-J	66" x 5¾"	120	975	60 lbs.	1943
GRS-72-J	72" x 5¾"	120	1050	64 lbs.	2068
<b>23½" depth K</b>					
GRS-18-K	18" x 2¾"	120	325	19 lbs.	\$1192
GRS-24-K	24" x 2¾"	120	425	27 lbs.	1257
GRS-30-K	30" x 2¾"	120	525	33 lbs.	1354
GRS-36-K	36" x 5¾"	120	625	36 lbs.	1458
GRS-42-K	42" x 5¾"	120	750	43 lbs.	1636
GRS-48-K	48" x 5¾"	120	850	48 lbs.	1742
GRS-54-K	54" x 5¾"	120	950	52 lbs.	1844
GRS-60-K	60" x 5¾"	120	1050	56 lbs.	1960
GRS-66-K	66" x 5¾"	120	1150	68 lbs.	2075
GRS-72-K	72" x 5¾"	120	1250	69 lbs.	2173
<b>25½" depth L</b>					
GRS-18-L	18" x 2¾"	120	350	22 lbs.	\$1249
GRS-24-L	24" x 2¾"	120	475	26 lbs.	1309
GRS-30-L	30" x 2¾"	120	600	33 lbs.	1415
GRS-36-L	36" x 5¾"	120	725	37 lbs.	1532
GRS-42-L	42" x 5¾"	120	825	43 lbs.	1719
GRS-48-L	48" x 5¾"	120	950	50 lbs.	1837
GRS-54-L	54" x 5¾"	120	1075	58 lbs.	1953
GRS-60-L	60" x 5¾"	120	1200	60 lbs.	2065
GRS-66-L	66" x 5¾"	120	1325	64 lbs.	2214
GRS-72-L	72" x 5¾"	120	1450	69 lbs.	2297

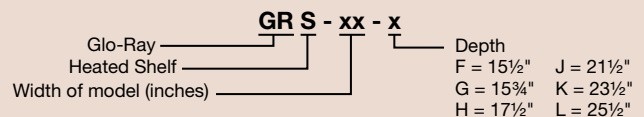



## Glo-Ray® Designer Portable Heated Shelves

Using a blanket heating element for an even temperature, the thermostatically-controlled base safely extends the holding time of your food. Hatco's Designer Portable Heated Shelves can blend into any décor.

- Built-in adjustable thermostatic controls
- Rounded edges and Hardcoat Aluminum surface offer a modern style for front-of-the-house applications
- Model widths from 30¼" to 78¼"
- Optional Dark Gray corner caps (black Standard) and Designer Color inset panels available
- 4" legs Standard on 30" and wider models

GR2S-30 with optional Designer Hunter Green inset panels and Accessory pizza pans



### GLO-RAY DESIGNER PORTABLE HEATED SHELVES

Model <sup>®</sup>	Dimensions (W x D x H) Height includes legs	Voltage Single Phase	Watts	Plug	Approx. Ship Weight	List Price
GR2S-24	30¼" x 27" x 4"	120	350	NEMA 5-15P	37 lbs.	<b>\$2428</b>
GR2S-30	36¼" x 27" x 7"	120	450	NEMA 5-15P	40 lbs.	<b>2609</b>
GR2S-36	42¼" x 27" x 7"	120	550	NEMA 5-15P	45 lbs.	<b>2794</b>
GR2S-42	48¼" x 27" x 7"	120	600	NEMA 5-15P	51 lbs.	<b>3083</b>
GR2S-48	54¼" x 27" x 7"	120	700	NEMA 5-15P	56 lbs.	<b>3269</b>
GR2S-54	60¼" x 27" x 7"	120	800	NEMA 5-15P	61 lbs.	<b>3446</b>
GR2S-60	66¼" x 27" x 7"	120	900	NEMA 5-15P	67 lbs.	<b>3631</b>
GR2S-66	72¼" x 27" x 7"	120	1000	NEMA 5-15P	75 lbs.	<b>3811</b>
GR2S-72	78¼" x 27" x 7"	120	1100	NEMA 5-15P	82 lbs.	<b>3995</b>

Ⓜ When no color is specified, color inset panels and corner caps will be black.

#### All Glo-Ray Designer Portable Heated Shelf Models Feature:

- Pan Capacity (12" x 20"): GR2S-24 = 1-pan  
 GR2S-30, -36 = 2-pan  
 GR2S-42, -48 = 3-pan  
 GR2S-54, -60 = 4-pan  
 GR2S-66, -72 = 5-pan

Usable Heated Shelf Space: (Width of unit minus 6⅜") x 21¼"D.

Cord Location: 6' cord and plug located on center of bottom on control side.

#### OPTIONS (available at time of purchase only)

Designer Colors (top surface not painted) – Clear Anodized standard – Non-standard colors are non-returnable –

RED	Warm Red	\$201
BLACK	Black	201
GRAY	Gray Granite	201
WHITE	White Granite	201
NAVY	Navy Blue	201
GREEN	Hunter Green	201
COPPER	Antique Copper	201

Designer Inset Panel colors, GR2S models – Non-standard colors are non-returnable – Black standard –

RED	Warm Red	No Charge
GRAY	Gray Granite	No Charge
WHITE	White Granite	No Charge
NAVY	Navy Blue	No Charge
GREEN	Hunter Green	No Charge
COPPER	Antique Copper	No Charge

Designer Corner Caps, GR2S models – Non-standard colors are non-returnable – Black standard –

DKGRAY	Dark Gray Corner Caps	No Charge
--------	-----------------------	-----------

Hardcoat Aluminum surface in lieu of Stainless Steel on standard 19½" deep GRS models only (please consult factory for pricing of other depths)

HC 18-42	GRS-18 through GRS-42	\$236
HC 48-72	GRS-48 through GRS-72	400
GRS-RECTH	Thermostat Guard (GRS models only)	No Charge



#### ACCESSORIES (available for purchase at any time)

GRS-LEGS	4" Adjustable Legs (GRS models only, standard on units GRS-36 and wider)	\$ 66
2SD-LEGS	4" Adjustable Legs for GR2S-24 (standard on GR2S-30 and wider)	120
GRS-SLANT	Slant Leg Kit for models 12" deep or deeper (GRS models only)	32
<b>Pan Rail for – 19½" deep GRS models only –</b>		
2 RAIL	2-pan	\$208
3 RAIL	3-pan	224
4 RAIL	4-pan	418
5 RAIL	5-pan	433
THRUSHelf	Bolt and fender washer leg accessory kit for attaching one GRS unit to a wire rack shelf	\$15

#### FOOD PANS AND TRIVETS – PAGE 245 COLORS AND FINISHES – INSIDE BACK COVER

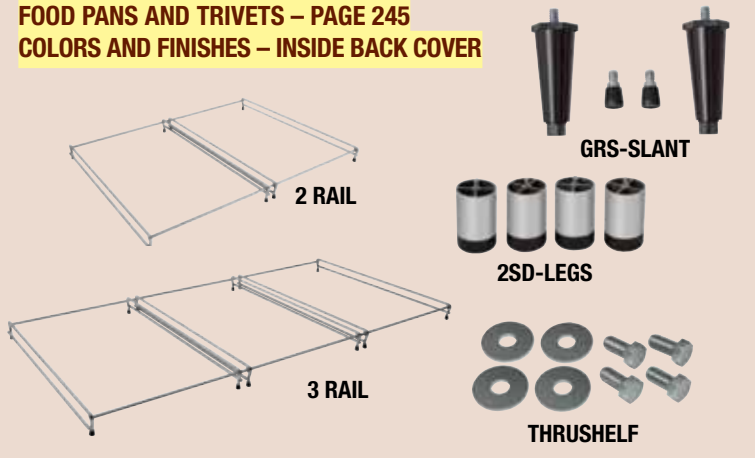

GR 2 S - xx  
 Glo-Ray ————  
 Designer ————  
 Width of Heated Surface (inches)  
 Heated Shelf



## Glo-Ray® Portable Rectangular Heated Simulated Stone Shelves

Match the heat zone to your countertops with Hatco's Glo-Ray® Simulated Stone Portable Rectangular Heated Shelves. These portable foodsafe shelves come in three simulated stone colors and are ideal for buffet lines or as hors d'oeuvre displays. These unique warmers will safely hold food hot while blending in with your décor.

- Made of approved foodsafe materials
- Features a lighted rocker switch and thermostatically-controlled heated base to help hold your food hot and delicious
- Models with simulated stone are Swanstone® and Dekton®



GRSS-3618 in optional Bermuda Sand simulated stone (view of base)

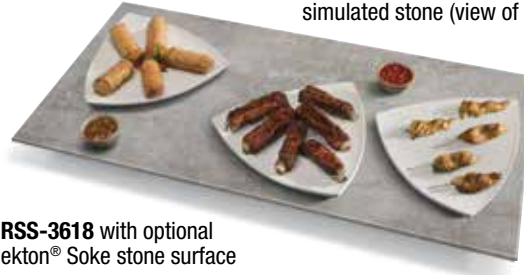

GRSS-3618 with optional Dekton® Soke stone surface

### GLO-RAY SIMULATED STONE PORTABLE RECTANGULAR HEATED SHELVES

Model	Dimensions W x D x H	Voltage Single Phase	Watts	Plug	Approx. Ship Weight	List Price
GRSS-2418	23 <sup>7</sup> / <sub>8</sub> " x 17 <sup>7</sup> / <sub>8</sub> " x 2 <sup>1</sup> / <sub>2</sub> "	120	635	NEMA 5-15P	27 lbs.	<b>\$2042</b>
GRSS-3018	29 <sup>7</sup> / <sub>8</sub> " x 17 <sup>7</sup> / <sub>8</sub> " x 2 <sup>1</sup> / <sub>2</sub> "	120	780	NEMA 5-15P	30 lbs.	<b>2138</b>
GRSS-3618	35 <sup>7</sup> / <sub>8</sub> " x 17 <sup>7</sup> / <sub>8</sub> " x 2 <sup>1</sup> / <sub>2</sub> "	120	930	NEMA 5-15P	35 lbs.	<b>2230</b>
GRSS-4818 <sup>‡</sup>	47 <sup>7</sup> / <sub>8</sub> " x 17 <sup>7</sup> / <sub>8</sub> " x 6 <sup>1</sup> / <sub>4</sub> "	120	1270	NEMA 5-15P	45 lbs.	<b>2420</b>
GRSS-6018 <sup>‡</sup>	59 <sup>7</sup> / <sub>8</sub> " x 17 <sup>7</sup> / <sub>8</sub> " x 6 <sup>1</sup> / <sub>4</sub> "	120	1560	NEMA 5-20P	56 lbs.	<b>3162</b>
GRSS-7218 <sup>‡</sup>	71 <sup>7</sup> / <sub>8</sub> " x 17 <sup>7</sup> / <sub>8</sub> " x 6 <sup>1</sup> / <sub>4</sub> "	120	1860	NEMA 5-20P	68 lbs.	<b>3343</b>

<sup>‡</sup> Height includes standard 4" legs.

All Glo-Ray Simulated Stone Portable Rectangular Heated Shelf Models Feature:  
Cord Location: 6' cord and plug, center of side with switch.

#### OPTIONS (available at time of purchase only)

Simulated stone colors – Non-standard colors are non-returnable – Night Sky standard –

SS-GGRAN	Gray Granite	No Charge
SS-BSAND	Bermuda Sand	No Charge



Dekton® Stone Colors – All Dekton surfaces are non-returnable –

GRSS-2418 – Rectangular Heated Shelves –

DOMOOS	Domoos	\$ 721
REM	Rem	721
SOKE	Soke	721

GRSS-3018 – Rectangular Heated Shelves –

DOMOOS	Domoos	\$ 842
REM	Rem	842
SOKE	Soke	842

GRSS-3618 – Rectangular Heated Shelves –

DOMOOS	Domoos	\$1041
REM	Rem	1041
SOKE	Soke	1041

GRSS-4818 – Rectangular Heated Shelves –

DOMOOS	Domoos	\$1138
REM	Rem	1138
SOKE	Soke	1138

GRSS-6018 – Rectangular Heated Shelves –

DOMOOS	Domoos	\$1371
REM	Rem	1371
SOKE	Soke	1371

GRSS-7218 – Rectangular Heated Shelves –

DOMOOS	Domoos	\$1605
REM	Rem	1605
SOKE	Soke	1605



Dekton® stone surfaces that are available for these models:

Domoos



Rem



Soke



Note: Due to the natural texture, patterns may vary.

#### COLORS AND FINISHES – INSIDE BACK COVER



## Portable Rectangular Heated Base Glass Shelves

The Hatco Heated Base Glass Portable Rectangular Shelves have a heated ceramic glass surface to create uniform heat across the entire surface and are made of approved foodsafe materials. Adjustable thermostatic controls allow surface temperature ranging from 100° to 195°F to be controlled easily.

- Shelves are made of approved foodsafe materials
- Equipped with a Trim Ring that is available in stainless steel (Standard), Designer Black or White
- Lighted On/Off rocker switch
- All units come with a 6' cord and plug
- Surface is made of approved foodsafe materials



**HBG-FS-24** shown with optional Black angled Food Stop (detail view) with **HBG-TRIM-BLK** optional Designer Black trim ring



**HBG-2418** in Standard Black Glass and stainless steel trim ring



**HBG-2418** with optional White Glass, Frame and Trim Ring

### PORTABLE RECTANGULAR HEATED BASE GLASS SHELVES

Model	Dimensions W x D x H	Voltage Single Phase	Watts	Plug	Approx. Ship Weight	List Price
<b>HBG-2418</b>	24 $\frac{3}{8}$ " x 18 $\frac{3}{8}$ " x 2 $\frac{1}{2}$ "	120	425	NEMA 5-15P	29 lbs.	<b>\$2742</b>
<b>HBG-3018</b>	30 $\frac{3}{8}$ " x 18 $\frac{3}{8}$ " x 2 $\frac{1}{2}$ "	120	525	NEMA 5-15P	33 lbs.	<b>2868</b>
<b>HBG-3618</b> †	36 $\frac{3}{8}$ " x 18 $\frac{3}{8}$ " x 6 $\frac{1}{8}$ "	120	630	NEMA 5-15P	36 lbs.	<b>2992</b>
<b>HBG-4818</b> ‡≈	48 $\frac{3}{8}$ " x 18 $\frac{3}{8}$ " x 6 $\frac{1}{8}$ "	120	850	NEMA 5-15P	42 lbs.	<b>3242</b>
<b>HBG-6018</b> ‡≈	60 $\frac{3}{8}$ " x 18 $\frac{3}{8}$ " x 6 $\frac{1}{8}$ "	120	1050	NEMA 5-15P	60 lbs.	<b>3491</b>
<b>HBG-7218</b> ‡≈	72 $\frac{3}{8}$ " x 18 $\frac{3}{8}$ " x 6 $\frac{1}{8}$ "	120	1260	NEMA 5-15P	68 lbs.	<b>3740</b>

† Height includes standard 4" legs.

≈ Units 48" and larger are constructed of two equal sized pieces of glass which create a seam.

**All Portable Rectangular Heated Base Glass Shelf Models Feature:**

Cord Location: 6' cord and plug, center of the side with switch.

#### OPTIONS (available at time of purchase only)

**Ceramic Glass Color – Non-standard colors are non-returnable – Black standard –**  
**HBG-GLASS-WHT** White **No Charge**

**Angled Food Stop keeps product on the heat zone – Choose size/color**

24"	<b>HBG-FS-24</b>	Designer Black	<b>each \$150</b>
30"	<b>HBG-FS-30</b>	Designer Black	<b>each 179</b>
36"	<b>HBG-FS-36</b>	Designer Black	<b>each 208</b>
48"	<b>HBG-FS-48</b>	Designer Black	<b>each 240</b>
60"	<b>HBG-FS-60</b>	Designer Black	<b>each 272</b>
72"	<b>HBG-FS-72</b>	Designer Black	<b>each 306</b>
24"	<b>HBG-FSW-24</b>	White	<b>each \$150</b>
30"	<b>HBG-FSW-30</b>	White	<b>each 179</b>
36"	<b>HBG-FSW-36</b>	White	<b>each 208</b>
48"	<b>HBG-FSW-48</b>	White	<b>each 240</b>
60"	<b>HBG-FSW-60</b>	White	<b>each 272</b>
72"	<b>HBG-FSW-72</b>	White	<b>each 306</b>

**Trim Ring – Stainless Steel standard**

<b>HBG-TRIM-BLK</b>	Designer Black	<b>\$49</b>
<b>HBG-TRIM-WHT</b>	White	<b>49</b>

**Frame (base) color – Non-standard colors are non-returnable – Black standard –**

<b>HBG-FRAME-WHT</b>	White	<b>No Charge</b>
----------------------	-------	------------------

#### COLORS AND FINISHES – INSIDE BACK COVER

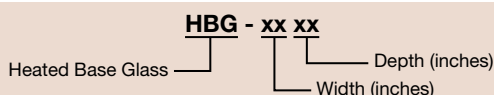



July 1, 2024

## Heated Glass Modular Shelf

Hatco's Heated Glass Modular Shelf creates uniform heat across the entire top surface. The new design uses a modular system, so units can be placed side-by-side. This allows for marvelous flexibility in buffet areas.

- Unit's glass surface accommodates one 12" x 20" food pan
- Thermostatically-controlled with five settings: 130°F, 150°F, 165°F, 185°F and 200°F
- Durable stainless steel housing
- Simple design for easy cleaning and maintenance
- All units come with a 6' cord and plug, located under control side of unit



HGSM-1P

### PORTABLE HEATED GLASS MODULAR SHELF

Model <sup>o</sup>	Dimensions W x D x H	Voltage Single Phase	Watts	Plug	Approx. Ship Weight	List Price
HGSM-1P	15 <sup>3</sup> / <sub>4</sub> " x 23 <sup>3</sup> / <sub>4</sub> " x 2 <sup>5</sup> / <sub>16</sub> "	120	300	NEMA 5-15P	16 lbs.	<b>\$1028</b>

<sup>o</sup> No direct food contact on surface - use pans.

#### All Heated Glass Modular Shelf Models Feature:

**Cord Location:** 6' cord and plug, located under control side of unit.

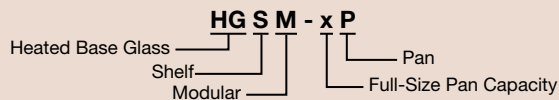



## Glo-Ray® Mini-Merchandisers

Hatco's convenient Glo-Ray® Mini-Merchandisers create impulse sales by placing fresh product in front of customers. Using limited amount of valuable counterspace, these flexible warmers come in a variety of shapes, sizes and colors to hold food samples, hors d'oeuvres and packaged product at just the right temperature.

- Ideal for areas with limited counterspace
- Thermostatically-controlled heated base extends holding times of most foods
- Pre-focused infrared top heat directs heat to the outer edges where heat loss is the greatest
- Food stop, 4" food bins are Standard (GRHW-1SG and -1SGS only)
- Lighted rocker switch for easy On/Off



GRHW-1P with Accessory food pan



GRHW-2P with Standard 4" and Accessory food pans



GRHW-1SG with Standard bins



GRHW-1SGDS in Standard Designer Black

### GLO-RAY MINI-MERCHANDISERS

Model	Description	Dimensions W x D x H Includes sneeze guard	Voltage Single Phase	Watts	Plug	Base/Shelf Dimensions W x D	Approx. Ship Weight	List Price
<b>Single Shelf</b>								
GRHW-1P	Hors d'oeuvres warmer, 2 bulbs	22¼" x 16⅝" x 17¾"	120	820	NEMA 5-15P	21" x 13¾"	35 lbs.	<b>\$2160</b>
GRHW-2P*	Hors d'oeuvres warmer, 4 bulbs	43¼" x 16⅝" x 20¾"	120	1640	NEMA 5-15P	42" x 13¾"	67 lbs.	<b>2870</b>
GRHW-1SG	Single horizontal shelf, 2 bulbs	22¼" x 16⅝" x 17¾"	120	820	NEMA 5-15P	21" x 13¾"	37 lbs.	<b>2587</b>
GRHW-1SGS	Single slanted shelf, 2 bulbs	22¼" x 16⅝" x 18¼"	120	820	NEMA 5-15P	21" x 14¼"	40 lbs.	<b>2588</b>
<b>Dual Shelf</b>								
GRHW-1SGD	Dual shelf, 4 bulbs	22⅞" x 20⅓/16" x 23½"	120	1330	NEMA 5-15P	Bottom: 21" x 13¼" Top: 21" x 14"	40 lbs.	<b>\$4914</b>
GRHW-1SGDS	Hardcoat & slanted base, 4 bulbs	22⅞" x 21" x 23⅝"	120	1330	NEMA 5-15P	Bottom: 21" x 14¼" Top: 21" x 14"	40 lbs.	<b>5132</b>

\* Canada uses 5-20P

#### All Glo-Ray Mini-Merchandiser Models Feature:

Included with Merchandiser: Thermostatically-controlled base, 7½" sneeze guard, display lights, 1" rubber legs (except GRHW-2P has 4" legs), five 4" bins (GRHW-1SG, -1SGS only), 6' cord and plug.

Cord Location: GRHW-1SGD, -1SGDS: Control side, bottom right.

All Other Models: 6' cord and plug, base end plate, same side as switch.

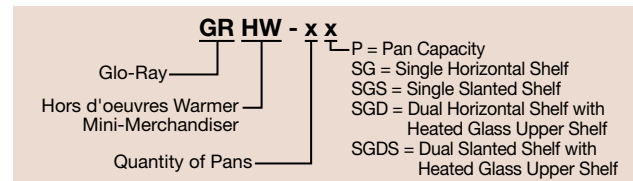

### OPTIONS (available at time of purchase only)

Designer Colors – Non-standard colors are non-returnable – Clear Anodized Aluminum standard – (Designer Color included on GRHW-1SGD, 1SGDS units, Designer Black standard)

RED	Warm Red	\$506
BLACK	Black (standard on GRHW-1SGD, 1SGDS units)	506
GRAY	Gray Granite	506
WHITE	White Granite	506
NAVY	Navy Blue	506
GREEN	Hunter Green	506
COPPER	Antique Copper	506
HAL	60 Watt Halogen Bulb in lieu of standard Display Light	each \$ 69
PANEL	Plexi-Glass Side Panels (GRHW-1P, -2P, -1SG only)	240
1SGD-SLOPE	Sloped Front Sign Holder (GRHW-1SGD, -1SGDS only)	114

### ACCESSORIES (available for purchase at any time)

4"LEGS	4" Adjustable Legs (GRHW-1P, -1SG only) – Standard on GRHW-2P	\$ 66
<b>Chef LED 120V adjustable bulb – bulbs must be rotated down –</b>		
CLED-3000-120	Similar to warm Halogen light	each 139
CLED-4000-120	Similar to cool Fluorescent light	

FOOD PANS AND TRIVETS – PAGE 245  
COLORS AND FINISHES – INSIDE BACK COVER



CLED-3000 and -4000 Accessory



## Glo-Ray® Buffet Warmers

Hold hot food at optimum serving temperatures on buffet lines or at temporary serving areas with Hatco Glo-Ray® Buffet Warmers. Choose from either Standard or Designer style models in many widths to fit your operation.

- Available with Designer Color insets with the choice of an entire unit in color as well
- Thermostatically-controlled heated base of 80°- 200°F extends holding times of most foods
- Pre-focused infrared top heat directs heat to the outer edges where heat loss is greatest
- Sturdy plexi-glass Sneeze Guard
- Shatter-resistant incandescent lights enhance product displays while safeguarding food from bulb breakage
- Available in a variety of widths from 25"-78 1/4"
- Optional infinite control for top heat only



GRBW-30 in optional Designer Navy Blue and Accessory food pans



GR2BW-30 with optional Designer Warm Red inset panels and Accessory food pans



GR2BW-30 in optional Designer Black and plexi-glass side enclosures plus Accessory food pans

### GLO-RAY BUFFET WARMERS

Model	No. of Light Bulbs	Dimensions W x D x H Includes sneeze guard	Maximum Pan Capacity 12" x 20" pan	Voltage	Watts	Plug	Approx. Ship Weight	List Price
GRBW-24	2	25" x 22 1/2" x 17 3/4"	1	120	970	NEMA 5-15P	46 lbs.	\$2306
GRBW-30	2	31" x 22 1/2" x 17 3/4"	2	120	1230	NEMA 5-15P	52 lbs.	2552
GRBW-36	3	37" x 22 1/2" x 20 3/4"	2	120	1530	NEMA 5-15P	58 lbs.	2798
GRBW-42	3	43" x 22 1/2" x 20 3/4"	3	120	1730	NEMA 5-15P	68 lbs.	3044
GRBW-48	4	49" x 22 1/2" x 20 3/4"	3	120	2040	NEMA 5-20P	75 lbs.	3290
GRBW-54	4	55" x 22 1/2" x 20 3/4"	4	120/208-240	2290	NEMA L14-20P	81 lbs.	3536
GRBW-60	5	61" x 22 1/2" x 20 3/4"	4	120/208-240	2600	NEMA L14-20P	90 lbs.	3782
GRBW-66	5	67" x 22 1/2" x 20 3/4"	5	120/208-240	2860	NEMA L14-20P	96 lbs.	4028
GRBW-72	5	73" x 22 1/2" x 20 3/4"	5	120/208-240	3125	NEMA L14-20P	107 lbs.	4274

- ✓ Available in 120/208-240V, NEMA L14-20P.
- ✦ Canadian models use NEMA 5-20P.
- ⊙ Not available in 120V for Canada.

**All Glo-Ray Buffet Warmer Models Feature:**

GRBW base dimensions: 25"-73"W x 19 1/2"D.

Cord Location: 6' cord and plug located on base end plate, same side as switch.

### GLO-RAY DESIGNER BUFFET WARMERS

Model*	No. of Light Bulbs	Dimensions W x D x H Includes sneeze guard	Maximum Pan Capacity 12" x 20" pan	Voltage	Watts	Plug	Approx. Ship Weight	List Price
GR2BW-24	2	30 3/4" x 27" x 19"	1	120	970	NEMA 5-15P	76 lbs.	\$4116
GR2BW-30	2	36 1/4" x 27" x 22"	2	120	1230	NEMA 5-15P	85 lbs.	4504
GR2BW-36	2	42 1/4" x 27" x 22"	2	120	1470	NEMA 5-15P	97 lbs.	4892
GR2BW-42	4	48 1/4" x 27" x 22"	3	120	1790	NEMA 5-15P	110 lbs.	5407
GR2BW-48	4	54 1/4" x 27" x 22"	3	120	2040	NEMA 5-20P	125 lbs.	5922
GR2BW-54	4	60 1/4" x 27" x 22"	4	120	2290	NEMA 5-20P	130 lbs.	6537
GR2BW-60	6	66 1/4" x 27" x 22"	4	120/208-240	2660	NEMA L14-20P	154 lbs.	7152
GR2BW-66	6	72 1/4" x 27" x 22"	5	120/208-240	2920	NEMA L14-20P	169 lbs.	7656
GR2BW-72	6	78 1/4" x 27" x 22"	5	120/208-240	3185	NEMA L14-20P	186 lbs.	8160

- ⊙ When no color is specified, color inset panels and corner caps will be black.
- ✓ Available in 120/208-240V, NEMA L14-20P.
- ✦ Canadian models use NEMA 5-20P.
- ⊙ Not available in 120V for Canada.

**All Glo-Ray Designer Buffet Warmer Models Feature:**

Usable Heated Shelf Space: Width of unit minus 6 1/2" x 21 3/4"D.

Cord Location: 6' cord and plug located on center of bottom on control side.

**OPTIONS AND ACCESSORIES – PAGE 127**

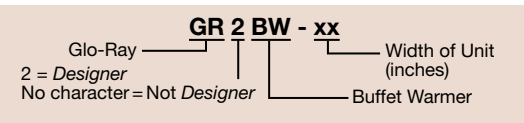



**GRBW-30** with  
Accessory Food Pans

**OPTIONS** (available at time of purchase only)

**Designer Colors – Non-standard colors are non-returnable – Clear Anodized Aluminum standard –**

<b>RED</b>	Warm Red	<b>\$506</b>
<b>BLACK</b>	Black	<b>506</b>
<b>GRAY</b>	Gray Granite	<b>506</b>
<b>WHITE</b>	White Granite	<b>506</b>
<b>NAVY</b>	Navy Blue	<b>506</b>
<b>GREEN</b>	Hunter Green	<b>506</b>
<b>COPPER</b>	Antique Copper	<b>506</b>

**Designer Inset Panel colors, GR2BW models – Non-standard colors are non-returnable – Black standard –**

<b>RED</b>	Warm Red	<b>No Charge</b>
<b>GRAY</b>	Gray Granite	<b>No Charge</b>
<b>WHITE</b>	White Granite	<b>No Charge</b>
<b>NAVY</b>	Navy Blue	<b>No Charge</b>
<b>GREEN</b>	Hunter Green	<b>No Charge</b>
<b>COPPER</b>	Antique Copper	<b>No Charge</b>

**Designer Corner Caps, GR2BW models – Non-standard colors are non-returnable – Black standard –**

<b>DKGRAY</b>	Dark Gray	<b>No Charge</b>
---------------	-----------	------------------

**Plexi-Glass Front and two Side Enclosures in lieu of Sneeze Guards – Available for GRBW-24, -30, -36, -42 and -48 models only –**

<b>FRTENCL-24, -30</b>	-24 and -30 models	<b>\$453</b>
<b>FRTENCL-36, -42, -48</b>	-36, -42, & -48 models	<b>516</b>
<b>SIDE-ENCL</b>	Two Plexi-Glass Side Enclosures (GRBW models only)	<b>308</b>
<b>SIDE-ENCL2</b>	Two Plexi-Glass Side Enclosures (GR2BW models only)	<b>308</b>

**Hardcoat Aluminum Surface, GRBW models –**

<b>HC 24-42</b>	GRBW-24 through GRBW-42	<b>\$161</b>
<b>HC 48-72</b>	GRBW-48 through GRBW-72	<b>322</b>
<b>INF</b>	Infinite Control for top heat only (GRBW-24 through GRBW-60 and GR2BW-24 through GR2BW-60 models only)	<b>\$51</b>
<b>9.375BP</b>	9 3/8" Sneeze Guard in lieu of standard 7 1/2" (GRBW models only)	<b>per foot per side 14</b>
<b>14BP</b>	14" Sneeze Guard in lieu of standard 7 1/2"	<b>per foot per side 28</b>
<b>HAL</b>	60 Watt Halogen Bulb in lieu of standard Display Light	<b>each 69</b>

**ACCESSORIES**

<b>GRBW-LEGS</b>	4" adjustable legs for GRBW-24 models (standard on GRBW-42 or wider)	<b>\$ 66</b>
<b>2SD-LEGS</b>	4" Designer Legs for GR2BW-24 models (standard on GR2BW-30 or wider)	<b>120</b>
<b>Pan Rail for GRBW models (not for use with Plexi-Glass front enclosure)</b>		
<b>2 RAIL</b>	2-pan	<b>\$208</b>
<b>3 RAIL</b>	3-pan	<b>224</b>
<b>4 RAIL</b>	4-pan	<b>418</b>
<b>5 RAIL</b>	5-pan	<b>433</b>
<b>Chef LED 120V adjustable bulb – bulbs must be rotated down –</b>		
<b>CLED-3000-120</b>	Similar to warm Halogen light	<b>each 139</b>
<b>CLED-4000-120</b>	Similar to cool Fluorescent light	

**FOOD PANS AND TRIVETS – PAGE 245**  
**COLORS AND FINISHES – INSIDE BACK COVER**

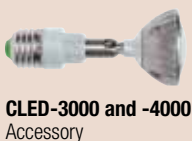



# Built-Ins

*Cafeterias • Buffets*  
*Supermarkets & Delis • Restaurants & Cafés*



**CSSBP-4818** and **CSSBFP-48-S** in standard Night Sky Simulated Stone *pg. 129-130*



**CSBFP-48-S** and **CSUP-48-S** *pg. 131-132*



**HCSSB-3618** with new optional Dekton® Soke stone surface *pg. 143*



**GRSSB-3618** in optional Bermuda Sand simulated stone (shown below an Antique Copper **GR2AHL-42** Strip Heater with optional Sneeze Guards and Designer non-adjustable tubular stands) *pg. 148*



**GRSSB-3618** in standard Night Sky simulated stone built into a granite countertop *pg. 148*



**HBGB-3618** in standard Black Glass (shown below a **GR2AHL-42** Strip Heater with Designer non-adjustable tubular stands, optional Sneeze Guards) *pg. 149*



**HBGB-3618** with optional Trim Ring in new optional White Glass *pg. 149*



**GRSB-54-I** (Hardcoat Aluminum) and accessory food pans (shown below a **GRAL-96D** Strip Heater with optional Sneeze Guards) *pg. 150*



**GRSBF-60-O** (Anodized Aluminum) built into a simulated stone countertop with accessory food pans, (shown below a **GR2AL-96D** Strip Heater in Designer Black with optional Sneeze Guards) *pg. 152*



## R-290 Cold Built-In Simulated Stone Shelves

Hatco's R-290 Cold Simulated Stone Shelves Built-In are an environmentally friendly solution to keep food cold on buffet lines in cafeterias, restaurants and much more!



- Keeps food cold using environmentally friendly R-290 refrigerant
- Patented thermal break reduces condensation and temperature transfer on adjacent surfaces
- All models are bottom mount units
- Simulated stone is Swanstone®
- Control Box comes with standard 4' lead wire
- All models match the GRSSB Glo-Ray® Built-In Heated Simulated Stone Shelves
- Condenser utilizes an environmentally friendly R-290 refrigerant, which has a 90% higher heat absorption capacity than other refrigerants, resulting in quicker temperature recovery and lower energy consumption

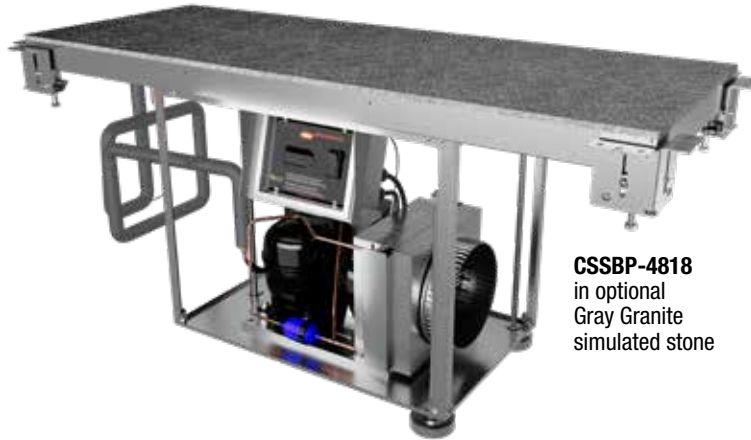

**CSSBP-4818**  
in optional  
Gray Granite  
simulated stone

### R-290 COLD BUILT-IN SIMULATED STONE SHELVES (flush to countertop)

Model	Overall Shelf Dimensions (includes brackets) W x D		Shelf Space W x D	Voltage			Comp. Size HP	Approx. Ship Weight	List Price
	W	D		Single Phase	Watts	Hz			
<b>CSSBP-2418</b>	27"	21"	24" x 18"	120	345	60	1/5	126 lbs.	<b>\$8016</b>
<b>CSSBP-3018</b>	33"	21"	30" x 18"	120	345	60	1/5	132 lbs.	<b>8346</b>
<b>CSSBP-3618</b>	39"	21"	36" x 18"	120	345	60	1/5	145 lbs.	<b>8481</b>
<b>CSSBP-4818</b>	51"	21"	48" x 18"	120	440	60	1/3	172 lbs.	<b>9746</b>

All R-290 Cold Built-In Simulated Stone Shelf Models Feature:

Models Shipped with: Electronic Temperature Control and a condensing unit, 6' cord and plug (NEMA 5-15P).

### OPTIONS

(available at time of purchase only)

Simulated stone colors –  
Non-standard colors are non-returnable – Night Sky standard –

<b>SS-GGRAN</b> Gray Granite	<b>No Charge</b>
<b>SS-BSAND</b> Bermuda Sand	<b>No Charge</b>

**COLORS AND FINISHES – INSIDE BACK COVER OF CURRENT PRICE LIST**

### COUNTERTOP CUTOUT DIMENSIONS

Model	Width with 3/8" corner radii	Depth with 3/8" corner radii
<b>CSSBP-2418</b>	24 3/8"	18 3/8"
<b>CSSBP-3018</b>	30 3/8"	18 3/8"
<b>CSSBP-3618</b>	36 3/8"	18 3/8"
<b>CSSBP-4818</b>	48 3/8"	18 3/8"

**NOTE:** The installation kit, including the intake bracket, duct clamp, flexible duct, and duct collar, will be shipped separately.

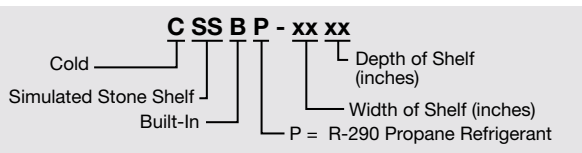



July 1, 2024

## R-290 Cold Built-In Flush Top Simulated Stone Shelves

Hatco's new R-290 Cold Built-In Flush Top Simulated Stone Shelves are a must for buffet lines in cafeterias, restaurants and more!

- Condenser utilizes environmentally friendly R-290 refrigerant
- Patented thermal break reduces condensation and temperature transfer on adjacent surfaces
- All models are bottom mount units
- Control Box can be mounted 4' from center of the shelf
- Simulated stone is Swanstone®

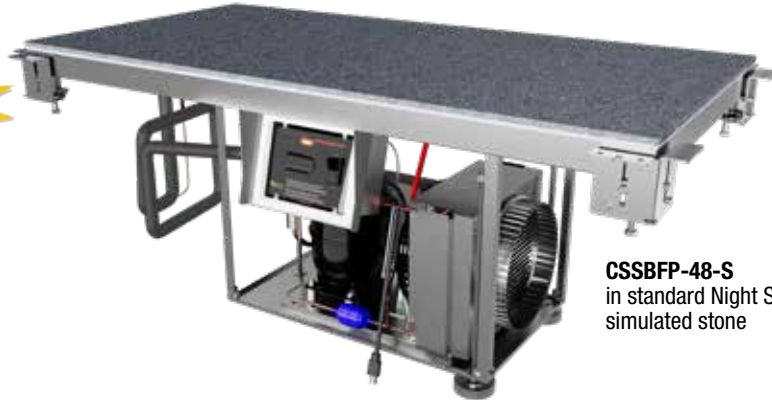

**CSSBFP-48-S**  
in standard Night Sky simulated stone

### R-290 COLD BUILT-IN FLUSH TOP SIMULATED STONE SHELVES

Model	Overall Shelf Dimensions (includes brackets) W x D	Shelf Space W x D	Voltage		Comp. Size HP	Approx. Ship Weight	List Price	
			Single Phase	Watts				
CSSBFP-24-F	27" x 18½"	24" x 15½"	120	345	60	1/5	119 lbs.	<b>\$ 7636</b>
CSSBFP-24-I	27" x 22½"	24" x 19½"	120	345	60	1/5	124 lbs.	<b>8162</b>
CSSBFP-24-S	27" x 27"	24" x 24"	120	345	60	1/5	134 lbs.	<b>8650</b>
CSSBFP-36-F	39" x 18½"	36" x 15½"	120	345	60	1/5	138 lbs.	<b>8312</b>
CSSBFP-36-I	39" x 22½"	36" x 19½"	120	440	60	1/3	155 lbs.	<b>8710</b>
CSSBFP-36-S	39" x 27"	36" x 24"	120	440	60	1/3	164 lbs.	<b>9869</b>
CSSBFP-48-F	51" x 18½"	48" x 15½"	120	440	60	1/3	159 lbs.	<b>9002</b>
CSSBFP-48-I	51" x 22½"	48" x 19½"	120	440	60	1/3	171 lbs.	<b>9653</b>
CSSBFP-48-S	51" x 27"	48" x 24"	120	560	60	1/2	189 lbs.	<b>11596</b>

**All Cold Built-In Flush Top Simulated Stone Shelf Models Feature:**

Electronic Temperature Control and a condensing unit, 6' cord and plug (NEMA 5-15P).

#### OPTIONS (available at time of purchase only)

Simulated stone colors – Non-standard colors are non-returnable – Night Sky standard –

SS-GGRAN	Gray Granite	No Charge
SS-BSAND	Bermuda Sand	No Charge
EWC	(Additional four year extended Parts Only Warranty on the compressor available at the time of unit purchase CSSB, CSSBR models only)	<b>\$200</b>

#### COLORS AND FINISHES – INSIDE BACK COVER OF CURRENT PRICE LIST

#### COUNTERTOP CUTOUT DIMENSIONS

Model	Width with ⅜" corner radii	Depth with ⅜" corner radii
CSSBFP-24-F	24 ⅜"	15 ⅞"
CSSBFP-24-I	24 ⅜"	19 ⅞"
CSSBFP-24-S	24 ⅜"	24 ⅜"
CSSBFP-36-F	36 ⅜"	15 ⅞"
CSSBFP-36-I	36 ⅜"	19 ⅞"
CSSBFP-36-S	36 ⅜"	24 ⅜"
CSSBFP-48-F	48 ⅜"	15 ⅞"
CSSBFP-48-I	48 ⅜"	19 ⅞"
CSSBFP-48-S	48 ⅜"	24 ⅜"

**NOTE:** The installation kit, including the intake bracket, duct clamp, flexible duct, and duct collar, will be shipped separately.

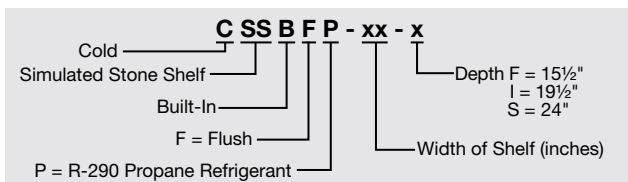

## R-290 Cold Built-In Flush Top Shelves

Hatco's R-290 Cold Shelves Built-In Flush Top, in our signature Hardcoat Aluminum, are designed to keep your pre-chilled beverages, hors d'oeuvres, side dishes, buffet items and more, perfectly chilled.

- Condenser utilizes environmentally friendly R-290 refrigerant
- Patented thermal break reduces condensation and temperature transfer on adjacent surfaces
- All models are top mounted with an Hardcoat Aluminum surface
- All models match the GRSBF Heated Built-In Shelves for a fully integrated look
- Control Box comes standard with a 4' lead wire
- Condenser utilizes an environmentally friendly R-290 refrigerant, which has a 90% higher heat absorption capacity than other refrigerants, resulting in quicker temperature recovery and lower energy consumption



**CSBFP-48-S**  
(Flush Top)

### R-290 COLD BUILT-IN FLUSH TOP SHELVES (Hardcoat Aluminum)

Model	Overall Shelf Dimensions W x D	Usable Shelf Space W x D	Voltage		Comp. Size		Approx. Ship Weight	List Price
			Single Phase	Watts	HP	Hz		
CSBFP-24-F	25½" x 17"	24" x 15½"	120	345	1/5	60	108 lbs.	\$ 6909
CSBFP-24-I	25½" x 21"	24" x 19½"	120	345	1/5	60	116 lbs.	7199
CSBFP-24-S	25½" x 25½"	24" x 24"	120	345	1/5	60	117 lbs.	7493
CSBFP-36-F	37½" x 17"	36" x 15½"	120	345	1/5	60	130 lbs.	7388
CSBFP-36-I	37½" x 21"	36" x 19½"	120	440	1/3	60	130 lbs.	7965
CSBFP-36-S	37½" x 25½"	36" x 24"	120	440	1/3	60	151 lbs.	8359
CSBFP-48-F	49½" x 17"	48" x 15½"	120	440	1/3	60	138 lbs.	8172
CSBFP-48-I	49½" x 21"	48" x 19½"	120	440	1/3	60	157 lbs.	8567
CSBFP-48-S	49½" x 25½"	48" x 24"	120	560	1/2	60	177 lbs.	9265

**All R-290 Cold Built-In Flush Top Shelf Models Feature:**  
Electronic Temperature Control and a condensing unit, 6' cord and plug (NEMA 5-15P).

### COUNTERTOP CUTOUT DIMENSIONS

Model	Width		Depth	
	Min	Max	Min	Max
CSBFP-24-F	24 <sup>5</sup> / <sub>8</sub> "	25"	16 <sup>1</sup> / <sub>8</sub> "	16½"
CSBFP-24-I	24 <sup>5</sup> / <sub>8</sub> "	25"	20 <sup>1</sup> / <sub>8</sub> "	20½"
CSBFP-24-S	24 <sup>5</sup> / <sub>8</sub> "	25"	24 <sup>5</sup> / <sub>8</sub> "	25"
CSBFP-36-F	36 <sup>5</sup> / <sub>8</sub> "	37"	16 <sup>1</sup> / <sub>8</sub> "	16½"
CSBFP-36-I	36 <sup>5</sup> / <sub>8</sub> "	37"	20 <sup>1</sup> / <sub>8</sub> "	20½"
CSBFP-36-S	36 <sup>5</sup> / <sub>8</sub> "	37"	24 <sup>5</sup> / <sub>8</sub> "	25"
CSBFP-48-F	48 <sup>5</sup> / <sub>8</sub> "	49"	16 <sup>1</sup> / <sub>8</sub> "	16½"
CSBFP-48-I	48 <sup>5</sup> / <sub>8</sub> "	49"	20 <sup>1</sup> / <sub>8</sub> "	20½"
CSBFP-48-S	48 <sup>5</sup> / <sub>8</sub> "	49"	24 <sup>5</sup> / <sub>8</sub> "	25"

### OPTIONS (available at time of purchase only)

**EWC** (Additional four year extended Parts Only Warranty on the compressor available at the time of unit purchase CSSB, CSSBR models only) **\$200**

**NOTE:** The installation kit, including the intake bracket, duct clamp, flexible duct, and duct collar, will be shipped separately.

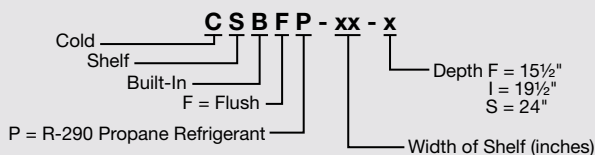



July 1, 2024

## R-290 Cold Undermount Shelves

R-290 Cold Undermount Shelves use environmentally friendly R-290 refrigerant to provide a cold surface like the Cold Built-in Flush Top Shelves, but are mounted directly against the underside of a granite, quartz, Stainless Steel or appropriate solid surface counter top. Cooling transfers through the countertop with a seamless look.

- Condenser utilizes environmentally friendly R-290 refrigerant
- Mounts directly to underside of appropriate countertop material
- Condenser utilizes an environmentally friendly R-290 refrigerant, which has a 90% higher heat absorption capacity than other refrigerants, resulting in quicker temperature recovery and lower energy consumption
- Approved materials include granite and quartz up to 1 3/16", Swanstone® (provided by Hatco), and certain Stainless Steel or aluminum surfaces approved by Hatco. Please contact the factory for applications with other materials \*
- All models feature an anodized aluminum surface
- Control Box comes standard with a 4' lead wire

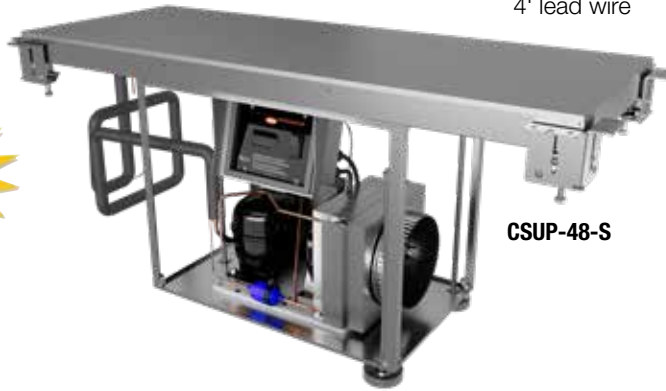

CSUP-48-S

### R-290 COLD UNDERMOUNT SHELVES (Anodized Aluminum)

Model #	Overall Shelf Dimensions (includes brackets) W x D	Usable Shelf Space W x D	Watts 120V Single Phase	Hz	Compressor Size HP	Approx. Ship Weight	List Price
CSUP-24-F	27 5/16" x 18 13/16"	24" x 15 1/2"	345	60	1/5	115 lbs.	\$ 6735
CSUP-24-I	27 5/16" x 22 13/16"	24" x 19 1/2"	345	60	1/5	118 lbs.	6955
CSUP-24-S	27 5/16" x 27 5/16"	24" x 24"	345	60	1/5	130 lbs.	7481
CSUP-36-F	39 5/16" x 18 13/16"	36" x 15 1/2"	345	60	1/5	143 lbs.	7046
CSUP-36-I	39 5/16" x 22 13/16"	36" x 19 1/2"	440	60	1/3	140 lbs.	7479
CSUP-36-S	39 5/16" x 27 5/16"	36" x 24"	440	60	1/3	125 lbs.	7751
CSUP-48-F	51 5/16" x 18 13/16"	48" x 15 1/2"	440	60	1/3	141 lbs.	7629
CSUP-48-I	51 5/16" x 22 13/16"	48" x 19 1/2"	440	60	1/3	144 lbs.	7801
CSUP-48-S	51 5/16" x 27 5/16"	48" x 24"	560	60	1/2	178 lbs.	8581



CSUP models include thermal mastic caulk and a single use applicator

**All Cold Undermount Shelf Models Feature:**

**Models Shipped with:** Electronic Temperature Control and a condensing unit, 6' cord and plug (NEMA 5-15P), thermal mastic caulk and single use applicator.

### COUNTERTOP CUTOUT DIMENSIONS

Model	Width with 3/8" corner radii	Depth with 3/8" corner radii
CSUP-24-F	24 3/8"	15 7/8"
CSUP-24-I	24 3/8"	19 7/8"
CSUP-24-S	24 3/8"	24 3/8"
CSUP-36-F	36 3/8"	15 7/8"
CSUP-36-I	36 3/8"	19 7/8"
CSUP-36-S	36 3/8"	24 3/8"
CSUP-48-F	48 3/8"	15 7/8"
CSUP-48-I	48 3/8"	19 7/8"
CSUP-48-S	48 3/8"	24 3/8"

### OPTIONS (available at time of purchase only)

**EWC** (Additional four year extended Parts Only Warranty on the compressor available at the time of unit purchase CSSB, CSSBR models only) **\$200**

**NOTE:** The installation kit, including the intake bracket, duct clamp, flexible duct, and duct collar, will be shipped separately.

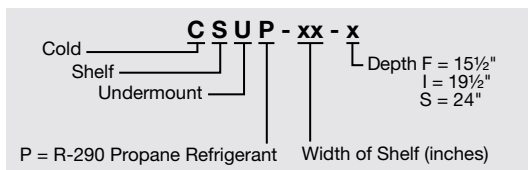



## Built-In Flush Mount Ceramic Glass Heated Shelves

Give your operation a seamless look with the Built-In Flush Mount Ceramic Glass Heated Shelf. The bracket mounting hardware gives a true flush mount appearance that will safely hold food hot while blending with your decor. It is a must for buffet lines in cafeterias, restaurants and more!

- Standard Black or optional white Ceramic Glass surface
- All models have a Ceramic Glass surface and are bottom mount, flush with the countertop
- Blanket-type element with thermostatically-controlled heated base results in uniform heat to extend food holding times
- Insulation keeps heat at the holding surface while a built-in adjustable thermostat controls surface temperature.
- Standard control includes thermostat, lighted rocker switch and mounting brackets
- 3' Conduit is standard – Option: with ITC Control Boxes only, 6' and 10' lengths are available



**HSBF-GL-4818**  
in standard  
Black Glass



**HSBF-GL-4818**  
in optional  
White Glass

### BUILT-IN FLUSH TOP CERAMIC GLASS HEATED SHELVES

Model <sup>M</sup>	Overall Shelf Dimensions (includes brackets) W x D x H	Heated Shelf Space W x D	Cutout Size (with 3/8" corner radii) W x D	Voltage Single Phase	Watts	Amps	List Price
<b>HSBF-GL-2418</b>	27" x 21 1/8" x 5 1/2"	24" x 18"	24 1/4" x 18 3/8"	120	425	3.5	<b>\$2986</b>
<b>HSBF-GL-3018</b>	33" x 21 1/8" x 5 1/2"	30" x 18"	30 1/4" x 18 3/8"	120	525	4.4	<b>3112</b>
<b>HSBF-GL-3618</b>	39" x 21 1/8" x 5 1/2"	36" x 18"	36 1/4" x 18 3/8"	120	630	5.3	<b>3245</b>
<b>HSBF-GL-4818</b>	51" x 21 1/8" x 5 1/2"	48" x 18"	48 1/4" x 18 3/8"	120	850	7.1	<b>3556</b>

<sup>M</sup> Recommended for use in a metallic countertop. For other surfaces, verify that the material is suitable for temperatures up to 200°F. Hatco is not responsible for counter damage caused by heat from the warmer.

#### All Built-In Flush Mount Ceramic Glass Heated Shelf Models Feature:

**Control Box:** Flush Mount Electronic Temperature Control with 3' conduit

**Cord Location:** Cord is attached to Control Box.

**Cord and Plug:** 6' cord and plug (NEMA 5-15P).

**NOTE:** Install Remote Box outside Heat Zone or damage will occur.

### OPTIONS (available at time of purchase only)

<b>Ceramic Glass Color – Black standard –</b>		<b>No Charge</b>
<b>HSBF-GLASS-WHT</b>	White	
<b>Designer Color for Flush Mount Control Bezel – Stainless Steel standard – Non-standard colors are non-returnable</b>		
<b>RED</b>	Warm Red	<b>\$ 47</b>
<b>BLACK</b>	Black	<b>47</b>
<b>GRAY</b>	Gray Granite	<b>47</b>
<b>WHITE</b>	White Granite	<b>47</b>
<b>NAVY</b>	Navy Blue	<b>47</b>
<b>GREEN</b>	Hunter Green	<b>47</b>
<b>COPPER</b>	Antique Copper	<b>47</b>
<b>HSBF-FLUSH-ITC</b>	Stainless steel Flush Mount Recessed Electronic Control Box with lighted On/Off rocker switch and angled recessed controls (6 7/16"W x 7 13/16"H x 5 9/32"D)	<b>202</b>
<b>HSBF-SMFLUSH-ITC</b>	Flush Mount Electronic Control Box with lighted On/Off rocker switch (8 1/2"W x 4"H x 3 13/16"D)	<b>202</b>
<b>HSBF-FLUSH-TSTAT</b>	Stainless steel Flush Mount Recessed Thermostatic Control Box with lighted On/Off rocker switch and angled recessed controls (6 7/16"W x 7 13/16"H x 4 17/32"D)	<b>No Charge</b>
<b>HSBF-SMFLUSH-TSTAT</b>	Flush Mount Thermostatic Control Box with lighted On/Off rocker switch (8 1/2"W x 3 11/16"H x 3 13/16"D)	<b>No Charge</b>
<b>COND-6</b>	6' Conduit (3' standard) – used with Flush Mount and Small Flush Mount ITC Control Boxes only)	<b>46</b>
<b>COND-10</b>	10' Conduit (3' standard) (used with Flush Mount and Small Flush Mount ITC Control Boxes only)	<b>89</b>

### COLORS AND FINISHES – INSIDE BACK COVER



**HSBF-FLUSH-ITC**



**HSBF-FLUSH-TSTAT**



**HSBF-SMFLUSH-ITC**



**HSBF-SMFLUSH-TSTAT**

### OPTIONAL CONTROL BOX CUTOUT DIMENSIONS

Model	Width	Height	Depth
<b>HSBF-FLUSH-ITC</b>	5 7/8"	6 3/8"	4 5/8"
<b>HSBF-FLUSH-TSTAT</b>	5 7/8"	6 3/8"	4"
<b>HSBF-SMFLUSH-ITC</b>	6 3/4"	3 3/4"	3 3/8"
<b>HSBF-SMFLUSH-TSTAT</b>	6 3/4"	3 3/8"	3 25/64"

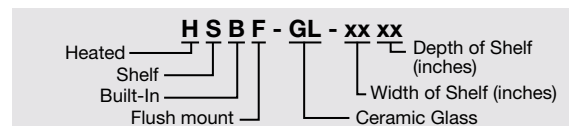



## Built-In Flush Mount Hardcoat Aluminum Heated Shelves

Give your operation a seamless look with the Built-In Flush Mount Hardcoat Aluminum Heated Shelf. The bracket mounting hardware gives a true flush mount appearance that will safely hold food hot while blending with your decor. It is a must for buffet lines in cafeterias, restaurants and more!

- All models have a Hardcoat Aluminum surface and are bottom mount, flush with the countertop
- Blanket-type element with thermostatically-controlled heated base results in uniform heat to extend food holding times.
- Insulation keeps heat at the holding surface while a built-in adjustable thermostat controls surface temperature
- Standard control includes thermostat, lighted rocker switch and mounting brackets
- 3' Conduit is standard – Option: with ITC Control Boxes only, 6' and 10' lengths are available

**NOTE:** Install Remote Box outside Heat Zone or damage will occur.



HSBF-HC-4818

### BUILT-IN FLUSH MOUNT HARDCOAT ALUMINUM HEATED SHELVES

Model <sup>M</sup>	Overall Shelf Dim. (includes brackets) W x D x H	Heated Shelf Space W x D	Cutout Size (with 3/8" corner radii) W x D	Voltage Single Phase	Watts	Amps	List Price
HSBF-HC-2418	27 1/8" x 21 1/8" x 5 11/32"	24" x 18"	24 3/8" x 18 3/8"	120	425	3.5	<b>\$1841</b>
HSBF-HC-2424	27 1/8" x 27 1/8" x 5 11/32"	24" x 24"	24 3/8" x 24 3/8"	120	680	5.7	<b>1848</b>
HSBF-HC-2430	27 1/8" x 33 1/8" x 5 11/32"	24" x 30"	24 3/8" x 30 3/8"	120	790	6.6	<b>2007</b>
HSBF-HC-3018	33 1/8" x 21 1/8" x 5 11/32"	30" x 18"	30 3/8" x 18 3/8"	120	525	4.4	<b>1961</b>
HSBF-HC-3024	33 1/8" x 27 1/8" x 5 11/32"	30" x 24"	30 3/8" x 24 3/8"	120	815	6.8	<b>1969</b>
HSBF-HC-3030	33 1/8" x 33 1/8" x 5 11/32"	30" x 30"	30 3/8" x 30 3/8"	120	950	7.9	<b>2185</b>
HSBF-HC-3618	39 1/8" x 21 1/8" x 5 11/32"	36" x 18"	36 3/8" x 18 3/8"	120	630	5.3	<b>2085</b>
HSBF-HC-3624	39 1/8" x 27 1/8" x 5 11/32"	36" x 24"	36 3/8" x 24 3/8"	120	950	7.9	<b>2094</b>
HSBF-HC-3630	39 1/8" x 33 1/8" x 5 11/32"	36" x 30"	36 3/8" x 30 3/8"	120	1110	9.3	<b>2433</b>
HSBF-HC-4218	45 1/8" x 21 1/8" x 5 11/32"	42" x 18"	42 3/8" x 18 3/8"	120	735	6.1	<b>2188</b>
HSBF-HC-4224	45 1/8" x 27 1/8" x 5 11/32"	42" x 24"	42 3/8" x 24 3/8"	120	1090	9.1	<b>2199</b>
HSBF-HC-4230	45 1/8" x 33 1/8" x 5 11/32"	42" x 30"	42 3/8" x 30 3/8"	120	1270	10.6	<b>2672</b>
HSBF-HC-4818	51 1/8" x 21 1/8" x 5 11/32"	48" x 18"	48 3/8" x 18 3/8"	120	850	7.1	<b>2305</b>
HSBF-HC-4824	51 1/8" x 27 1/8" x 5 11/32"	48" x 24"	48 3/8" x 24 3/8"	120	1225	10.2	<b>2316</b>
HSBF-HC-4830	51 1/8" x 33 1/8" x 5 11/32"	48" x 30"	48 3/8" x 30 3/8"	120	1430	11.9	<b>2879</b>

<sup>M</sup> Recommended for use in a metallic countertop. For other surfaces, verify that the material is suitable for temperatures up to 200°F. Hatco is not responsible for counter damage caused by heat from the warmer.

#### All Built-In Flush Mount Hardcoat Aluminum Heated Shelf Models Feature:

- Control Box: Flush Mount Electronic Temperature Control with 3' conduit.
- Cord Location: Cord is attached to Control Box.
- Cord and Plug: 6' cord and plug (NEMA 5-15P).

#### OPTIONS (available at time of purchase only)

Designer Color for Flush Mount Control Bezel – Stainless Steel standard – Non-standard colors are non-returnable –

Color	Description	Price
RED	Warm Red	\$ 47
BLACK	Black	47
GRAY	Gray Granite	47
WHITE	White Granite	47
NAVY	Navy Blue	47
GREEN	Hunter Green	47
COPPER	Antique Copper	47

HSBF-FLUSH-ITC	Stainless steel Flush Mount Recessed Electronic Control Box with lighted On/Off rocker switch and angled recessed controls (6 7/16" W x 7 13/16" H x 5 9/32" D)	202
HSBF-SMFLUSH-ITC	Flush Mount Electronic Control Box with lighted On/Off rocker switch (8 1/2" W x 4" H x 3 13/16" D)	202
HSBF-FLUSH-TSTAT	Stainless steel Flush Mount Recessed Thermostatic Control Box with lighted On/Off rocker switch and angled recessed controls (6 7/16" W x 7 13/16" H x 4 17/32" D)	No Charge
HSBF-SMFLUSH-TSTAT	Flush Mount Thermostatic Control Box with lighted On/Off rocker switch (8 1/2" W x 3 11/16" H x 3 15/16" D)	No Charge
COND-6	6' Conduit (3' standard) – used with Flush Mount and Small Flush Mount ITC Control Boxes only)	46
COND-10	10' Conduit (3' standard) (used with Flush Mount and Small Flush Mount ITC Control Boxes only)	89

#### COLORS AND FINISHES – INSIDE BACK COVER

#### OPTIONAL CONTROL BOX CUTOUT DIMENSIONS

Model	Width	Height	Depth
HSBF-FLUSH-ITC	5 5/8"	6 3/8"	4 1/8"
HSBF-FLUSH-TSTAT	5 5/8"	6 3/8"	4"
HSBF-SMFLUSH-ITC	6 3/4"	3 3/4"	3 5/8"
HSBF-SMFLUSH-TSTAT	6 3/4"	3 1/8"	3 25/64"



HSBF-FLUSH-ITC



HSBF-FLUSH-TSTAT



HSBF-SMFLUSH-ITC



HSBF-SMFLUSH-TSTAT

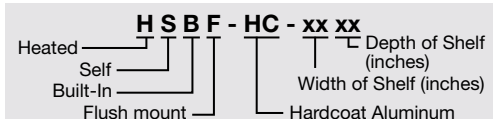

## Built-In Flush Mount Simulated Stone Heated Shelves

Give your operation a seamless look with the Built-In Flush Mount Simulated Stone Heated Shelf. The bracket mounting hardware gives a true flush mount appearance that will safely hold food hot while blending with your decor. It is a must for buffet lines in cafeterias, restaurants and more!

**HSBF-SS-4818**  
in standard Night Sky



- The Simulated Stone unit mounts directly to underside of appropriate countertop material
- Simulated stone is Swanstone®
- Blanket-type element with thermostatically-controlled heated base results in uniform heat to extend food holding times

- Insulation keeps heat at the holding surface while a built-in adjustable thermostat controls surface temperature.
- Standard control includes thermostat, lighted rocker switch and mounting brackets
- 3' Conduit is standard – Option: with ITC Control Boxes only, 6' and 10' lengths are available



**HSBF-SS-4818**  
in optional  
Gray Granite

**HSBF-SS-4818**  
in optional  
Bermuda Sand



### BUILT-IN FLUSH MOUNT SIMULATED STONE HEATED SHELVES

Model <sup>M</sup>	Overall Shelf Dimensions (includes brackets) W x D x H	Heated Shelf Space W x D	Cutout Size (with 3/8" corner radii) W x D	Voltage Single Phase	Watts	Amps	List Price
<b>HSBF-SS-2418</b>	27" x 21 x 5 5/8"	24" x 18"	24 3/8" x 18 3/8"	120	635	5.3	<b>\$2203</b>
<b>HSBF-SS-3018</b>	33" x 21 x 5 5/8"	30" x 18"	30 3/8" x 18 3/8"	120	780	6.5	<b>2293</b>
<b>HSBF-SS-3618</b>	39" x 21 x 5 5/8"	36" x 18"	36 3/8" x 18 3/8"	120	930	7.8	<b>2390</b>
<b>HSBF-SS-4818</b>	51" x 21 x 5 5/8"	48" x 18"	48 3/8" x 18 3/8"	120	1270	10.6	<b>2709</b>

<sup>M</sup> Recommended for use in a metallic countertop. For other surfaces, verify that the material is suitable for temperatures up to 200°F. Hatco is not responsible for counter damage caused by heat from the warmer.

#### All Built-In Flush Mount Simulated Stone Heated Shelf Models Feature

**Control Box:** Flush Mount Electronic Temperature Control with 3' conduit.

**Cord Location:** Cord is attached to Control Box.

**Cord and Plug:** 6' cord and plug (NEMA 5-15P).

**NOTE:** Install Remote Box outside Heat Zone or damage will occur.

#### OPTIONS (available at time of purchase only)

**Simulated stone colors – Non-standard colors are non-returnable – Night Sky standard –**

<b>SS-GGRAN</b>	Gray Granite	<b>No Charge</b>
<b>SS-BSAND</b>	Bermuda Sand	<b>No Charge</b>

**Designer Color for Flush Mount Control Bezel – Stainless Steel standard – Non-standard colors are non-returnable**

<b>RED</b>	Warm Red	<b>\$ 47</b>
<b>BLACK</b>	Black	<b>47</b>
<b>GRAY</b>	Gray Granite	<b>47</b>
<b>WHITE</b>	White Granite	<b>47</b>
<b>NAVY</b>	Navy Blue	<b>47</b>
<b>GREEN</b>	Hunter Green	<b>47</b>
<b>COPPER</b>	Antique Copper	<b>47</b>

**HSBF-FLUSH-ITC** Stainless steel Flush Mount Recessed Electronic Control Box with lighted On/Off rocker switch and angled recessed controls (6 7/16"W x 7 13/16"H x 5 3/32"D) **202**

**HSBF-SMFLUSH-ITC** Flush Mount Electronic Control Box with lighted On/Off rocker switch (8 1/2"W x 4"H x 3 13/16"D) **202**

**HSBF-FLUSH-TSTAT** Stainless steel Flush Mount Recessed Thermostatic Control Box with lighted On/Off rocker switch and angled recessed controls (6 7/16"W x 7 13/16"H x 4 17/32"D) **No Charge**

**HSBF-SMFLUSH-TSTAT** Flush Mount Thermostatic Control Box with lighted On/Off rocker switch (8 1/2"W x 3 11/16"H x 3 15/16"D) **No Charge**

**COND-6** 6' Conduit (3' standard) – used with Flush Mount and Small Flush Mount ITC Control Boxes only **\$46**

**COND-10** 10' Conduit (3' standard) (used with Flush Mount and Small Flush Mount ITC Control Boxes only) **89**

#### COLORS AND FINISHES – INSIDE BACK COVER

#### OPTIONAL CONTROL BOX CUTOUT DIMENSIONS

Model	Width	Height	Depth
<b>HSBF-FLUSH-ITC</b>	5 7/8"	6 3/8"	4 7/8"
<b>HSBF-FLUSH-TSTAT</b>	5 7/8"	6 3/8"	4"
<b>HSBF-SMFLUSH-ITC</b>	6 3/4"	3 3/4"	3 5/8"
<b>HSBF-SMFLUSH-TSTAT</b>	6 3/4"	3 3/8"	3 25/64"



**HSBF-FLUSH-ITC**



**HSBF-FLUSH-TSTAT**



**HSBF-SMFLUSH-ITC**



**HSBF-SMFLUSH-TSTAT**





July 1, 2024

## Cold Built-In Simulated Stone Shelves

Hatco's Cold Built-In Simulated Stone Shelves are a must for buffet lines in cafeterias, restaurants and much more!

CSSBR and CSSBX have benefit of allowing fabricators the freedom to design.

- Patented thermal break reduces condensation and temperature transfer on adjacent surfaces
- All models are bottom mount units
- Simulated stone is Swanstone®
- All models match the GRSSB Heated Simulated Stone Built-In Shelves for a fully integrated look
- Control Box comes with standard 4' lead wire
- Control Box can be mounted 4' from center of the shelf (CSSB models only)

- Condensing unit may be mounted up to 4' away from center of shelf (CSSB models only)
- Condensing unit features easy serviceability with sight glass, service valves, dryer/filter and receiver (CSSB, CSSBR models only)
- CSSB models offer a long, flexible, refrigerant line which allows condensing unit to be pulled out for service
- CSSBR models have unattached Condensing unit and Control Box, CSSBX models have unattached Control Box only



**CSSB-4818**  
in optional Bermuda Sand simulated stone



**CSSBR-4818**  
in standard Night Sky simulated stone – All models come with unattached Condenser and Control Box



**CSSBX-4818**  
All models come with unattached Control Box only

### COLD BUILT-IN SIMULATED STONE SHELVES (flush to countertop)

Model	Overall Shelf Dimensions	Shelf Space	Voltage			Comp. Size	Approx. Ship Weight	List Price
	(includes brackets) W x D		W x D	Single Phase	Watts			
<b>CSSB-2418</b>	27" x 21"	24" x 18"	120	300	60	1/5	126 lbs.	<b>\$8359</b>
<b>CSSB-3018</b>	33" x 21"	30" x 18"	120	300	60	1/5	132 lbs.	<b>8446</b>
<b>CSSB-3618</b>	39" x 21"	36" x 18"	120	300	60	1/5	145 lbs.	<b>8713</b>
<b>CSSB-4818</b>	51" x 21"	48" x 18"	120	450	60	1/3	172 lbs.	<b>9887</b>

All Cold Built-In Simulated Stone Shelf Models Feature:

Models Shipped with: Electronic Temperature Control and a condensing unit, 6' cord and plug (NEMA 5-15P).

### COLD BUILT-IN SIMULATED STONE SHELVES with UNATTACHED CONDENSER/CONTROL BOX (flush to countertop)

Model	Overall Shelf Dimensions	Shelf Space	Voltage			Comp. Size	Approx. Ship Weight	List Price
	(includes brackets) W x D		W x D	Single Phase	Watts			
<b>CSSBR-2418</b>	27" x 21"	24" x 18"	120	300	60	1/5	88 lbs.	<b>\$7427</b>
<b>CSSBR-3018</b>	33" x 21"	30" x 18"	120	300	60	1/5	126 lbs.	<b>7514</b>
<b>CSSBR-3618</b>	39" x 21"	36" x 18"	120	300	60	1/5	139 lbs.	<b>7781</b>
<b>CSSBR-4818</b>	51" x 21"	48" x 18"	120	450	60	1/3	164 lbs.	<b>8955</b>

All Cold Built-In Simulated Stone Shelf Models with Unattached Condenser/Control Box Feature:

Models Shipped with: Shelf assembly with temperature probe, Control Box, condensing unit and TXV (all shipped loose).

### COLD BUILT-IN SIMULATED STONE SHELVES with UNATTACHED CONTROL BOX only (flush to countertop)

Model	Overall Shelf Dimensions	Shelf Space	Watts		Approx. Ship Weight	List Price
	(includes brackets) W x D		120V Single Phase	Hz		
<b>CSSBX-2418</b>	27" x 21"	24" x 18"	12	60	75 lbs.	<b>\$6246</b>
<b>CSSBX-3018</b>	33" x 21"	30" x 18"	12	60	87 lbs.	<b>6333</b>
<b>CSSBX-3618</b>	39" x 21"	36" x 18"	12	60	99 lbs.	<b>6600</b>
<b>CSSBX-4818</b>	51" x 21"	48" x 18"	12	60	125 lbs.	<b>7774</b>

All Cold Built-In Simulated Stone Shelf Models with Unattached Control Box Only Feature:

Models Shipped with: Shelf assembly with temperature probe, solenoid valve (attached to shelf), Control Box (shipped loose) and TXV (unattached).

### COUNTERTOP CUTOUT DIMENSIONS

Model	Width with 3/8" radii	Height with 3/8" radii
<b>CSSB(R)(X)-2418</b>	24 <sup>3</sup> / <sub>8</sub> "	18 <sup>3</sup> / <sub>8</sub> "
<b>CSSB(R)(X)-3018</b>	30 <sup>3</sup> / <sub>8</sub> "	18 <sup>3</sup> / <sub>8</sub> "
<b>CSSB(R)(X)-3618</b>	36 <sup>3</sup> / <sub>8</sub> "	18 <sup>3</sup> / <sub>8</sub> "
<b>CSSB(R)(X)-4818</b>	48 <sup>3</sup> / <sub>8</sub> "	18 <sup>3</sup> / <sub>8</sub> "

Model	Width	Height
<b>Control Box</b>	9 <sup>1</sup> / <sub>2</sub> "	7 <sup>3</sup> / <sub>4</sub> "

### OPTIONS

(available at time of purchase only)

Simulated stone colors – Non-standard colors are non-returnable – Night Sky standard –

**SS-GGRAN** Gray Granite **No Charge**

**SS-BSAND** Bermuda Sand **No Charge**

**COND-8.5** 102" cord (60" standard), CSSB models only **\$ 15**

**EWC** (Additional four year extended Parts Only Warranty on the compressor available at the time of unit purchase CSSB, CSSBR models only) **200**

### COLORS AND FINISHES – INSIDE BACK COVER

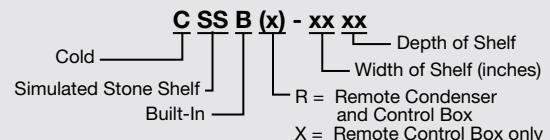



## Cold Built-In Flush Top Simulated Stone Shelves

Hatco's, sturdy Cold Built-In Flush Top Simulated Stone Shelves are a must for buffet lines in cafeterias, restaurants and more!

- Patented thermal break reduces condensation and temperature transfer on adjacent surfaces
- All models are bottom mount units
- Control Box comes standard with a 4' lead wire
- Control Box can be mounted 4' from center of the shelf (CSSBF models only)
- CSSBF models offer a long, flexible, refrigerant line which allows condensing unit to be pulled out for service
- Condensing unit features easy serviceability with sight glass, service valves, dryer/filter and receiver (CSSBF, CSSBFR models only)
- Simulated stone is Swanstone®

*continued on next page...*



**CSSBF-48-S**  
in standard Night Sky simulated stone



**CSSBFR-48-S**  
in optional Bermuda Sand – All models come with unattached Condenser and Control Box

### COLD BUILT-IN FLUSH TOP SIMULATED STONE SHELVES

Model	Overall Shelf Dimensions (includes brackets) W x D	Shelf Space W x D	Voltage			Comp. Size HP	Approx. Ship Weight	List Price
			Single Phase	Watts	Hz			
CSSBF-24-F	27" x 18½"	24" x 15½"	120	300	60	1/5	119 lbs.	\$ 8345
CSSBF-24-I	27" x 22½"	24" x 19½"	120	300	60	1/5	124 lbs.	8380
CSSBF-24-S	27" x 27"	24" x 24"	120	300	60	1/5	134 lbs.	8650
CSSBF-36-F	39" x 18½"	36" x 15½"	120	300	60	1/5	138 lbs.	8674
CSSBF-36-I	39" x 22½"	36" x 19½"	120	450	60	1/3	155 lbs.	8710
CSSBF-36-S	39" x 27"	36" x 24"	120	450	60	1/3	164 lbs.	10253
CSSBF-48-F	51" x 18½"	48" x 15½"	120	450	60	1/3	159 lbs.	9849
CSSBF-48-I	51" x 22½"	48" x 19½"	120	450	60	1/3	171 lbs.	9886
CSSBF-48-S	51" x 27"	48" x 24"	120	800	60	5/8	189 lbs.	11596

**All Cold Built-In Flush Top Simulated Stone Shelf Models Feature:**

Electronic Temperature Control and a condensing unit, 6' cord and plug (NEMA 5-15P).

### COLD BUILT-IN FLUSH TOP SIMULATED STONE SHELVES with UNATTACHED CONDENSER/CONTROL BOX

Model	Overall Shelf Dimensions (includes brackets) W x D	Shelf Space W x D	Voltage			Comp. Size HP	Approx. Ship Weight	List Price
			Single Phase	Watts	Hz			
CSSBFR-24-F	27" x 18½"	24" x 15½"	120	300	60	1/5	120 lbs.	\$ 7413
CSSBFR-24-I	27" x 22½"	24" x 19½"	120	300	60	1/5	123 lbs.	7448
CSSBFR-24-S	27" x 27"	24" x 24"	120	300	60	1/5	150 lbs.	7718
CSSBFR-36-F	39" x 18½"	36" x 15½"	120	300	60	1/5	151 lbs.	7742
CSSBFR-36-I	39" x 22½"	36" x 19½"	120	450	60	1/3	151 lbs.	7778
CSSBFR-36-S	39" x 27"	36" x 24"	120	450	60	1/3	161 lbs.	9321
CSSBFR-48-F	51" x 18½"	48" x 15½"	120	450	60	1/3	158 lbs.	8917
CSSBFR-48-I	51" x 22½"	48" x 19½"	120	450	60	1/3	178 lbs.	8954
CSSBFR-48-S	51" x 27"	48" x 24"	120	800	60	5/8	166 lbs.	10664

**All Cold Built-In Flush Top Simulated Stone Shelf Models with Unattached Condenser/Control Box Feature:**

Models Shipped with: Shelf assembly with temperature probe, Control Box, condensing unit and TXV (all shipped loose).

**OPTIONS – PAGE 138**



July 1, 2024

## Cold Built-In Flush Top Simulated Stone Shelves

continued...

- CSSBR models have unattached Condensing unit and Control Box, CSSBX models have unattached Control Box only
- CSSBFR, CSSBFX models have benefit of allowing fabricators the freedom to design



**CSSBFX-48-S**  
in optional Gray Granite simulated stone – All models come with unattached Control Box only

### COLD BUILT-IN FLUSH TOP SIMULATED STONE SHELVES with UNATTACHED CONTROL BOX only

Model	Overall Shelf Dimensions (includes brackets) W x D	Shelf Space W x D	Watts 120V Single Phase	Hz	Approx. Ship Weight	List Price
CSSBFX-24-F	27" x 18½"	24" x 15½"	12	60	78 lbs.	\$6232
CSSBFX-24-I	27" x 22½"	24" x 19½"	12	60	79 lbs.	6267
CSSBFX-24-S	27" x 27"	24" x 24"	12	60	89 lbs.	6537
CSSBFX-36-F	39" x 18½"	36" x 15½"	12	60	97 lbs.	6561
CSSBFX-36-I	39" x 22½"	36" x 19½"	12	60	115 lbs.	6597
CSSBFX-36-S	39" x 27"	36" x 24"	12	60	117 lbs.	8140
CSSBFX-48-F	51" x 18½"	48" x 15½"	12	60	116 lbs.	7736
CSSBFX-48-I	51" x 22½"	48" x 19½"	12	60	130 lbs.	7773
CSSBFX-48-S	51" x 27"	48" x 24"	12	60	144 lbs.	9483

**All Cold Built-In Flush Top Simulated Stone Shelf Models with Unattached Control Box Only Feature:**  
Models Shipped with: Shelf assembly with temperature probe, solenoid valve (attached to shelf), Control Box (shipped loose) and TXV (unattached).

#### OPTIONS (available at time of purchase only)

**Simulated stone colors – Non-standard colors are non-returnable – Night Sky standard –**

<b>SS-GGRAN</b>	Gray Granite	No Charge
<b>SS-BSAND</b>	Bermuda Sand	No Charge
<b>COND-8.5</b>	102" cord (60" standard), CSSBF models only	\$ 15
<b>EWC</b>	Additional four year extended Parts Only Warranty on the compressor available at the time of unit purchase (CSSBF, CSSBFR models only)	200

#### COLORS AND FINISHES – INSIDE BACK COVER

#### COUNTERTOP CUTOUT DIMENSIONS

Model	Width with 3/8" radii	Height with 3/8" radii
CSSBF(R)(X)-24-F	24 3/8"	15 7/8"
CSSBF(R)(X)-24-I	24 3/8"	19 7/8"
CSSBF(R)(X)-24-S	24 3/8"	24 3/4"
CSSBF(R)(X)-36-F	36 3/8"	15 7/8"
CSSBF(R)(X)-36-I	36 3/8"	19 7/8"
CSSBF(R)(X)-36-S	36 3/8"	24 3/4"
CSSBF(R)(X)-48-F	48 3/8"	15 7/8"
CSSBF(R)(X)-48-I	48 3/8"	19 7/8"
CSSBF(R)(X)-48-S	48 3/8"	24 3/4"
Model	Width	Height
Control Box	9 1/2"	7 3/4"

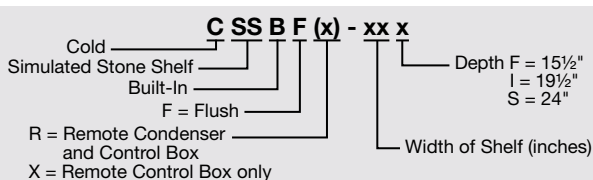

## Cold Built-In Flush Top Shelves

Hatco's Cold Built-In Flush Top Shelves, in our signature Hardcoat Aluminum, are designed to keep your pre-chilled beverages, hors d'oeuvres, side dishes, buffet items and more, perfectly chilled.

- Patented thermal break reduces condensation and temperature transfer on adjacent surfaces
- All models are top mounted with an Hardcoat Aluminum surface
- All models match the GRSBF Heated Built-In Shelves for a fully integrated look
- Control Box comes standard with a 4' lead wire
- Control Box can be mounted 4' from center of the shelf (CSBF models only)
- CSBF models offer a long, flexible, refrigerant line which allows condensing unit to be pulled out for service
- Condensing unit features easy serviceability with sight glass, service valves, dryer/filter and receiver (CSBF, CSBFR models only)

*continued on next page...*



**CSBF-48-S**  
(Flush Top)



**CSBFR-48-S**  
(Flush Top) All models come with unattached Condenser and Control Box



### COLD BUILT-IN FLUSH TOP SHELVES (Hardcoat Aluminum)

Model	Overall Shelf Dimensions W x D	Usable Shelf Space W x D	Voltage Single Phase	Watts	Comp. Size HP	Hz	Approx. Ship Weight	List Price
<b>CSBF-24-F</b>	25½" x 17"	24" x 15½"	120	300	1/5	60	108 lbs.	<b>\$ 8031</b>
<b>CSBF-24-I</b>	25½" x 21"	24" x 19½"	120	300	1/5	60	116 lbs.	<b>8059</b>
<b>CSBF-24-S</b>	25½" x 25½"	24" x 24"	120	300	1/5	60	117 lbs.	<b>8172</b>
<b>CSBF-36-F</b>	37½" x 17"	36" x 15½"	120	300	1/5	60	130 lbs.	<b>8197</b>
<b>CSBF-36-I</b>	37½" x 21"	36" x 19½"	120	450	1/3	60	130 lbs.	<b>8232</b>
<b>CSBF-36-S</b>	37½" x 25½"	36" x 24"	120	450	1/3	60	151 lbs.	<b>9415</b>
<b>CSBF-48-F</b>	49½" x 17"	48" x 15½"	120	450	1/3	60	138 lbs.	<b>9216</b>
<b>CSBF-48-I</b>	49½" x 21"	48" x 19½"	120	450	1/3	60	157 lbs.	<b>9253</b>
<b>CSBF-48-S</b>	49½" x 25½"	48" x 24"	120	800	5/8	60	177 lbs.	<b>10248</b>

**All Cold Built-In Flush Top Shelf Models Feature:**

Electronic Temperature Control and a condensing unit, 6' cord and plug (NEMA 5-15P).

### COLD BUILT-IN FLUSH TOP SHELVES (Hardcoat Aluminum) with UNATTACHED CONDENSER/CONTROL BOX

Model	Overall Shelf Dimensions W x D	Usable Shelf Space W x D	Voltage Single Phase	Watts	Comp. Size HP	Hz	Approx. Ship Weight	List Price
<b>CSBFR-24-F</b>	25½" x 17"	24" x 15½"	120	300	1/5	60	102 lbs.	<b>\$7285</b>
<b>CSBFR-24-I</b>	25½" x 21"	24" x 19½"	120	300	1/5	60	116 lbs.	<b>7313</b>
<b>CSBFR-24-S</b>	25½" x 25½"	24" x 24"	120	300	1/5	60	126 lbs.	<b>7426</b>
<b>CSBFR-36-F</b>	37½" x 17"	36" x 15½"	120	300	1/5	60	127 lbs.	<b>7451</b>
<b>CSBFR-36-I</b>	37½" x 21"	36" x 19½"	120	450	1/3	60	128 lbs.	<b>7486</b>
<b>CSBFR-36-S</b>	37½" x 25½"	36" x 24"	120	450	1/3	60	139 lbs.	<b>8669</b>
<b>CSBFR-48-F</b>	49½" x 17"	48" x 15½"	120	450	1/3	60	145 lbs.	<b>8470</b>
<b>CSBFR-48-I</b>	49½" x 21"	48" x 19½"	120	450	1/3	60	147 lbs.	<b>8507</b>
<b>CSBFR-48-S</b>	49½" x 25½"	48" x 24"	120	800	5/8	60	166 lbs.	<b>9502</b>

**All Cold Built-In Flush Top Shelf With Unattached Condenser/Control Box Models Feature:**

Models Shipped with: Shelf assembly with temperature probe, Control Box, condensing unit and TXV (all shipped loose).

**OPTIONS – PAGE 140**



July 1, 2024

## Cold Built-In Flush Top Shelves

*continued...*

- CSBFR models have unattached Condensing unit and Control Box, CSBFX models have unattached Control Box only
- CSBFR, CSBFX models have benefit of allowing fabricators the freedom to design



**CSBFX-48-S**  
(Flush Top) All models come with unattached Control Box only

### COLD BUILT-IN FLUSH TOP SHELVES (Hardcoat Aluminum) with UNATTACHED CONTROL BOX only

Model	Overall Shelf Dimensions W x D	Usable Shelf Space W x D	Watts 120V Single Phase	Approx. Ship Weight	List Price
CSBFX-24-F	25½" x 17"	24" x 15½"	12	63 lbs.	\$5918
CSBFX-24-I	25½" x 21"	24" x 19½"	12	71 lbs.	5946
CSBFX-24-S	25½" x 25½"	24" x 24"	12	79 lbs.	6059
CSBFX-36-F	37½" x 17"	36" x 15½"	12	68 lbs.	6084
CSBFX-36-I	37½" x 21"	36" x 19½"	12	90 lbs.	6119
CSBFX-36-S	37½" x 25½"	36" x 24"	12	100 lbs.	7302
CSBFX-48-F	49½" x 17"	48" x 15½"	12	117 lbs.	7103
CSBFX-48-I	49½" x 21"	48" x 19½"	12	117 lbs.	7140
CSBFX-48-S	49½" x 25½"	48" x 24"	12	130 lbs.	8135

**All Cold Built-In Flush Top Shelf Models with Unattached Control Box Only Feature:**  
Shelf assembly with temperature probe, solenoid valve (attached to shelf), Control Box (shipped loose) and TXV (unattached).

### COUNTERTOP CUTOUT DIMENSIONS

Model	Width		Height	
	Min	Max	Min	Max
CSBF(R)(X)-24-F	24¾"	25"	16⅛"	16½"
CSBF(R)(X)-24-I	24¾"	25"	20⅛"	20½"
CSBF(R)(X)-24-S	24¾"	25"	24¾"	25"
CSBF(R)(X)-36-F	36¾"	37"	16⅛"	16½"
CSBF(R)(X)-36-I	36¾"	37"	20⅛"	20½"
CSBF(R)(X)-36-S	36¾"	37"	24¾"	25"
CSBF(R)(X)-48-F	48¾"	49"	16⅛"	16½"
CSBF(R)(X)-48-I	48¾"	49"	20⅛"	20½"
CSBF(R)(X)-48-S	48¾"	49"	24¾"	25"
Model	Width		Height	
Control Box	9½"		7¾"	

### OPTIONS (available at time of purchase only)

<b>COND-8.5</b>	102" cord (60" standard), CSBF models only	\$ 15
<b>EWC</b>	Additional four year extended Parts Only Warranty on the compressor available at the time of unit purchase (CSBF, CSBFR models only)	200

### COLORS AND FINISHES – INSIDE BACK COVER

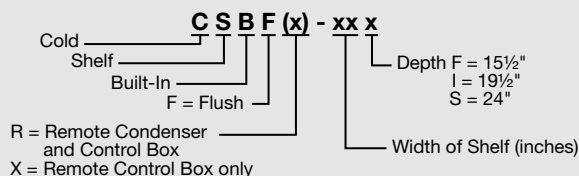



## Cold Undermount Shelves

Cold Undermount Shelves provide a cold surface like the Cold Built-in Flush Top Shelves, but are mounted directly against the underside of a granite, quartz, Stainless Steel or appropriate solid surface counter top. Cooling transfers through the countertop with a seamless look.

- Mounts directly to underside of appropriate countertop material
- Approved materials include granite and quartz up to 1 3/16", Swanstone® (provided by Hatco), and certain Stainless Steel or aluminum surfaces approved by Hatco. Please contact the factory for applications with other materials \*
- All models feature an anodized aluminum surface
- Control Box comes standard with a 4' lead wire
- Control Box can be mounted 4' from center of the shelf (CSU models only)
- CSU models offer a long, flexible, refrigerant line which allows condensing unit to be pulled out for service
- Condensing unit features easy serviceability with sight glass, service valves, dryer/filter and receiver (CSU, CSUR models only)

*continued on next page...*



**CSU-48-S**  
(Undermount)



**CSUR-48-S**  
(Undermount)  
All models include unattached Condenser and Control Box only



### COLD UNDERMOUNT SHELVES (Anodized Aluminum)

Model #	Overall Shelf Dimensions (includes brackets) W x D	Usable Shelf Space W x D	Watts 120V Single Phase	Hz	Compressor Size HP	Approx. Ship Weight	List Price
CSU-24-F	27 5/16" x 18 13/16"	24" x 15 1/2"	300	60	1/5	115 lbs.	<b>\$7555</b>
CSU-24-I	27 5/16" x 22 13/16"	24" x 19 1/2"	300	60	1/5	118 lbs.	<b>7589</b>
CSU-24-S	27 5/16" x 27 13/16"	24" x 24"	300	60	1/5	130 lbs.	<b>7665</b>
CSU-36-F	39 5/16" x 18 13/16"	36" x 15 1/2"	300	60	1/5	140 lbs.	<b>7543</b>
CSU-36-I	39 5/16" x 22 13/16"	36" x 19 1/2"	450	60	1/3	143 lbs.	<b>7556</b>
CSU-36-S	39 5/16" x 27 13/16"	36" x 24"	450	60	1/3	125 lbs.	<b>8594</b>
CSU-48-F	51 5/16" x 18 13/16"	48" x 15 1/2"	450	60	1/3	141 lbs.	<b>8380</b>
CSU-48-I	51 5/16" x 22 13/16"	48" x 19 1/2"	450	60	1/3	144 lbs.	<b>8415</b>
CSU-48-S	51 5/16" x 27 13/16"	48" x 24"	800	60	5/8	178 lbs.	<b>9162</b>

**All Cold Undermount Shelf Models Feature:**

**Models Shipped with:** Electronic Temperature Control and a condensing unit, 6' cord and plug (NEMA 5-15P), thermal mastic caulk and single use applicator.

### COLD UNDERMOUNT SHELVES with UNATTACHED CONDENSER/CONTROL BOX (Anodized Aluminum)

Model #	Overall Shelf Dimensions (includes brackets) W x D	Shelf Space W x D	Watts 120V Single Phase	Hz	Compressor Size HP	Approx. Ship Weight	List Price
CSUR-24-F	27 5/16" x 18 13/16"	24" x 15 1/2"	300	60	1/5	110 lbs.	<b>\$6623</b>
CSUR-24-I	27 5/16" x 22 13/16"	24" x 19 1/2"	300	60	1/5	110 lbs.	<b>6657</b>
CSUR-24-S	27 5/16" x 27 13/16"	24" x 24"	300	60	1/5	119 lbs.	<b>6733</b>
CSUR-36-F	39 5/16" x 18 13/16"	36" x 15 1/2"	300	60	1/5	111 lbs.	<b>6611</b>
CSUR-36-I	39 5/16" x 22 13/16"	36" x 19 1/2"	450	60	1/3	118 lbs.	<b>6624</b>
CSUR-36-S	39 5/16" x 27 13/16"	36" x 24"	450	60	1/3	143 lbs.	<b>7662</b>
CSUR-48-F	51 5/16" x 18 13/16"	48" x 15 1/2"	450	60	1/3	150 lbs.	<b>7448</b>
CSUR-48-I	51 5/16" x 22 13/16"	48" x 19 1/2"	450	60	1/3	150 lbs.	<b>7483</b>
CSUR-48-S	51 5/16" x 27 13/16"	48" x 24"	800	60	5/8	150 lbs.	<b>8230</b>



CSU and CSUR models include thermal mastic caulk and a single use applicator

**All Cold Undermount Shelf Models with Unattached Condenser/Control Box Feature:**

**Models Shipped with:** Shelf assembly with temperature probe, Control Box, condensing unit and TXV (all shipped loose), thermal mastic caulk and single use applicator.

Make structural modifications or add bracing underneath the countertop to ensure countertop will support the weight of the unit and its contents. For mounting bolt and substrate cutout dimensions, please refer to the Installation section in the Operating Manual which is found on the Hatco website, [www.hatcocorp.com](http://www.hatcocorp.com).

**OPTIONS – PAGE 142**



July 1, 2024

## Cold Undermount Shelves

continued...

- CSUR models have unattached Condensing unit and Control Box, CSUX models have unattached Control Box only
- CSUR and CSUX models have benefit of allowing fabricators the freedom to design.



**CSUX-48-S**  
(Undermount) All models include unattached Control Box only

### COLD UNDERMOUNT SHELVES (Anodized Aluminum) with UNATTACHED CONTROL BOX only

Model #	Overall Shelf Dimensions (includes brackets) W x D	Shelf Space W x D	Watts 120V Single Phase	Approx. Ship Weight	List Price
CSUX-24-F	27 <sup>5</sup> / <sub>16</sub> " x 18 <sup>13</sup> / <sub>16</sub> "	24" x 15 <sup>1</sup> / <sub>2</sub> "	12	73 lbs.	\$5442
CSUX-24-I	27 <sup>5</sup> / <sub>16</sub> " x 22 <sup>13</sup> / <sub>16</sub> "	24" x 19 <sup>1</sup> / <sub>2</sub> "	12	75 lbs.	5476
CSUX-24-S	27 <sup>5</sup> / <sub>16</sub> " x 27 <sup>13</sup> / <sub>16</sub> "	24" x 24"	12	84 lbs.	5552
CSUX-36-F	39 <sup>5</sup> / <sub>16</sub> " x 18 <sup>13</sup> / <sub>16</sub> "	36" x 15 <sup>1</sup> / <sub>2</sub> "	12	91 lbs.	5430
CSUX-36-I	39 <sup>5</sup> / <sub>16</sub> " x 22 <sup>13</sup> / <sub>16</sub> "	36" x 19 <sup>1</sup> / <sub>2</sub> "	12	95 lbs.	5443
CSUX-36-S	39 <sup>5</sup> / <sub>16</sub> " x 27 <sup>13</sup> / <sub>16</sub> "	36" x 24"	12	99 lbs.	6481
CSUX-48-F	51 <sup>5</sup> / <sub>16</sub> " x 18 <sup>13</sup> / <sub>16</sub> "	48" x 15 <sup>1</sup> / <sub>2</sub> "	12	102 lbs.	6267
CSUX-48-I	51 <sup>5</sup> / <sub>16</sub> " x 22 <sup>13</sup> / <sub>16</sub> "	48" x 19 <sup>1</sup> / <sub>2</sub> "	12	113 lbs.	6302
CSUX-48-S	51 <sup>5</sup> / <sub>16</sub> " x 27 <sup>13</sup> / <sub>16</sub> "	48" x 24"	12	124 lbs.	7049

**All Cold Undermount Shelf Models with Unattached Control Box only Feature:**

Models Shipped with: Shelf assembly with temperature probe, solenoid valve (attached to shelf), Control Box (shipped loose) and TXV (unattached).

- Make structural modifications or add bracing underneath the countertop to ensure countertop will support the weight of the unit and its contents. For mounting bolt and substrate cutout dimensions, please refer to the Installation section in the Operating Manual which is found on the Hatco website, [www.hatcocorp.com](http://www.hatcocorp.com).

### OPTIONS (available at time of purchase only)

COND-8.5	102" conduit (60" standard), CSU models only	\$ 15
EWC	Additional four year extended Parts Only Warranty on the compressor available at the time of unit purchase (CSU, CSUR models only)	200

### CUTOUT DIMENSIONS

Model	Width	Height
Control Box	9 <sup>1</sup> / <sub>2</sub> "	7 <sup>3</sup> / <sub>4</sub> "

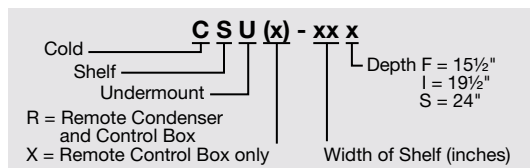

## Hot/Cold Built-In Simulated Stone Shelves

Give your operation ultimate flexibility with Hatco's innovative, patented, Hot/Cold Built-In Simulated Stone Shelves. They easily transition between a heated to cold and cold to heated shelf!

- Patented thermal break reduces condensation and temperature transfer on adjacent surfaces
- Shelves change modes from hot to cold or vice versa in as little as 30 minutes, allowing quick change for different dayparts
- All models are bottom mount, flush with the countertop
- Simulated stone is Swanstone® and Dekton®
- All models match the GRSSB Heated Built-In Shelves
- Control Box with a 4' lead wire is standard
- Control Box can be mounted 4' from center of the shelf (HCSSB models only)
- HCSSB models offer a long, flexible, refrigerant line which allows condensing unit to be pulled out for service
- Condensing unit features easy serviceability with sight glass, service valves, dryer/filter and receiver (HCSSB, HCSSBR models only)
- HCSSBR has unattached Condensing unit and Control Box, HCSSBX has unattached Control Box only

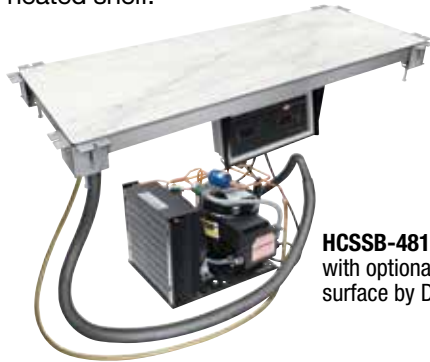

**HCSSB-4818** with optional Rem surface by Dekton®

### COUNTERTOP CUTOUT DIMENSIONS

Model	Width with 3/8" radii	Height with 3/8" radii
HCSSB(R)(X)-2418	24 3/8"	18 3/8"
HCSSB(R)(X)-3018	30 3/8"	18 3/8"
HCSSB(R)(X)-3618	36 3/8"	18 3/8"
HCSSB(R)(X)-4818	48 3/8"	18 3/8"

Model	Width	Height
Control Box	14 5/8"	7 3/4"

**NEW** Dekton® stone surfaces that are available for these models:

Domoos      Rem      Soke

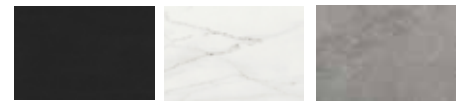

Note: Due to the natural texture, patterns may vary.

### HOT/COLD BUILT-IN SIMULATED STONE SHELVES (flush to countertop)

Model	Overall Shelf Dimensions (includes brackets) W x D	Shelf Space W x D	Volts Single Phase	Cold Side Watts	Hot Side Watts	Hz	Comp. Size HP	Approx. Ship Weight	List Price
HCSSB-2418	27" x 21"	24" x 18"	120	300	405	60	1/5	133 lbs.	\$ 9731
HCSSB-3018	33" x 21"	30" x 18"	120	300	510	60	1/5	150 lbs.	9830
HCSSB-3618	39" x 21"	36" x 18"	120	300	610	60	1/5	160 lbs.	10009
HCSSB-4818	51" x 21"	48" x 18"	120	450	815	60	1/3	187 lbs.	11035

All Hot/Cold Built-In Simulated Stone Shelf Models Feature: Electronic Temperature Control and a condensing unit, 6' cord and plug (NEMA 5-15P).

### HOT/COLD BUILT-IN SIMULATED STONE SHELVES (flush to countertop) with UNATTACHED CONDENSER/CONTROL BOX

Model	Overall Shelf Dimensions (includes brackets) W x D	Shelf Space W x D	Volts Single Phase	Cold Side Watts	Hot Side Watts	Hz	Comp. Size HP	Approx. Ship Weight	List Price
HCSSBR-2418	27" x 21"	24" x 18"	120	300	405	60	1/5	115 lbs.	\$ 8799
HCSSBR-3018	33" x 21"	30" x 18"	120	300	510	60	1/5	151 lbs.	8898
HCSSBR-3618	39" x 21"	36" x 18"	120	300	610	60	1/5	162 lbs.	9077
HCSSBR-4818	51" x 21"	48" x 18"	120	450	815	60	1/3	187 lbs.	10103

All Hot/Cold Built-In Simulated Stone Shelf Models with Unattached Condenser/Control Box Feature: Models Shipped with: Shelf assembly with temperature probe, Control Box, condensing unit and TXV (all shipped loose).

### HOT/COLD BUILT-IN SIMULATED STONE SHELVES (flush to countertop) with UNATTACHED CONTROL BOX only

Model	Overall Shelf Dimensions (includes brackets) W x D	Shelf Space W x D	Watts 120V Single Phase	Approx. Ship Weight	List Price
HCSSBX-2418	27" x 21"	24" x 18"	405	75 lbs.	\$7618
HCSSBX-3018	33" x 21"	30" x 18"	510	105 lbs.	7717
HCSSBX-3618	39" x 21"	36" x 18"	610	117 lbs.	7896
HCSSBX-4818	51" x 21"	48" x 18"	815	140 lbs.	8922

All Hot/Cold Built-In Simulated Stone Shelf Models with unattached Control Box Only Feature: Models Shipped with: Shelf assembly with temperature probe, solenoid valve (attached to shelf), Control Box (shipped loose) and TXV (unattached).

**NOTE:** Install Remote Box outside Heat Zone or damage will occur.

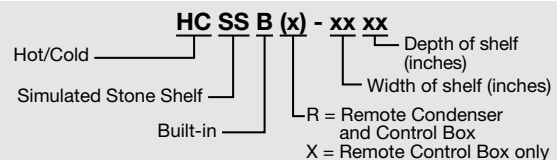

### OPTIONS

(available at time of purchase only)

Simulated stone colors – Non-standard colors are non-returnable – Night Sky standard –

SS-GGRAN	Gray Granite	No Charge
SS-BSAND	Bermuda Sand	No Charge
COND-8.5CC	102" conduit (72" standard), HCSSB models only	\$ 22
EWC	Additional four year extended Parts Only Warranty on the compressor available at the time of unit purchase (HCSSB, HCSSBR models only)	200

Dekton® Stone Colors –

All Dekton surfaces are non-returnable –

HCSSB-2418 – Hot/Cold Built-In Shelves –		
DOMOOS	Domoos	\$ 677
REM	Rem	677
SOKE	Soke	677
HCSSB-3018 – Hot/Cold Built-In Shelves –		
DOMOOS	Domoos	\$ 940
REM	Rem	940
SOKE	Soke	940
HCSSB-3618 – Hot/Cold Built-In Shelves –		
DOMOOS	Domoos	\$1088
REM	Rem	1088
SOKE	Soke	1088
HCSSB-4818 – Hot/Cold Built-In Shelves –		
DOMOOS	Domoos	\$1151
REM	Rem	1151
SOKE	Soke	1151

**COLORS AND FINISHES – INSIDE BACK COVER**



July 1, 2024

## Hot/Cold Built-In Flush Top Simulated Stone Shelves

Give your operation ultimate flexibility with Hatco's innovative, patented Hot/Cold Built-In Flush Top Simulated Stone Shelves. They easily transition between a heated to cold and cold to heated shelf!

- Patented thermal break reduces condensation and temperature transfer on adjacent surfaces
- Shelves change modes from hot to cold or vice versa in as little as 30 minutes, allowing quick change for different dayparts
- All units are bottom mount, flush with the countertop
- Simulated stone is Swanstone®
- Control Box comes standard with a 4' lead wire
- Control Box can be mounted 4' from center of the shelf (HCSSBF models only)
- HCSSBF models offer a long, flexible, refrigerant line which allows condensing unit to be pulled out for service
- Condensing unit features easy serviceability with sight glass, service valves, dryer/filter and receiver (HCSSBF, HCSSBFR models only)

*continued on next page...*



**HCSSBF-48-S**  
in standard Night Sky simulated stone



**HCSSBFR-48-S**  
in optional Granite Gray simulated stone – All models include unattached Condenser and Control Box only

### HOT/COLD BUILT-IN FLUSH TOP SIMULATED STONE SHELVES

Model	Overall Shelf Dimensions (includes brackets) W x D	Shelf Space W x D	Voltage Single Phase	Cold Side Watts	Hot Side Watts	Hz	Comp. Size HP	Approx. Ship Weight	List Price
HCSSBF-24-F	27" x 18½"	24" X 15½"	120	300	355	60	1/5	139 lbs.	\$ 9669
HCSSBF-24-I	27" x 22½"	24" X 19½"	120	300	445	60	1/5	134 lbs.	9731
HCSSBF-24-S	27" x 27"	24" X 24"	120	300	550	60	1/5	153 lbs.	9821
HCSSBF-36-F	39" x 18½"	36" X 15½"	120	300	530	60	1/5	164 lbs.	9972
HCSSBF-36-I	39" x 22½"	36" X 19½"	120	450	670	60	1/3	164 lbs.	10009
HCSSBF-36-S	39" x 27"	36" X 24"	120	450	825	60	1/3	180 lbs.	11186
HCSSBF-48-F	51" x 18½"	48" X 15½"	120	450	710	60	1/3	183 lbs.	10318
HCSSBF-48-I	51" x 22½"	48" X 19½"	120	450	890	60	1/3	195 lbs.	11097
HCSSBF-48-S	51" x 27"	48" X 24"	120	800	1100	60	5/8	243 lbs.	13365

**All Hot/Cold Built-In Flush Top Simulated Stone Shelf Models Feature:**  
Electronic Temperature Control and a condensing unit, 6' cord and plug (NEMA 5-15P).

### HOT/COLD BUILT-IN FLUSH TOP SIMULATED STONE SHELVES with UNATTACHED CONDENSER/CONTROL BOX

Model	Overall Shelf Dimensions (includes brackets) W x D	Shelf Space W x D	Voltage Single Phase	Cold Side Watts	Hot Side Watts	Hz	Comp. Size HP	Approx. Ship Weight	List Price
HCSSBFR-24-F	27" x 18½"	24" X 15½"	120	300	355	60	1/5	118 lbs.	\$ 8737
HCSSBFR-24-I	27" x 22½"	24" X 19½"	120	300	445	60	1/5	117 lbs.	8799
HCSSBFR-24-S	27" x 27"	24" X 24"	120	300	550	60	1/5	107 lbs.	8889
HCSSBFR-36-F	39" x 18½"	36" X 15½"	120	300	530	60	1/5	159 lbs.	9040
HCSSBFR-36-I	39" x 22½"	36" X 19½"	120	450	670	60	1/3	159 lbs.	9077
HCSSBFR-36-S	39" x 27"	36" X 24"	120	450	825	60	1/3	190 lbs.	10254
HCSSBFR-48-F	51" x 18½"	48" X 15½"	120	450	710	60	1/3	187 lbs.	9386
HCSSBFR-48-I	51" x 22½"	48" X 19½"	120	450	890	60	1/3	206 lbs.	10165
HCSSBFR-48-S	51" x 27"	48" X 24"	120	800	1100	60	5/8	218 lbs.	12433

**All Hot/Cold Built-In Flush Top Simulated Stone Shelf Models with Unattached Condenser/Control Box Feature:**  
Models Shipped with: Shelf assembly with temperature probe, Control Box, condensing unit and TXV (all shipped loose).

**OPTIONS – PAGE 145**

**NOTE:** Install Remote Box outside Heat Zone or damage will occur.



# Hot/Cold Built-In Flush Top Simulated Stone Shelves

continued...

- HCSSBFR has unattached Condensing unit and Control Box, HCSSBFX has unattached Control Box only
- HCSSBFR and HCSSBFX models have benefit of allowing fabricators the freedom to design



**HCSSBFX-48-S**  
in optional Bermuda Sand  
simulated stone – All models  
include unattached Control  
Box only

## HOT/COLD BUILT-IN FLUSH TOP SIMULATED STONE SHELVES with UNATTACHED CONTROL BOX only

Model	Overall Shelf Dimensions (includes brackets) W x D	Shelf Space W x D	Watts 120V Single Phase	Approx. Ship Weight	List Price
HCSSBFX-24-F	27" x 18½"	24" x 15½"	355	92 lbs.	\$ 7556
HCSSBFX-24-I	27" x 22½"	24" x 19½"	445	97 lbs.	7618
HCSSBFX-24-S	27" x 27"	24" x 24"	550	105 lbs.	7708
HCSSBFX-36-F	39" x 18½"	36" x 15½"	530	114 lbs.	7859
HCSSBFX-36-I	39" x 22½"	36" x 19½"	670	122 lbs.	7896
HCSSBFX-36-S	39" x 27"	36" x 24"	825	153 lbs.	9073
HCSSBFX-48-F	51" x 18½"	48" x 15½"	710	130 lbs.	8205
HCSSBFX-48-I	51" x 22½"	48" x 19½"	890	150 lbs.	8984
HCSSBFX-48-S	51" x 27"	48" x 24"	1100	167 lbs.	11252

All Hot/Cold Built-In Flush Top Simulated Stone Shelf Models with Unattached Control Box Only Feature:

Models Shipped with: Shelf assembly with temperature probe, solenoid valve (attached to shelf), Control Box (shipped loose) and TXV (unattached).

### OPTIONS (available at time of purchase only)

Simulated stone colors – Non-standard colors are non-returnable – Night Sky standard –

SS-GGRAN	Gray Granite	No Charge
SS-BSAND	Bermuda Sand	No Charge
COND-8.5CC	102" conduit (72" standard), HCSSBF models only	\$ 22
EWC	Additional four year extended Parts Only Warranty on the compressor available at the time of unit purchase (HCSSBF, HCSSBFR models only)	200

### COLORS AND FINISHES – INSIDE BACK COVER

### COUNTERTOP CUTOUT DIMENSIONS

Model	Width with 3/8" radii	Height with 3/8" radii
HCSSBF(R)(X)-24-F	24 3/8"	15 7/8"
HCSSBF(R)(X)-24-I	24 3/8"	19 7/8"
HCSSBF(R)(X)-24-S	24 3/8"	24 3/8"
HCSSBF(R)(X)-36-F	36 1/4"	15 7/8"
HCSSBF(R)(X)-36-I	36 1/4"	19 7/8"
HCSSBF(R)(X)-36-S	36 1/4"	24 3/8"
HCSSBF(R)(X)-48-F	48 1/4"	15 7/8"
HCSSBF(R)(X)-48-I	48 1/4"	19 7/8"
HCSSBF(R)(X)-48-S	48 1/4"	24 3/8"
Model	Width	Height
Control Box	14 5/8"	7 3/4"

**NOTE:** Install Remote Box outside Heat Zone or damage will occur.

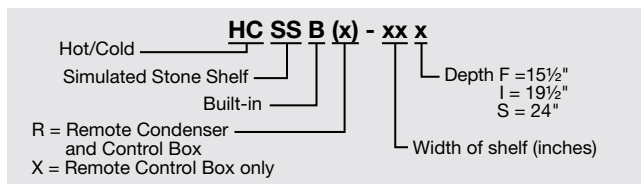



July 1, 2024

## Hot/Cold Built-In Flush Top Shelves

Give your operation ultimate flexibility with Hatco's innovative, patented Hot/Cold Built-In Flush Top Shelves. In our signature Hardcoat Aluminum, they easily transition between a heated to cold and cold to heated shelf!

- Patented thermal break reduces condensation and temperature transfer on adjacent surfaces
  - Shelves change modes from hot to cold or vice versa in as little as 30 minutes, allowing quick change for different dayparts
  - Units are Hardcoat Aluminum, top mount
  - All models match the GRSBF Heated Built-In Shelves for a fully integrated look
  - Control Box with a 4' lead wire is standard
  - Control Box can be mounted 4' from center of the shelf (HCSBF models only)
  - HCSBF models offer a long, flexible, refrigerant line which allows condensing unit to be pulled out for service
  - Condensing unit features easy serviceability with sight glass, service valves, dryer/filter and receiver (HCSBF, HCSBFR models only)
- continued on next page...*



HCSBF-48-S



HCSBFR-48-S All models include unattached Condenser and Control Box only



### HOT/COLD BUILT-IN FLUSH TOP SHELVES (Hardcoat Aluminum)

Model	Overall Shelf Dimensions W x D	Usable Shelf Space W x D	Voltage Single Phase	Cold Side Watts	Hot Side Watts	Hz	Comp. Size HP	Approx. Ship Weight	List Price
HCSBF-24-F	25½" x 17"	24" x 15½"	120	300	355	60	1/5	119 lbs.	\$ 9379
HCSBF-24-I	25½" x 21"	24" x 19½"	120	300	455	60	1/5	126 lbs.	9598
HCSBF-24-S	25½" x 25½"	24" x 24"	120	300	550	60	1/5	140 lbs.	9818
HCSBF-36-F	37½" x 17"	36" x 15½"	120	300	530	60	1/5	126 lbs.	9857
HCSBF-36-I	37½" x 21"	36" x 19½"	120	450	670	60	1/3	137 lbs.	9970
HCSBF-36-S	37½" x 25½"	36" x 24"	120	450	825	60	1/3	148 lbs.	10893
HCSBF-48-F	49½" x 17"	48" x 15½"	120	450	710	60	1/3	161 lbs.	10813
HCSBF-48-I	49½" x 21"	48" x 19½"	120	450	890	60	1/3	172 lbs.	11147
HCSBF-48-S	49½" x 25½"	48" x 24"	120	800	1100	60	5/8	204 lbs.	12172

All Hot/Cold Built-In Flush Top Shelf Models Feature:

Electronic Temperature Control and a condensing unit, 6' cord and plug (NEMA 5-15P).

### HOT/COLD BUILT-IN FLUSH TOP SHELVES (Hardcoat Aluminum) with UNATTACHED CONDENSER/CONTROL BOX

Model	Overall Shelf Dimensions W x D	Usable Shelf Space W x D	Voltage Single Phase	Cold Side Watts	Hot Side Watts	Hz	Comp. Size HP	Approx. Ship Weight	List Price
HCSBFR-24-F	25½" x 17"	24" x 15½"	120	300	355	60	1/5	106 lbs.	\$ 8633
HCSBFR-24-I	25½" x 21"	24" x 19½"	120	300	455	60	1/5	118 lbs.	8852
HCSBFR-24-S	25½" x 25½"	24" x 24"	120	300	550	60	1/5	132 lbs.	9072
HCSBFR-36-F	37½" x 17"	36" x 15½"	120	300	530	60	1/5	147 lbs.	9111
HCSBFR-36-I	37½" x 21"	36" x 19½"	120	450	670	60	1/3	133 lbs.	9224
HCSBFR-36-S	37½" x 25½"	36" x 24"	120	450	825	60	1/3	156 lbs.	10147
HCSBFR-48-F	49½" x 17"	48" x 15½"	120	450	710	60	1/3	145 lbs.	10067
HCSBFR-48-I	49½" x 21"	48" x 19½"	120	450	890	60	1/3	131 lbs.	10401
HCSBFR-48-S	49½" x 25½"	48" x 24"	120	800	1100	60	5/8	255 lbs.	11426

All Hot/Cold Built-In Flush Top Simulated Stone Shelf Models with Unattached Condenser/Control Box Feature:

Models Shipped with: Shelf assembly with temperature probe, Control Box, condensing unit and TXV (all shipped loose).

**OPTIONS – PAGE 147**

**NOTE:** Install Remote Box outside Heat Zone or damage will occur.

## Hot/Cold Built-In Flush Top Shelves

continued...

- HCSBFR models have unattached Condensing unit and Control Box, HCSBFX models have unattached Control Box only
- HCSBFR and HCSBFX models have benefit of allowing fabricators the freedom to design.



**HCSBFX-48-S**  
All models include unattached Control Box only

### HOT/COLD BUILT-IN FLUSH TOP SHELVES (Hardcoat Aluminum) with UNATTACHED CONTROL BOX only

Model	Overall Shelf Dimensions W x D	Usable Shelf Space W x D	Rated Watts 120V Single Phase	Approx. Ship Weight	List Price
HCSBFX-24-F	25½" x 17"	24" x 15½"	355	74 lbs.	\$ 7266
HCSBFX-24-I	25½" x 21"	24" x 19½"	445	84 lbs.	7485
HCSBFX-24-S	25½" x 25½"	24" x 24"	550	95 lbs.	7705
HCSBFX-36-F	37½" x 17"	36" x 15½"	530	105 lbs.	7744
HCSBFX-36-I	37½" x 21"	36" x 19½"	670	114 lbs.	7857
HCSBFX-36-S	37½" x 25½"	36" x 24"	825	116 lbs.	8780
HCSBFX-48-F	49½" x 17"	48" x 15½"	710	120 lbs.	8700
HCSBFX-48-I	49½" x 21"	48" x 19½"	890	131 lbs.	9034
HCSBFX-48-S	49½" x 25½"	48" x 24"	1100	139 lbs.	10059

**All Hot/Cold Built-In Flush Top Simulated Stone Shelf Models with Unattached Control Box Only Feature:**

Models Shipped with: Shelf assembly with temperature probe, solenoid valve (attached to shelf), Control Box (shipped loose) and TXV (unattached).

#### OPTIONS (available at time of purchase only)

<b>COND-8.5CC</b>	102" conduit (72" standard), HCSBF models only	\$ 22
<b>EWC</b>	Additional four year extended Parts Only Warranty on the compressor available at the time of unit purchase (HCSBF, HCSBFR models only)	200

#### COLORS AND FINISHES – INSIDE BACK COVER

#### COUNTERTOP CUTOUT DIMENSIONS

Model	Width		Height	
	Min	Max	Min	Max
HCSBF(R)(X)-24-F	24 <sup>5</sup> / <sub>8</sub> "	25"	16 <sup>1</sup> / <sub>8</sub> "	16½"
HCSBF(R)(X)-24-I	24 <sup>5</sup> / <sub>8</sub> "	25"	20 <sup>1</sup> / <sub>8</sub> "	20½"
HCSBF(R)(X)-24-S	24 <sup>5</sup> / <sub>8</sub> "	25"	24 <sup>3</sup> / <sub>4</sub> "	25"
HCSBF(R)(X)-36-F	36 <sup>5</sup> / <sub>8</sub> "	37"	16 <sup>1</sup> / <sub>8</sub> "	16½"
HCSBF(R)(X)-36-I	36 <sup>5</sup> / <sub>8</sub> "	37"	20 <sup>1</sup> / <sub>8</sub> "	20½"
HCSBF(R)(X)-36-S	36 <sup>5</sup> / <sub>8</sub> "	37"	24 <sup>3</sup> / <sub>4</sub> "	25"
HCSBF(R)(X)-48-F	48 <sup>5</sup> / <sub>8</sub> "	49"	16 <sup>1</sup> / <sub>8</sub> "	16½"
HCSBF(R)(X)-48-I	48 <sup>5</sup> / <sub>8</sub> "	49"	20 <sup>1</sup> / <sub>8</sub> "	20½"
HCSBF(R)(X)-48-S	48 <sup>5</sup> / <sub>8</sub> "	49"	24 <sup>3</sup> / <sub>4</sub> "	25"
Model	Width		Height	
Control Box	14 <sup>5</sup> / <sub>8</sub> "		7 <sup>3</sup> / <sub>4</sub> "	

**NOTE:** Install Remote Box outside Heat Zone or damage will occur.

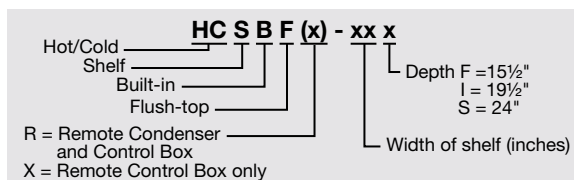



July 1, 2024

## Glo-Ray® Built-In Rectangular Heated Simulated Stone Shelves

Match the heat zone to your countertops with these versatile shelves. These shelves are ideal for buffet lines or as hors d'oeuvre displays. These unique warmers will safely hold food hot while blending in with your décor.

- Shelves are made of approved foodsafe materials
- Features a lighted rocker switch and thermostatically-controlled heated base
- Includes Control Box with 3' conduit and 6' cord and plug
- Simulated stone is Swanstone®



GRSSB-3618 in optional Bermuda Sand built into a Bermuda Sand simulated stone countertop

**NOTE:** For any size GRSSB, the next larger size GRA or GR2A Strip Heater will fit over the top. For example, a GRSSB-3018 will require a GRA-36 or GR2A-36. The GRA will have a tight fit to the frame of the base. The GR2A will have approximately a 4" space.

Standard Control Box



Be sure to check out our Hot/Cold and Cold only Built-In Shelves for a seamless look

### GLO-RAY BUILT-IN RECTANGULAR HEATED SIMULATED STONE SHELVES

Model M	Dimensions W x D x H	Voltage Single Phase	Watts	Plug	Approx. Ship Weight	List Price
GRSSB-2418	25 $\frac{1}{8}$ " x 19 $\frac{1}{8}$ " x 2 $\frac{1}{4}$ "	120	635	NEMA 5-15P	30 lbs.	\$2203
GRSSB-3018	31 $\frac{1}{8}$ " x 19 $\frac{1}{8}$ " x 2 $\frac{1}{4}$ "	120	780	NEMA 5-15P	43 lbs.	2293
GRSSB-3618	37 $\frac{1}{8}$ " x 19 $\frac{1}{8}$ " x 2 $\frac{1}{4}$ "	120	930	NEMA 5-15P	48 lbs.	2390
GRSSB-4818	49 $\frac{1}{8}$ " x 19 $\frac{1}{8}$ " x 2 $\frac{1}{4}$ "	120	1270	NEMA 5-15P	51 lbs.	2709
GRSSB-6018	61 $\frac{1}{8}$ " x 19 $\frac{1}{8}$ " x 2 $\frac{1}{4}$ "	120	1560	NEMA 5-20P	56 lbs.	3555
GRSSB-7218	73 $\frac{1}{8}$ " x 19 $\frac{1}{8}$ " x 2 $\frac{1}{4}$ "	120	1860	NEMA 5-20P	70 lbs.	3703

M Recommended for use in a metallic countertop. For other surfaces, verify that the material is suitable for temperatures up to 200°F. Hatco is not responsible for counter damage caused by heat from the warmer.

All Built-In Rectangular Heated Simulated Stone Shelf Built-In Models Feature:  
Cord Location: Cord is attached to Control Box.

#### OPTIONS (available at time of purchase only)

Designer Color Bezel (Flush Mount Control Box, Bezel only) Stainless Steel standard – Non-standard colors are non-returnable –

RED	Warm Red	BLACK	Black	COPPER	Antique Copper	\$50
GRAY	Gray Granite	WHITE	White Granite			
NAVY	Navy Blue	GREEN	Hunter Green			

Simulated stone color – Non-standard colors are non-returnable – Night Sky standard –

SS-GGRAN	Gray Granite	SS-BSAND	Bermuda Sand	No Charge
SS-NSKY	Night Sky (standard)			

GRSSB-FLUSH-ITC	Flush Mount recessed Electronic Control Box with lighted On/Off rocker switch and angled recessed controls (6 $\frac{13}{32}$ "W x 7 $\frac{13}{16}$ "H x 4 $\frac{13}{16}$ "D)	\$202
-----------------	---	-------

GRSSB-FLUSH-TSTAT	Flush Mount recessed Thermostatic Control Box with lighted On/Off rocker switch and angled recessed controls (6 $\frac{13}{32}$ "W x 7 $\frac{13}{16}$ "H x 4 $\frac{1}{16}$ "D)	No Charge
-------------------	--	-----------

COND-6	6' Conduit (3' standard) – used with Flush Mount ITC Control Boxes only	\$46
--------	---	------

COND-10	10' Conduit (3' standard) – used with Flush Mount ITC Control Boxes only	89
---------	--	----

GRSSB-REC	Built-In Heated Simulated Stone Shelf with 1/2" Recessed Top (Increases total height of model to 2 $\frac{3}{4}$ "	No Charge
-----------	--	-----------



GRSSB-FLUSH-ITC



GRSSB-FLUSH-TSTAT

#### COLORS AND FINISHES – INSIDE BACK COVER

#### GRSSB, GRSB, GRSBF COUNTERTOP CUTOUT DIMENSIONS

Model	Minimum Width	Maximum Width	Minimum Depth	Maximum Depth
GRS(S)B(F)-2418	24 $\frac{3}{8}$ "	24 $\frac{3}{8}$ "	18 $\frac{5}{8}$ "	18 $\frac{7}{8}$ "
GRS(S)B(F)-3018	30 $\frac{3}{8}$ "	30 $\frac{3}{8}$ "	18 $\frac{5}{8}$ "	18 $\frac{7}{8}$ "
GRS(S)B(F)-3618	36 $\frac{3}{8}$ "	36 $\frac{3}{8}$ "	18 $\frac{5}{8}$ "	18 $\frac{7}{8}$ "
GRS(S)B(F)-4818	48 $\frac{3}{8}$ "	48 $\frac{3}{8}$ "	18 $\frac{5}{8}$ "	18 $\frac{7}{8}$ "
GRS(S)B(F)-6018	60 $\frac{3}{8}$ "	60 $\frac{3}{8}$ "	18 $\frac{5}{8}$ "	18 $\frac{7}{8}$ "
GRS(S)B(F)-7218	72 $\frac{3}{8}$ "	72 $\frac{3}{8}$ "	18 $\frac{5}{8}$ "	18 $\frac{7}{8}$ "

#### OPTIONAL GRSSB, GRSB, GRSBF CONTROL BOX CUTOUT DIMENSIONS

Model	Width	Height	Depth
GRS(S)B(F)-FLUSH-ITC	5 $\frac{7}{8}$ "	6 $\frac{3}{8}$ "	4 $\frac{3}{4}$ "
GRS(S)B(F)-FLUSH-TSTAT	5 $\frac{7}{8}$ "	6 $\frac{3}{8}$ "	4"

**NOTE:** Install Remote Box outside Heat Zone or damage will occur.





## Built-In Rectangular Heated Base Glass Shelves

Hatco Built-In Heated Base Glass Shelves have a heated ceramic glass top to create uniform heat across the entire surface and are made of approved foodsafe materials. Adjustable thermostatic controls allow surface temperature to be controlled easily.

- Shelves are made of approved foodsafe materials
- Equipped with an attached Stainless Steel (standard) trim mounting ring (*Designer* Black or White available)

- Includes Control Box with 3' conduit and 6' cord and plug
- Lighted On/Off rocker switch



**HBGB-2418** with optional *Designer* Black Trim Ring



**HBGB-3618** with optional White Glass and Trim Ring

**NOTE:** For any size HBGB, the next larger size GRA or GR2A Strip Heater will fit over the top. For example, a HBGB-3018 will require a GRA-36 or GR2A-36. The GRA will have a tight fit to the frame of the base. The GR2A will have approximately a 4" space.

### BUILT-IN RECTANGULAR HEATED BASE GLASS SHELVES

Model <sup>M</sup>	Dimensions (W x D x H)	Voltage (Single Phase)	Watts	Plug	Approx. Ship Weight	List Price
<b>HBGB-2418</b>	25 <sup>3</sup> / <sub>4</sub> " x 19 <sup>3</sup> / <sub>4</sub> " x 2 <sup>1</sup> / <sub>4</sub> "	120	425	NEMA 5-15P	32 lbs.	<b>\$2986</b>
<b>HBGB-3018</b>	31 <sup>3</sup> / <sub>4</sub> " x 19 <sup>3</sup> / <sub>4</sub> " x 2 <sup>1</sup> / <sub>4</sub> "	120	525	NEMA 5-15P	37 lbs.	<b>3112</b>
<b>HBGB-3618</b>	37 <sup>3</sup> / <sub>4</sub> " x 19 <sup>3</sup> / <sub>4</sub> " x 2 <sup>1</sup> / <sub>4</sub> "	120	630	NEMA 5-15P	40 lbs.	<b>3245</b>
<b>HBGB-4818</b> ≈	49 <sup>3</sup> / <sub>4</sub> " x 19 <sup>3</sup> / <sub>4</sub> " x 2 <sup>1</sup> / <sub>4</sub> "	120	850	NEMA 5-15P	50 lbs.	<b>3556</b>
<b>HBGB-6018</b> ≈	61 <sup>3</sup> / <sub>4</sub> " x 19 <sup>3</sup> / <sub>4</sub> " x 2 <sup>1</sup> / <sub>4</sub> "	120	1050	NEMA 5-15P	63 lbs.	<b>3812</b>
<b>HBGB-7218</b> ≈	73 <sup>3</sup> / <sub>4</sub> " x 19 <sup>3</sup> / <sub>4</sub> " x 2 <sup>1</sup> / <sub>4</sub> "	120	1260	NEMA 5-15P	74 lbs.	<b>4067</b>



Standard Control Box

<sup>M</sup> Recommended for use in a metallic countertop. For other surfaces, verify that the material is suitable for temperatures up to 200°F.

Hatco is not responsible for counter damage caused by heat from the warmer.

≈ Units 48" and larger are constructed of two equal sized pieces of glass which create a seam.

#### All Built-In Rectangular Heated Base Glass Shelf Models Feature:

**Cord Location:** Cord is attached to Control Box.

#### OPTIONS (available at time of purchase only)

<b>Ceramic Glass Color – Black standard – Non-standard colors are non-returnable</b>		<b>No Charge</b>
<b>HBGB-GLASS-WHT</b> White		
<b>Bezel Color (Flush Mount Control Box, Bezel only) – Stainless Steel standard – Non-standard colors are non-returnable –</b>		
<b>HBGB-BEZEL-BLACK</b> Black		<b>\$ 50</b>
<b>HBGB-BEZEL-WHITE</b> White		<b>50</b>
<b>Trim Ring Color – Stainless Steel standard – Non-standard colors are non-returnable –</b>		
<b>HBGB-TRIM-BLK</b> <i>Designer</i> Black		<b>47</b>
<b>HBGB-TRIM-WHITE</b> White		<b>47</b>
<b>HBGB-FLUSH-ITC</b> Flush Mount recessed Electronic Control Box with lighted On/Off rocker switch and angled recessed controls (6 <sup>13</sup> / <sub>32</sub> "W x 7 <sup>13</sup> / <sub>16</sub> "H x 4 <sup>13</sup> / <sub>16</sub> "D)		<b>202</b>
<b>HBGB-FLUSH-TSTAT</b> Flush Mount recessed Thermostatic Control Box with lighted On/Off rocker switch and angled recessed controls (6 <sup>13</sup> / <sub>32</sub> "W x 7 <sup>13</sup> / <sub>16</sub> "H x 4 <sup>1</sup> / <sub>8</sub> "D)		<b>No Charge</b>
<b>COND-6</b> 6' Conduit (3' standard) – used with Flush Mount ITC Control Boxes only		<b>\$46</b>
<b>COND-10</b> 10' Conduit (3' standard) – used with Flush Mount ITC Control Boxes only		<b>89</b>
<b>HBGB-REC</b> Built-In Heated Base Glass Shelf with Recessed Top		<b>No Charge</b>



HBGB-FLUSH-ITC



HBGB-FLUSH-TSTAT

#### HBGB COUNTERTOP CUTOUT DIMENSIONS

Model	Minimum Width	Maximum Width	Minimum Depth	Maximum Depth
<b>HBGB-2418</b>	24 <sup>5</sup> / <sub>8</sub> "	24 <sup>7</sup> / <sub>8</sub> "	18 <sup>5</sup> / <sub>8</sub> "	18 <sup>7</sup> / <sub>8</sub> "
<b>HBGB-3018</b>	30 <sup>5</sup> / <sub>8</sub> "	30 <sup>7</sup> / <sub>8</sub> "	18 <sup>5</sup> / <sub>8</sub> "	18 <sup>7</sup> / <sub>8</sub> "
<b>HBGB-3618</b>	36 <sup>5</sup> / <sub>8</sub> "	36 <sup>7</sup> / <sub>8</sub> "	18 <sup>5</sup> / <sub>8</sub> "	18 <sup>7</sup> / <sub>8</sub> "
<b>HBGB-4818</b>	48 <sup>5</sup> / <sub>8</sub> "	48 <sup>7</sup> / <sub>8</sub> "	18 <sup>5</sup> / <sub>8</sub> "	18 <sup>7</sup> / <sub>8</sub> "
<b>HBGB-6018</b>	60 <sup>5</sup> / <sub>8</sub> "	60 <sup>7</sup> / <sub>8</sub> "	18 <sup>5</sup> / <sub>8</sub> "	18 <sup>7</sup> / <sub>8</sub> "
<b>HBGB-7218</b>	72 <sup>5</sup> / <sub>8</sub> "	72 <sup>7</sup> / <sub>8</sub> "	18 <sup>5</sup> / <sub>8</sub> "	18 <sup>7</sup> / <sub>8</sub> "

#### OPTIONAL CONTROL BOX CUTOUT DIMENSIONS

Model	Width	Height	Depth
<b>HBGB-FLUSH-ITC</b>	5 <sup>7</sup> / <sub>8</sub> "	6 <sup>3</sup> / <sub>8</sub> "	4 <sup>7</sup> / <sub>8</sub> "
<b>HBGB-FLUSH-TSTAT</b>	5 <sup>7</sup> / <sub>8</sub> "	6 <sup>3</sup> / <sub>8</sub> "	4"

**NOTE:** Install Remote Box outside Heat Zone or damage will occur.





July 1, 2024

## Glo-Ray® Built-In Rectangular Recessed Top Aluminum Heated Shelves

Let Hatco add heat to your serving surface with the Glo-Ray Rectangular Heated Shelves Built-In with Recessed Top. This 1/2" recessed top foodwarmer has a Hardcoat Aluminum surface and blanket-type element for uniform heat to extend your food holding time.

- Uniform heat distribution with Hardcoat Aluminum surface and blanket-type element
- Includes Control Box with 3' conduit and 6' cord and plug

- Standard controller includes control thermostat, illuminated power switch and mounting brackets
- Thermostatically-controlled heated base
- For use in countertops up to 1 1/4" thick



GRSB-24-I



Standard Control Box

**NOTE:** For any size GRSB, the next larger size GRA or GR2A Strip Heater will fit over the top. For example, a GRSB-30 will require a GRA-36 or GR2A-36. The GRA will have a tight fit to the frame of the base. The GR2A will have approximately a 4" space.

Be sure to check out our Hot/Cold and Cold only Built-In Shelves for a seamless look

### GLO-RAY BUILT-IN RECTANGULAR RECESSED TOPALUMINUM HEATED SHELVES

Model <sup>M</sup>	Dimensions W x D x H	Cut-Out Dimensions		Voltage Single Phase	Watts	Approx. Ship Weight	List Price
		Min.-Max. Width	Min.-Max. Depth				
GRSB-24-F	25 1/2" x 17" x 2 7/8"	24 1/2"-24 3/4"	16"-16 1/4"	120	420	25 lbs.	<b>\$1841</b>
GRSB-24-I	25 1/2" x 21" x 2 7/8"	24 1/2"-24 3/4"	20"-20 1/4"	120	550	28 lbs.	<b>1848</b>
GRSB-24-O	25 1/2" x 31 1/2" x 2 7/8"	24 1/2"-24 3/4"	30 1/2"-30 3/4"	120	790	33 lbs.	<b>2007</b>
GRSB-30-F	31 1/2" x 17" x 2 7/8"	30 1/2"-30 3/4"	16"-16 1/4"	120	505	25 lbs.	<b>1961</b>
GRSB-30-I	31 1/2" x 21" x 2 7/8"	30 1/2"-30 3/4"	20"-20 1/4"	120	665	29 lbs.	<b>1969</b>
GRSB-30-O	31 1/2" x 31 1/2" x 2 7/8"	30 1/2"-30 3/4"	30 1/2"-30 3/4"	120	950	37 lbs.	<b>2185</b>
GRSB-36-F	37 1/2" x 17" x 2 7/8"	36 1/2"-36 3/4"	16"-16 1/4"	120	590	28 lbs.	<b>2085</b>
GRSB-36-I	37 1/2" x 21" x 2 7/8"	36 1/2"-36 3/4"	20"-20 1/4"	120	780	30 lbs.	<b>2094</b>
GRSB-36-O	37 1/2" x 31 1/2" x 2 7/8"	36 1/2"-36 3/4"	30 1/2"-30 3/4"	120	1110	37 lbs.	<b>2433</b>
GRSB-42-F	43 1/2" x 17" x 2 7/8"	42 1/2"-42 3/4"	16"-16 1/4"	120	685	30 lbs.	<b>2188</b>
GRSB-42-I	43 1/2" x 21" x 2 7/8"	42 1/2"-42 3/4"	20"-20 1/4"	120	885	37 lbs.	<b>2199</b>
GRSB-42-O	43 1/2" x 31 1/2" x 2 7/8"	42 1/2"-42 3/4"	30 1/2"-30 3/4"	120	1270	46 lbs.	<b>2672</b>
GRSB-48-F	49 1/2" x 17" x 2 7/8"	48 1/2"-48 3/4"	16"-16 1/4"	120	770	33 lbs.	<b>2305</b>
GRSB-48-I	49 1/2" x 21" x 2 7/8"	48 1/2"-48 3/4"	20"-20 1/4"	120	1000	40 lbs.	<b>2316</b>
GRSB-48-O	49 1/2" x 31 1/2" x 2 7/8"	48 1/2"-48 3/4"	30 1/2"-30 3/4"	120	1430	68 lbs.	<b>2879</b>
GRSB-54-I	55 1/2" x 21" x 2 7/8"	54 1/2"-54 3/4"	20"-20 1/4"	120	1110	40 lbs.	<b>2431</b>
GRSB-60-F	61 1/2" x 17" x 2 7/8"	60 1/2"-60 3/4"	16"-16 1/4"	120	950	40 lbs.	<b>2543</b>
GRSB-60-I	61 1/2" x 21" x 2 7/8"	60 1/2"-60 3/4"	20"-20 1/4"	120	1220	43 lbs.	<b>2554</b>
GRSB-60-O	61 1/2" x 31 1/2" x 2 7/8"	60 1/2"-60 3/4"	30 1/2"-30 3/4"	120	1750	64 lbs.	<b>3346</b>
GRSB-66-I	67 1/2" x 21" x 2 7/8"	66 1/2"-66 3/4"	20"-20 1/4"	120	1330	49 lbs.	<b>2649</b>
GRSB-72-F	73 1/2" x 17" x 2 7/8"	72 1/2"-72 3/4"	16"-16 1/4"	120	1130	43 lbs.	<b>2748</b>
GRSB-72-I	73 1/2" x 21" x 2 7/8"	72 1/2"-72 3/4"	20"-20 1/4"	120	1440	50 lbs.	<b>2760</b>
GRSB-72-O	73 1/2" x 31 1/2" x 2 7/8"	72 1/2"-72 3/4"	30 1/2"-30 3/4"	208, 240	2070	68 lbs.	<b>3817</b>

<sup>M</sup> Recommended for use in a metallic countertop. For other surfaces, verify that the material is suitable for temperatures up to 200°F. Hatco is not responsible for counter damage caused by heat from the warmer.

**All Glo-Ray Built-In Rectangular Recessed Top Aluminum Heated Shelf Models Feature:**

Plugs: All models ending in -F and -I and models 24" through 48" wide ending in -O: NEMA 5-15P.

GRSB-60-O: NEMA 5-20P.

GRSB-72-O: NEMA 6-15P.

Usable Heated Shelf Space: Subtract 1 1/2" from both width and depth of unit.

Cord Location: Cord is attached to Control Box.

**OPTIONS AND ACCESSORIES – PAGE 151**

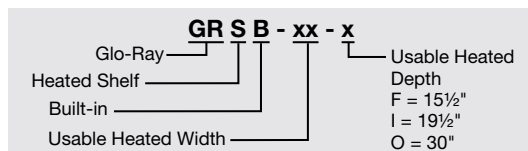

**NOTE:** Install Remote Box outside Heat Zone or damage will occur.



A **GRSB-54-I** Heated Shelf below a **GRAL-96D** Strip Heater

**OPTIONS** (available at time of purchase only)

<b>Designer Color Bezel (Flush Mount Control Box, Bezel only) – Stainless Steel standard</b>		<b>\$ 47</b>
<i>Non-standard colors are non-returnable –</i>		
<b>RED</b>	Warm Red	
<b>WHITE</b>	White Granite	
<b>COPPER</b>	Antique Copper	
<b>BLACK</b>	Black	
<b>NAVY</b>	Navy Blue	
<b>GRAY</b>	Gray Granite	
<b>GREEN</b>	Hunter Green	
<b>GRSB-FLUSH-ITC</b>	Flush Mount recessed Electronic Control Box with lighted On/Off rocker switch and angled recessed controls (6 <sup>13</sup> / <sub>32</sub> "W x 7 <sup>13</sup> / <sub>16</sub> "H x 4 <sup>13</sup> / <sub>16</sub> "D)	<b>200</b>
<b>GRSB-FLUSH-TSTAT</b>	Flush Mount recessed Thermostatic Control Box with lighted On/Off rocker switch and angled recessed controls (6 <sup>13</sup> / <sub>32</sub> "W x 7 <sup>13</sup> / <sub>16</sub> "H x 4 <sup>1</sup> / <sub>8</sub> "D) ▼	<b>No Charge</b>
<b>COND-6</b>	6' Conduit (3' standard) – used with Flush Mount ITC Control Boxes only	<b>\$46</b>
<b>COND-10</b>	10' Conduit (3' standard) – used with Flush Mount ITC Control Boxes only	<b>89</b>

**ACCESSORIES** (available for purchase at any time)

**Stainless Steel Channel Dividers for GRSB models – Required to keep Rods in place – includes front and back Dividers –**

<b>GRSB-CD-24</b>	For GRSB-24 models	<b>\$ 60</b>
<b>GRSB-CD-30</b>	For GRSB-30 models	<b>79</b>
<b>GRSB-CD-36</b>	For GRSB-36 models	<b>100</b>
<b>GRSB-CD-42</b>	For GRSB-42 models	<b>117</b>
<b>GRSB-CD-48</b>	For GRSB-48 models	<b>139</b>
<b>GRSB-CD-54</b>	For GRSB-54 models	<b>159</b>
<b>GRSB-CD-60</b>	For GRSB-60 models	<b>178</b>
<b>GRSB-CD-66</b>	For GRSB-66 models	<b>199</b>
<b>GRSB-CD-72</b>	For GRSB-72 models	<b>219</b>

**Stainless Steel Rods – sold individually –**

<b>GRSB-DIV-F</b>	For F depth units	<b>each \$27</b>
<b>GRSB-DIV-I</b>	For I depth units	<b>each 29</b>
<b>GRSB-DIV-O</b>	For O depth units	<b>each 34</b>

▼ See page 148 for Control Box cutout dimensions

**FOOD PANS AND TRIVETS – PAGE 245**  
**COLORS AND FINISHES – INSIDE BACK COVER**

GRSB-72-I with Channel Dividers (vertical, with notches) and Rods (horizontal)



GRSB-FLUSH-ITC



GRSB-FLUSH-TSTAT

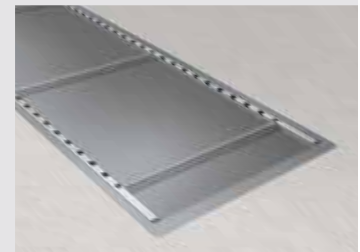

**NOTE:** Install Remote Box outside Heat Zone or damage will occur.



July 1, 2024

## Glo-Ray® Built-In Rectangular Flush Top Aluminum Heated Shelves

Add heat to your serving surface with the Glo-Ray Rectangular Heated Shelf Built-In with Flush Top. The Hardcoat Aluminum surface and blanket-type element provides uniform heat to extend your food holding time.

- Uniform heat distribution with Hardcoat Aluminum surface and blanket-type element
- Includes Control Box with 3' conduit and 6' cord and plug
- Thermostatically-controlled heated base
- Standard controller includes control thermostat, illuminated power switch and mounting brackets
- Model widths from 25½" to 73½"
- Optional Stainless Steel surface
- For use in countertops up to 1¼" thick



**GRSBF-60-0** built into a Bermuda Sand simulated stone countertop with accessory pans, shown below a **GR2AL-96D** Strip Heater in *Designer Black* with optional Sneeze Guards

### GLO-RAY BUILT-IN RECTANGULAR FLUSH TOP ALUMINUM HEATED SHELVES

Model M	Dimensions W x D x H	Cut-Out Dimensions		Voltage Single Phase	Watts	Approx. Ship Weight	List Price
		Min.-Max. Width	Min.-Max. Depth				
GRSBF-24-F	25½" x 17" x 2¼"	24½"-24¾"	16"-16¼"	120	420	28 lbs.	\$1841
GRSBF-24-I	25½" x 21" x 2¼"	24½"-24¾"	20"-20¼"	120	550	27 lbs.	1848
GRSBF-24-S	25½" x 25½" x 2¼"	24½"-24¾"	24½"-24¾"	120	680	32 lbs.	1958
GRSBF-24-O	25½" x 31½" x 2¼"	24½"-24¾"	30½"-30¾"	120	790	35 lbs.	2007
GRSBF-30-F	31½" x 17" x 2¼"	30½"-30¾"	16"-16¼"	120	505	24 lbs.	1961
GRSBF-30-I	31½" x 21" x 2¼"	30½"-30¾"	20"-20¼"	120	665	30 lbs.	1969
GRSBF-30-S	31½" x 25½" x 2¼"	30½"-30¾"	24½"-24¾"	120	815	33 lbs.	2121
GRSBF-30-O	31½" x 31½" x 2¼"	30½"-30¾"	30½"-30¾"	120	950	37 lbs.	2185
GRSBF-36-F	37½" x 17" x 2¼"	36½"-36¾"	16"-16¼"	120	590	32 lbs.	2085
GRSBF-36-I	37½" x 21" x 2¼"	36½"-36¾"	20"-20¼"	120	780	30 lbs.	2094
GRSBF-36-S	37½" x 25½" x 2¼"	36½"-36¾"	24½"-24¾"	120	950	35 lbs.	2361
GRSBF-36-O	37½" x 31½" x 2¼"	36½"-36¾"	30½"-30¾"	120	1110	37 lbs.	2433
GRSBF-42-F	43½" x 17" x 2¼"	42½"-42¾"	16"-16¼"	120	685	38 lbs.	2188
GRSBF-42-I	43½" x 21" x 2¼"	42½"-42¾"	20"-20¼"	120	885	32 lbs.	2199
GRSBF-42-S	43½" x 25½" x 2¼"	42½"-42¾"	24½"-24¾"	120	1090	40 lbs.	2586
GRSBF-42-O	43½" x 31½" x 2¼"	42½"-42¾"	30½"-30¾"	120	1270	48 lbs.	2672
GRSBF-48-F	49½" x 17" x 2¼"	48½"-48¾"	16"-16¼"	120	770	35 lbs.	2305
GRSBF-48-I	49½" x 21" x 2¼"	48½"-48¾"	20"-20¼"	120	1000	40 lbs.	2316
GRSBF-48-S	49½" x 25½" x 2¼"	48½"-48¾"	24½"-24¾"	120	1225	42 lbs.	2782
GRSBF-48-O	49½" x 31½" x 2¼"	48½"-48¾"	30½"-30¾"	120	1430	48 lbs.	2879
GRSBF-54-I	55½" x 21" x 2¼"	54½"-54¾"	20"-20¼"	120	1110	41 lbs.	2433
GRSBF-60-F	61½" x 17" x 2¼"	60½"-60¾"	16"-16¼"	120	950	41 lbs.	2543
GRSBF-60-I	61½" x 21" x 2¼"	60½"-60¾"	20"-20¼"	120	1220	48 lbs.	2554
GRSBF-60-S	61½" x 25½" x 2¼"	60½"-60¾"	24½"-24¾"	120	1500	55 lbs.	3255
GRSBF-60-O	61½" x 31½" x 2¼"	60½"-60¾"	30½"-30¾"	120	1750	64 lbs.	3346
GRSBF-66-I	67½" x 21" x 2¼"	66½"-66¾"	20"-20¼"	120	1330	49 lbs.	2656
GRSBF-72-F	73½" x 17" x 2¼"	72½"-72¾"	16"-16¼"	120	1130	44 lbs.	2748
GRSBF-72-I	73½" x 21" x 2¼"	72½"-72¾"	20"-20¼"	120	1440	52 lbs.	2760
GRSBF-72-S	73½" x 25½" x 2¼"	72½"-72¾"	24½"-24¾"	120	1750	59 lbs.	3667
GRSBF-72-O	73½" x 31½" x 2¼"	72½"-72¾"	30½"-30¾"	208, 240	2070	68 lbs.	3817

M Recommended for use in a metallic countertop. For other surfaces, verify the material is suitable for temperatures up to 200°F. Hatco is not responsible for counter damage caused by heat from the warmer.

#### All Glo-Ray Built-In Rectangular Flush Top Aluminum Heated Shelf Models Feature:

Plugs: All models ending in -F and -I and models 24" through 48" wide ending in -S and -O: NEMA 5-15P.

GRSBF-60-S, GRSBF-60-O and GRSBF-72-S: NEMA 5-20P. GRSBF-72-O: NEMA 6-15P.

Usable Heated Shelf Space: Width of unit minus 1½" x depth of unit minus 1½". Cord Location: Cord is attached to Control Box.



Standard Control Box

**NOTE:** For any size GRSBF, the next larger size GRA or GR2A Strip Heater will fit over the top. For example, a GRSBF-30 will require a GRA-36 or GR2A-36. The GRA will have a tight fit to the frame of the base. The GR2A will have approx a 4" space.

**NOTE:** Install Remote Box outside Heat Zone or damage will occur.



GRSBF-FLUSH-ITC



GRSBF-FLUSH-TSTAT

### OPTIONS (available at time of purchase only)

Designer Color Bezel (Flush Mount Control Box, Bezel only) – Stainless Steel standard – Non-standard colors are non-returnable – \$47

	RED	Warm Red	WHITE	White Granite	BLACK	Black	NAVY	Navy Blue	
	GRAY	Gray Granite	GREEN	Hunter Green	COPPER	Antique Copper			
GRSBF-SS	Stainless Steel surface in lieu of Hardcoat Aluminum (GRSBF models only)								No Charge
GRSBF-FLUSH-ITC	Flush Mount recessed Electronic Control Box with lighted On/Off rocker switch and angled recessed controls (6 <sup>13</sup> / <sub>32</sub> " W x 7 <sup>13</sup> / <sub>16</sub> " H x 4 <sup>13</sup> / <sub>16</sub> " D) ▼								\$200
GRSBF-FLUSH-TSTAT	Flush Mount recessed Thermostatic Control Box with lighted On/Off rocker switch and angled recessed controls (6 <sup>13</sup> / <sub>32</sub> " W x 7 <sup>13</sup> / <sub>16</sub> " H x 4 <sup>1</sup> / <sub>8</sub> " D) ▼								No Charge
COND-6	6' Conduit (3' standard) – used with Flush Mount ITC Control Boxes only								\$46
COND-10	10' Conduit (3' standard) – used with Flush Mount ITC Control Boxes only								89

▼ See page 148 for Control Box cutout dimensions

**FOOD PANS AND TRIVETS – PAGE 245**  
**COLORS AND FINISHES – INSIDE BACK COVER**

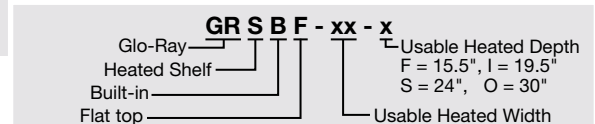



# Drawer Warmers

*Cafeterias • Convenience Stores  
Restaurants & Cafés • Clubs & Bars • Concessions*



**HDWTC-2** pg. 154



**HDW-2** with 6" deep food pans pg. 155



**HDW-2B** in optional *Designer Warm Red* pg. 155



**HDW-1.5R2** with optional touchscreen control  
pg. 155



**CDW-3N** pg. 157



**HRDW-2U-1** with standard utensil well and  
utensil pan (lid and pot not included) pg. 158



### Heated Drawer Warmers with Top Control

Hatco Drawer Warmers ensure optimal holding of a variety of products at safe temperatures, while minimizing moisture loss and texture change. Our unique blanket element design promotes uniform temperatures throughout the cavity. Each drawer features adjustable sliding vents. Touchscreen controller controls temperature and time for each drawer individually.

- Top-of-the-unit touchscreen controller is positioned at an angle for greater visibility
- Controller provides individual temperature control and hold timer for each drawer with visual and audio alerts
- Robust stainless steel construction inside and out
- Drawer frame is constructed of heavy duty, 12 gauge stainless steel and drawers slide on durable nylon rollers
- Easy-to-clean seamless interior core
- Snap out side panels make this unit easy to clean and service
- Drawer frame can accommodate varying pan configurations, including full size, half size or one-third size pans up to 6" deep, with or without lids
- Pans lift straight up, eliminating the need to tilt pan for removal
- USB port for easy software updates
- Unit comes standard with removeable 4" plastic legs



**HDWTC-2**  
shown with Accessory 2" casters  
(4" plastic legs are standard)

#### HEATED DRAWER WARMERS WITH TOP CONTROL

Model	Dimensions**		Voltage	Watts	Plug	Approx. Ship Weight	List Price
	W x D x H						
HDWTC-1	24 <sup>1</sup> / <sub>2</sub> "	25 <sup>5</sup> / <sub>8</sub> " x 11 <sup>11</sup> / <sub>16</sub> "	120	353	NEMA 5-15P	120 lbs	<b>\$4632</b>
HDWTC-2	24 <sup>1</sup> / <sub>2</sub> "	25 <sup>5</sup> / <sub>8</sub> " x 20 <sup>1</sup> / <sub>8</sub> "	120	704	NEMA 5-15P	178 lbs	<b>6723</b>
HDWTC-3	24 <sup>1</sup> / <sub>2</sub> "	25 <sup>5</sup> / <sub>8</sub> " x 28 <sup>7</sup> / <sub>16</sub> "	120	1055	NEMA 5-15P	217 lbs	<b>8825</b>

\*\* Add 1<sup>3</sup>/<sub>8</sub>" to depth for drawer handle. Height does not include standard 4" plastic legs.

#### All Heated Drawer Warmers with Top Control Models Feature:

Models Shipped with: One 6" deep food pan per drawer, 4" plastic legs, 6' cord and plug.  
Cord Location: top, back-left side, recessed to protect plug.

#### OPTIONS (available at time of purchase only)

<b>OS-PAN</b>	Oversized Drawer Frame and Pan (20" x 15" x 5") in lieu of standard Drawer with Pan	<b>per drawer \$162</b>
---------------	---	-------------------------

#### ACCESSORIES (available for purchase at any time)

<b>HDW-TRIVET</b>	Custom trivet raises food product 1/2" off bottom of full size pan (17 <sup>1</sup> / <sub>2</sub> " x 9 <sup>1</sup> / <sub>2</sub> " x 1 <sup>1</sup> / <sub>2</sub> ")	<b>\$ 70</b>
<b>HDW 6" LEG</b>	6" adjustable stainless steel Legs	<b>222</b>
<b>HDW-CASTER-2</b>	2" Dia. Casters – all swivel, 2 lock – adds 2 <sup>1</sup> / <sub>2</sub> " to height of unit	<b>271</b>
<b>HDW-CASTER-3</b>	3" Dia. Locking Casters – all swivel, all lock – adds 4 <sup>1</sup> / <sub>4</sub> " to height of unit	<b>271</b>
<b>HDW-CASTER-5</b>	5" Dia. Locking Casters – all swivel, all lock – adds 6 <sup>1</sup> / <sub>4</sub> " to height of unit	<b>325</b>

#### FOOD PANS AND TRIVETS – PAGE 245

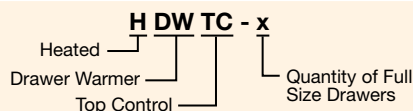

## Drawer Warmers

Hold everything from meat to vegetables to rolls in the Hatco Drawer Warmers. Built for tough kitchen duty with rugged construction and heavy-duty hardware, these warmers keep a variety of foods hot and fresh until served.

- Standard and narrow widths
- 1-, 2-, 3- or 4-drawer freestanding or 1-, 2- or 3-drawer built-in models
- Completely insulated individual cavities provide maximum energy efficiency (excludes HDW-1R2, -2R2)
- Each drawer has a food pan, recessed individual thermostatic control, temperature monitor, vent slides and power switch
- 12-gauge stainless steel heavy-duty drawer slides with nylon rollers
- Available with: oversized drawer frame, biscuit pan drawer, chip guard, casters, 6" adjustable stainless steel legs, water/spillage pan and splash baffle
- Standard width Drawer Warmer pans lift straight out of drawer (HDW-1N, -2N, -3N and HDW-1R2, -1.5R2, -2R2 models requiring tipping the pan to install)



HDW-3B



HDW-2 with Accessory 6" stainless steel legs



HDW-2R2 with optional touchscreen control



HDW-1.5R2 with optional touchscreen control

### FREESTANDING DRAWER WARMERS

Model	Dimensions <sup>↔</sup> W x D x H	Voltage Single Phase	Watts	Approx. Ship Weight	List Price
HDW-1	29½" x 22½" x 11"	120, 208, 240	450	97 lbs.	\$3042
HDW-2	29½" x 22½" x 21½"	120, 208, 240	900	168 lbs.	5164
HDW-3	29½" x 22½" x 31¼"	120, 208, 240	1350	232 lbs.	7292
HDW-4*	29½" x 22½" x 41½"	120, 208, 240	1800	296 lbs.	9625
HDW-1N	20¾" x 27" x 11"	120, 208, 240	450	83 lbs.	3042
HDW-2N	20¾" x 27" x 21½"	120, 208, 240	900	168 lbs.	5164
HDW-3N	20¾" x 27" x 31¼"	120, 208, 240	1350	223 lbs.	7292

↔ Add 1¾" to depth for drawer handle. Height does not include standard 4" plastic legs.  
\* Not available for Canada.

#### All Freestanding Drawer Warmer Models Feature:

Plug: NEMA 5-15P. (208 and 240V use NEMA 6-15P).

HDW-4 Shipped with: 6" stainless steel legs.

Models Shipped with: One 6" deep food pan per drawer, 4" plastic legs, 6' cord and plug.

Cord Location: Back of unit, lower left corner.

### SPLIT DRAWER WARMERS

Model	Dimensions <sup>↔</sup> W x D x H	Voltage Single Phase	Watts	Approx. Ship Weight	List Price
HDW-1R2	28¾" x 16½" x 10¾"	120	690	90 lbs.	\$4441
HDW-1.5R2	28¾" x 16½" x 15½"	120	990	112 lbs.	6306
HDW-2R2	28¾" x 16½" x 20"	120	1290	135 lbs.	6922

↔ Add 1¾" to depth for drawer handle. Height does not include standard 4" plastic legs.

#### All Split Drawer Warmer Models Feature:

Plug: NEMA 5-15P.

HDW-1R2 shipped with: Two 2½" deep food pans, 4" legs, 6' cord and plug.

HDW-1.5R2 shipped with: Three 2½" deep food pans, 4" legs, 6' cord and plug.

HDW-2R2 shipped with: Four 2½" deep food pans, 4" legs, 6' cord and plug.

Pan Capacity: 20¾"W x 12¾"D x 2½"H.

Cord Location: Back of unit, lower left corner.

### BUILT-IN DRAWER WARMERS

Model	Dimensions <sup>↔</sup> W x D x H	Voltage Single Phase	Watts	Approx. Ship Weight	List Price
HDW-1B	28¼" x 22¾" x 9¾"	120, 208, 240	450	88 lbs.	\$2927
HDW-2B	28¼" x 22¾" x 20"	120, 208, 240	900	159 lbs.	4947
HDW-3B	28¼" x 22¾" x 30½"	120, 208, 240	1350	232 lbs.	6965
HDW-1BN	19½" x 26¾" x 9¾"	120, 208, 240	450	88 lbs.	2927
HDW-2BN	19½" x 26¾" x 20"	120, 208, 240	900	159 lbs.	4947
HDW-3BN	19½" x 26¾" x 30½"	120, 208, 240	1350	232 lbs.	6965

↔ Add 1¾" to depth for drawer handle. Width and Height excludes front mounting flange.

#### All Built-In Drawer Warmer Models Feature:

Conduit: 4" flexible conduit.

Models Shipped with: One 6" deep food pan per drawer.

### OPTIONS AND ACCESSORIES – PAGE 156

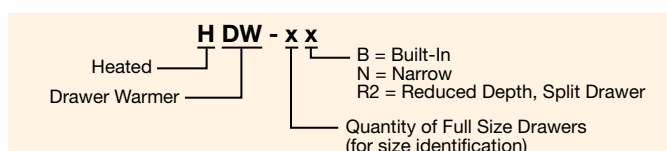

### BUILT-IN CUTOUT REQUIREMENTS

Model	Width	Depth <sup>▼</sup>	Height
HDW-1B	28¾"	24"	10½"
HDW-2B	28¾"	24"	20¼"
HDW-3B	28¾"	24"	30¾"
HDW-1BN	19¾"	28¾"	10½"
HDW-2BN	19¾"	28¾"	20¼"
HDW-3BN	19¾"	28¾"	30¾"

▼ Depth includes 1½" for conduit connector.

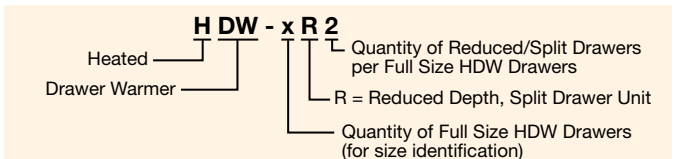

**OPTIONS** (available at time of purchase only)

**Designer Drawer Front colors per drawer (not available for HDW-1R2, -1.5R2, -2R2 models)**  
**Non-standard colors are non-returnable – Stainless steel standard**

<b>RED</b>	Warm Red	<b>\$80</b>
<b>BLACK</b>	Black	<b>80</b>
<b>GRAY</b>	Gray Granite	<b>80</b>
<b>WHITE</b>	White Granite	<b>80</b>
<b>NAVY</b>	Navy Blue	<b>80</b>
<b>GREEN</b>	Hunter Green	<b>80</b>
<b>COPPER</b>	Antique Copper	<b>80</b>
<b>HDW-TTC</b>	Temperature Control Timer – 6-channel control touchscreen display	<b>\$712</b>
<b>OS-PAN</b>	Oversized Drawer Frame and Pan (20" x 15" x 5") in lieu of standard Drawer with Pan, standard width models only (excludes HDW-1R2, -1.5R2, -2R2)	<b>per drawer 162</b>
<b>BIS DRAWER</b>	Biscuit Pan Drawer – accommodates two 18" x 13" Half-Size Sheet Pans (not included) in lieu of standard Drawer with Pan, standard width models only (excludes HDW-1R2, -1.5R2, -2R2)	<b>No Charge</b>
<b>HDW-CHIP</b>	Chip Guard (excludes HDW-1R2, -1.5R2, -2R2)	<b>per drawer 53</b>
<b>RD-NOVENT</b>	No Drawer Vents (HDW-1R2, -1.5R2, -2R2 only)	<b>No Charge</b>

**ACCESSORIES** (available for purchase at any time)

<b>HDW-TRIVET</b>	Custom trivet raises food product 1/2" off bottom of full size pan 17 1/2" x 9 1/2" x 1/2"	<b>\$ 70</b>
<b>HDW 6" LEG</b>	6" Adjustable Stainless Steel Legs, standard on HDW-4 (excludes HDW-1R2, -1.5R2, -2R2)	<b>222</b>
<b>HDW-CASTER-2</b>	2" Dia. Casters – all swivel, 2 lock – adds 2 1/4" to height of unit, HDW-1, -2, -3 models only (excludes HDW-1R2, -1.5R2, -2R2)	<b>271</b>
<b>HDW-CASTER-3</b>	3" Dia. Locking Casters – all swivel, all lock – adds 4 1/4" to height of unit, HDW-1, -2, -3 models only (excludes HDW-1R2, -1.5R2, -2R2)	<b>271</b>
<b>HDW-CASTER-5</b>	5" Dia. Locking Casters – all swivel, all lock – adds 6 1/4" to height of unit (excludes HDW-1R2, -1.5R2, -2R2)	<b>325</b>
<b>HDW-SPILL</b>	Water/Spillage Pan – one per drawer (excludes HDW-1R2, -1.5R2, -2R2 and BIS Drawer, and OS-Pan Options)	<b>308</b>
<b>HDW-SPLASH</b>	Splash Baffle – one per drawer (excludes HDW-1R2, -1.5R2, -2R2 and BIS Drawer, and OS-Pan Options)	<b>65</b>

**FOOD PANS AND TRIVETS – PAGE 245**  
**COLORS AND FINISHES – INSIDE BACK COVER**

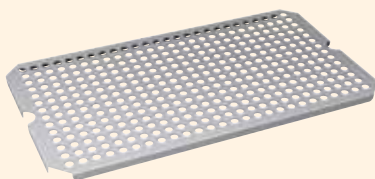

**HDW-TRIVET**



**CASTERS**  
**HDW-CASTER-2** all swivel, 2 lock  
**HDW-CASTER-3** all swivel, all lock  
**HDW-CASTER-5** all swivel, all lock



**HDW 6" LEG**

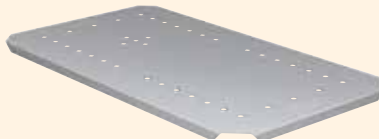

**HDW-SPLASH**



**HDW-TTC Option**  
 Shown: Temperature adjustment and timer touchscreen control



Biscuit Pan Drawer (pans not included)  
**BIS DRAWER** Option

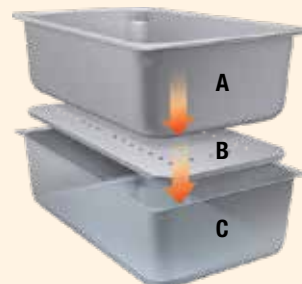

**Additional Humidity**  
 A. Stainless Steel Food Pan  
 B. Splash Baffle  
**HDW-SPLASH** accessory  
 C. Water/Spillage Pan (add 1/4" of water)  
**HDW-SPILL** accessory

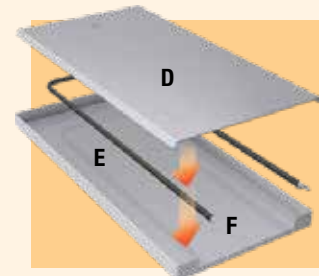

**Prevents chips from reaching the element**  
 D. Heat Shield (included)  
 E. Heating Element (included)  
 F. Chip Guard **HDW-CHIP** Option (Standard width shown)



## Convected Drawer Warmer

This drawer warmer is designed to keep a variety of food products hot and flavor-fresh until served. With a single non-humidified cavity and a single electronic temperature control, this unit provides even, dry heat for food products that do not require humidity. With insulated top, sides and back, they provide excellent energy efficiency.

- Digital electronic controller for easy programming
- Low velocity convected air system provides even temperature throughout the cabinet
- Tough, durable chrome handles that are angled to avoid contact from passing carts
- Narrow width fits most kitchen footprints
- Heavy-duty drawer slides with nylon rollers
- Includes three full-size pans
- Provides even, dry heat for food products that do not require humidity.



CDW-3N

### CONVECTED DRAWER WARMER

Model	Dimensions <sup>↔</sup> W x D x H	Voltage Single Phase	Watts	Approx. Ship Weight	List Price
CDW-3N	16 <sup>5</sup> / <sub>8</sub> " x 28 <sup>3</sup> / <sub>32</sub> " x 27 <sup>1</sup> / <sub>2</sub> "	120	1015	179 lbs.	\$6005

↔ Add 1<sup>3</sup>/<sub>8</sub>" to depth for drawer handle. Height does not include casters, which add 2<sup>1</sup>/<sub>2</sub>" to height.

**All Convected Drawer Warmer Models Feature:**

**Plug:** NEMA 5-15P.

**Models Shipped with:** One 6" deep food pan per drawer, low profile 2" diameter casters, 6' cord and plug.

**Cord Location:** Back of unit, top right corner.

**FOOD PANS AND TRIVETS – PAGE 245**

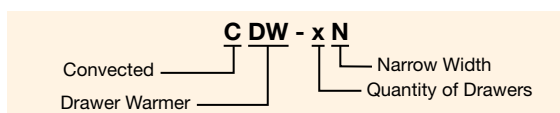



### Heated Rice Drawer Warmers

Hatco's Heated Rice Drawer Warmers are designed to keep rice hot and at desired consistency until served.

It holds rice in the same pot it's prepared in, reducing pan-to-pan transfer time and labor.

With a digital electronic temperature control, this unit provides even heat throughout the holding cavity.

With all around insulation, these drawer warmers provide excellent energy efficiency.

- Drawers accept Panasonic 23 cup rice pots (pots and lids not available)
- Drawers accept Town 30 cup rice pots with accessory Town 30 cup pot drawer adapters (pots and lids not available)
- Allows one pot per drawer of cooked rice for long term holding, with the option of serving from third pot in top heated well (HRDW-2U-1 only)

- Stainless steel construction, including back panel, handles the rigors of daily kitchen use
- Heavy-duty drawers and robust telescopic drawer slides makes pan removal easy and efficient
- Stainless steel utensil well and utensil pan included with HRDW-2U and HRDW-2U-1 models only
- Adjustable t-stat with knob for optimal rice holding in top well (HRDW-2U-1 only)
- Raised beveled edge on top of HRDW-2, HRDW-2U models only

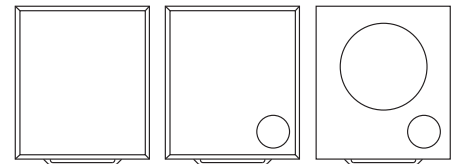

HRDW-2

HRDW-2U

HRDW-2U-1

HRDW-2U-1 with accessory hinged lid and standard utensil well and utensil pan

### HEATED RICE DRAWER WARMERS

Model	Dimensions** W x D x H	Voltage Single Phase	Watts	Amps	Approx. Ship Weight	List Price
HRDW-2	20¼" x 22 <sup>13</sup> / <sub>16</sub> " x 35 <sup>1</sup> / <sub>8</sub> "	120	700	5.8	153 lbs.	\$5744
HRDW-2U	20¼" x 22 <sup>13</sup> / <sub>16</sub> " x 35 <sup>1</sup> / <sub>8</sub> "	120	700	5.8	150 lbs.	5982
HRDW-2U-1	20¼" x 22 <sup>13</sup> / <sub>16</sub> " x 35 <sup>1</sup> / <sub>8</sub> "	120	1150	9.6	150 lbs.	6707

\* Add 1<sup>3</sup>/<sub>8</sub>" to depth for drawer handle. Height does not include standard casters, which add 2.5" to height of unit

#### All Heated Rice Drawer Warmer Models Feature:

Plug: NEMA 5-15P.

Models Shipped with: Utensil pan (HRDW-2U and HRDW-2U-1 only), 4" casters, 6' cord and plug.

Cord Location: Back of unit, upper left corner.

### ACCESSORIES (available for purchase at any time)

HRDW-LID	Hinged aluminum lid for top rice well (HRDW-2U-1 only)	\$260
HRDW-TOWN30	One Drawer Adapter for Town 30 cup rice pots (one per drawer required)	154



HRDW-LID

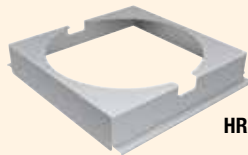

HRDW-TOWN30

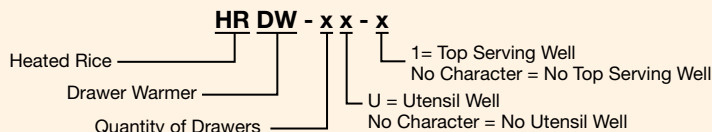

# Merchandisers

*Cafeterias • Convenience Stores  
Supermarkets & Delis • Restaurants & Cafés  
Clubs & Bars • Catering • Concessions*



**FS3HAC-2426** signs not included *pg. 160*



**PDH-55T** and **PSH-55D** shown on operator side *pg. 162*



**GRPWS-4818T** with base heat only (signs not included) *pg. 163*



**GR2SDS-48D** *Designer* Merchandiser with standard Black inset panels and corner caps *pg. 168*



**HZMS-36D** in standard *Designer* Black and optional Red LED accent lighting *pg. 171*



**GR3SDS-27TCT** in optional *Designer* Gray Granite *pg. 175*



**GRCMW-1DH** in optional Bermuda Sand *pg. 176*



**GRCD-2PD** with optional self-closing flip-up doors and *Designer* Warm Red *pg. 177*



**FSCDH-2PD** in standard *Designer* Black, sign holder (sign not included), 3-sided skirt, perforated shelf, and Simulated Stone Night Sky base. *pg. 179*



## Flav-R-Savor® Heated Air Curtain Merchandisers

The newest models of our patented Flav-R-Savor® Heated Air Curtain Merchandisers has no front doors, allowing customers easy access to fresh hot products. Heated air at the front of the cabinet is forced downward, forming a "curtain" of heated air. The heated air is then drawn toward the rear of the cabinet, warming each shelf gently and evenly.

- Perfect for wrapped or unwrapped food product.
- Consistent even temperatures result in longer quality hold times compared to traditional merchandisers
- The air temperature range is 70° - 175°F
- Easy to use digital controls
- Standard *Designer Powercoat Black* finish inside and outside for an uniform and sleek look to compliment any décor
- LED lighting on top front and sides, to create balanced lighting which showcases food product
- Removable shelves can be installed to be slanted or horizontal, with removable sign holders on each
- Front crumb tray lifts and pivots, and removable glass sides make for easy upkeep

Merchandisers



**FS3HAC-2426** with optional square side cut-outs and top sign holder (signs not included)



**FS3HAC-3626** shelf signs not included



**FS3HAC-4226** with optional tiered shelves

### HEATED AIR CURTAIN MERCHANDISERS

Model	Dimensions (W x D x H) height includes legs	Shelf Dimensions W x D	Voltage	Watts	Amps	Plugs	Approx. Ship Weight	List Price
<b>FS3HAC-2426</b>	24" x 27 <sup>3</sup> / <sub>8</sub> " x 38"	20 <sup>1</sup> / <sub>8</sub> " x 17"	120	1800	15.0	NEMA 5-15P*	183 lbs.	<b>\$10393</b>
<b>FS3HAC-3026</b>	30" x 27 <sup>3</sup> / <sub>8</sub> " x 38"	26 <sup>1</sup> / <sub>8</sub> " x 17"	120/208-240	3340	13.8	NEMA 14-20P	211 lbs.	<b>11319</b>
<b>FS3HAC-3626</b>	36" x 27 <sup>3</sup> / <sub>8</sub> " x 38"	32 <sup>1</sup> / <sub>8</sub> " x 17"	120/208-240	3340	13.8	NEMA 14-20P	227 lbs.	<b>12190</b>
<b>FS3HAC-4226</b>	42" x 27 <sup>3</sup> / <sub>8</sub> " x 38"	38" x 17"	120/208-240	3430	14.3	NEMA 14-20P	274 lbs.	<b>13063</b>

\* Canadian Model uses NEMA 5-20P.

#### All Heated Air Curtain Merchandiser Models Feature:

Models Shipped with: **FS3HAC-2426, -3026:** One, swing-out left hinged rear door, three removeable shelves with sign holder in front, crumb tray, 4" legs and a 6' cord and plug.  
**FS3HAC-3626, -4226:** Sliding glass rear door, three removeable shelves with sign holder in front, crumb tray, 4" legs and a 6' cord and plug.

Cord Location: Servers side, bottom left.

### OPTIONS AND ACCESSORIES – PAGE 161

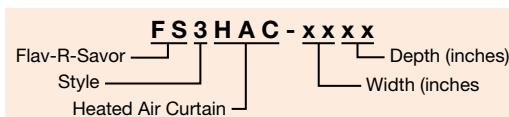





FS3HAC-2426 with optional square side cut-outs and top sign holder (signs not included)

Merchandisers

**OPTIONS** (available at time of purchase only)

<b>SIDECONTROL</b>	Right- or Left-Hand Side Controls - must specify side at time of order	<b>No Charge</b>
<b>RTHGDOOR</b>	Right Hinged Access Door in lieu of Left Hinged Access Door (FS3HAC-2426, -3026 models only)	<b>No Charge</b>
<b>TIERSHELVES</b>	Tiered shelves in lieu of standard depth shelves	<b>No Charge</b>
<b>PRODSTOP-STDSH</b>	Side product stops for standard depth shelves	<b>\$135</b>
<b>PRODSTOP-TIERSH</b>	Side product stops for tiered shelves	<b>15</b>
<b>SQSIDEPANEL</b>	Square side cut-outs in lieu of curved side cut outs	<b>No Charge</b>
<b>SIGN24</b>	Sign Holder for the FS3HAC-2426. Sign dimensions: 23 <sup>3</sup> / <sub>8</sub> " x 6 <sup>3</sup> / <sub>4</sub> "	<b>49</b>
<b>SIGN30</b>	Sign Holder for the FS3HAC-3026. Sign dimensions: 29 <sup>1</sup> / <sub>8</sub> " x 6 <sup>3</sup> / <sub>4</sub> "	<b>51</b>
<b>SIGN36</b>	Sign Holder for the FS3HAC-3626. Sign dimensions: 35 <sup>1</sup> / <sub>8</sub> " x 6 <sup>3</sup> / <sub>4</sub> "	<b>53</b>
<b>SIGN42</b>	Sign Holder for the FS3HAC-4226. Sign dimensions: 41 <sup>7</sup> / <sub>8</sub> " x 6 <sup>3</sup> / <sub>4</sub> "	<b>55</b>
<b>LOCKPLUG</b>	NEMA L14-20P Locking plug in lieu of NEMA 14-20P (FS3HAC-3026, -3626, -4226 units only)	<b>190</b>
<b>Side Stops/Divider Rails – Kits for order at time of purchase only –</b>		
<b>RAIL-STD24</b>	15 rails for 24 standard model (5 per shelf)	<b>\$472</b>
<b>RAIL-STD30</b>	18 rails for 30 standard model (6 per shelf)	<b>566</b>
<b>RAIL-STD36</b>	21 rails for 36 standard model (7 per shelf)	<b>660</b>
<b>RAIL-STD42</b>	24 rails for 42 standard model (8 per shelf)	<b>754</b>
<b>RAIL-TR24</b>	15 rails for 24 tiered model (5 per shelf)	<b>450</b>
<b>RAIL-TR30</b>	18 rails for 30 tiered model (6 per shelf)	<b>541</b>
<b>RAIL-TR36</b>	21 rails for 36 tiered model (7 per shelf)	<b>632</b>
<b>RAIL-TR42</b>	24 rails for 42 tiered model (8 per shelf)	<b>723</b>

**ACCESSORIES** (available for purchase at any time)

**Side Stops/Divider Rails – sold Individually –**

<b>RAIL-TOPT-BLACK</b>	Top tiered shelf in <i>Designer Black</i>	<b>each \$29</b>
<b>RAIL-MIDT-BLACK</b>	Middle tiered shelf in <i>Designer Black</i>	<b>each 30</b>
<b>RAIL-STD-BLACK</b>	Standard shelf and tiered bottom shelf in <i>Designer Black</i>	<b>each 31</b>



**RAIL-MIDT-BLACK** Use as side stops or divider rails

## Product Heated Shelves

Perfect for sliced pizza sales on the bottom, and boxed carry-out pizzas on the top. Durable stainless steel construction with blanket elements on all shelf bases make for easy cleaning. The bottom, three shelf PDH-55T has energy efficient LED lights to showcase food to customers and encouraging impulse sales. The top dual shelf PSH-55D holds the carry-out orders.

### PDH-55T (bottom three-shelf unit)

- Holds up to nine, 18" diameter pizzas
- Base and overhead heat for consistent and accurate holding of unwrapped pizzas for impulse sales
- Optional front glass for easy viewing by the customer
- Single on/off switch to control temperature for all shelves
- Standard side panel glass swings out for easy cleaning

### PSH-55D (top two-shelf unit)

- Enclosed except for operator side, with base heat only, for boxed carry out sales
- Single on/off switch to control temperature for all shelves
- Customer side can be used for magnetic signage (signs not included)
- Brackets and cord clips included to attach to the top of the PDH-55T



Customer side shown  
**PSH-55D** top unit  
**PSD-55T** bottom unit with optional front glass panels



Operator side shown  
**PSH-55D** top unit  
**PSD-55T** bottom unit with optional front glass panels

### PRODUCT HEATED SHELVES

Model	Dimensions W x D x H	Usable Heated Shelf Space (W x D)	Voltage	Watts	Amps	Plug	Approx. Ship Weight	List Price
<b>Dual Shelf</b>								
<b>PSH-55D</b>	54 $\frac{5}{8}$ " x 20" x 16"	51 $\frac{1}{2}$ " x 18 $\frac{3}{4}$ "	120	300	2.54	NEMA 5-15P	193 lbs.	<b>\$4842</b>
<b>Triple Shelf</b>								
<b>PDH-55T</b>	54 $\frac{1}{2}$ " x 20 $\frac{1}{8}$ " x 31 $\frac{1}{8}$ " ‡	51 $\frac{1}{2}$ " x 18 $\frac{3}{4}$ "	120/208-240	4100	17.5	NEMA L14-20P*	168 lbs.	<b>\$10892</b>

‡ Height includes 2.5" legs.

\* Canadian models use NEMA 14-30 or NEMA L14-30.

#### All Product Heated Shelf Models Feature:

Cord Location: PSH-55D: Server side, bottom right

PDH-55T: Server side, bottom right on base.

### OPTIONS (available at time of purchase only)

<b>GLSSPNL</b>	Glass Panels on customer side on PDH-55T only	<b>\$968</b>
----------------	---	--------------

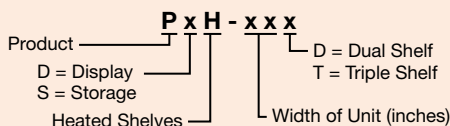

## Glo-Ray® Pizza Warmers

Convenient for self-serve and quick-serve areas. The Hatco Glo-Ray® Pizza Warmers with base heat only hold boxed or bagged pizzas. Available in one, two, three or four shelf configuration, perfect for high volume applications.

- Box stop doubles as the sign holder (signs not included), a standard feature (excluding base only unit)
- Constructed of aluminum and stainless steel with tempered glass side panels (excluding base only unit)
- Separate power switch for each thermostatically-controlled shelf
- Dual and Triple Shelf units have LED lights, Quadruple Shelf units have incandescent lights



**GRPWS-2424**  
with base heat only



**GRPWS-2418D**  
(signs not included)



**GRPWS-2424T**  
with optional  
*Designer Black*



**GRPWS-2418Q**  
(signs not included)

Merchandisers

### SLANT DISPLAY WARMERS WITH BASE HEAT ONLY

Model	No. of Bulbs, Divider Rods	Dimensions (W x D x H) <i>Height includes legs</i>	Voltage Single Phase	Usable Heated Shelf Space (W x D)	Watts	Plug	Approx. Ship Weight	List Price
<b>Base Only</b>								
GRPWS-2424 †	0,5	23 <sup>7</sup> / <sub>8</sub> " x 25" x 7 <sup>7</sup> / <sub>8</sub> "	120	22 <sup>1</sup> / <sub>2</sub> " x 21"	345	NEMA 5-15P	40 lbs.	<b>\$2354</b>
GRPWS-3624 †	0,7	35 <sup>7</sup> / <sub>8</sub> " x 25" x 7 <sup>7</sup> / <sub>8</sub> "	120	34 <sup>1</sup> / <sub>2</sub> " x 21"	505	NEMA 5-15P	45 lbs.	<b>2595</b>
GRPWS-4824	0,9	47 <sup>7</sup> / <sub>8</sub> " x 25" x 10 <sup>7</sup> / <sub>8</sub> "	120	46 <sup>1</sup> / <sub>2</sub> " x 21"	660	NEMA 5-15P	60 lbs.	<b>2906</b>
<b>Dual Shelf</b>								
GRPWS-2418D	4,0	23 <sup>7</sup> / <sub>8</sub> " x 20 <sup>1</sup> / <sub>8</sub> " x 22 <sup>5</sup> / <sub>8</sub> "	120	22 <sup>1</sup> / <sub>2</sub> " x 17 <sup>3</sup> / <sub>4</sub> "	720	NEMA 5-15P	76 lbs.	<b>\$4701</b>
GRPWS-3618D	6,0	35 <sup>7</sup> / <sub>8</sub> " x 20 <sup>1</sup> / <sub>8</sub> " x 22 <sup>5</sup> / <sub>8</sub> "	120	34 <sup>1</sup> / <sub>2</sub> " x 17 <sup>3</sup> / <sub>4</sub> "	1080	NEMA 5-15P	91 lbs.	<b>5311</b>
GRPWS-4818D ✓	8,0	47 <sup>7</sup> / <sub>8</sub> " x 20 <sup>1</sup> / <sub>8</sub> " x 22 <sup>5</sup> / <sub>8</sub> "	120	46 <sup>1</sup> / <sub>2</sub> " x 17 <sup>3</sup> / <sub>4</sub> "	1440	NEMA 5-20P	136 lbs.	<b>5896</b>
GRPWS-2424D	4,0	23 <sup>7</sup> / <sub>8</sub> " x 26 <sup>1</sup> / <sub>8</sub> " x 23 <sup>3</sup> / <sub>8</sub> "	120	22 <sup>1</sup> / <sub>2</sub> " x 23 <sup>3</sup> / <sub>4</sub> "	1200	NEMA 5-15P	108 lbs.	<b>5091</b>
GRPWS-3624D*	6,0	35 <sup>7</sup> / <sub>8</sub> " x 26 <sup>1</sup> / <sub>8</sub> " x 23 <sup>3</sup> / <sub>8</sub> "	120	34 <sup>1</sup> / <sub>2</sub> " x 23 <sup>3</sup> / <sub>4</sub> "	1800	NEMA 5-15P	136 lbs.	<b>5787</b>
GRPWS-4824D	8,0	47 <sup>7</sup> / <sub>8</sub> " x 26 <sup>1</sup> / <sub>8</sub> " x 23 <sup>3</sup> / <sub>8</sub> "	120/208-240	46 <sup>1</sup> / <sub>2</sub> " x 23 <sup>3</sup> / <sub>4</sub> "	2390	NEMA L14-20P	177 lbs.	<b>6474</b>
<b>Triple Shelf</b>								
GRPWS-2418T	6,0	23 <sup>7</sup> / <sub>8</sub> " x 20 <sup>1</sup> / <sub>8</sub> " x 29 <sup>3</sup> / <sub>4</sub> "	120	22 <sup>1</sup> / <sub>2</sub> " x 17 <sup>3</sup> / <sub>4</sub> "	1440	NEMA 5-15P	98 lbs.	<b>\$6051</b>
GRPWS-3618T	9,0	35 <sup>7</sup> / <sub>8</sub> " x 20 <sup>1</sup> / <sub>8</sub> " x 29 <sup>3</sup> / <sub>4</sub> "	120/208-240	34 <sup>1</sup> / <sub>2</sub> " x 17 <sup>3</sup> / <sub>4</sub> "	2160	NEMA L14-20P	136 lbs.	<b>6936</b>
GRPWS-4818T	12,0	47 <sup>7</sup> / <sub>8</sub> " x 20 <sup>1</sup> / <sub>8</sub> " x 29 <sup>3</sup> / <sub>4</sub> "	120/208-240	46 <sup>1</sup> / <sub>2</sub> " x 17 <sup>3</sup> / <sub>4</sub> "	2880	NEMA L14-20P	175 lbs.	<b>8008</b>
GRPWS-2424T*	6,0	23 <sup>7</sup> / <sub>8</sub> " x 26 <sup>1</sup> / <sub>8</sub> " x 30 <sup>3</sup> / <sub>4</sub> "	120	22 <sup>1</sup> / <sub>2</sub> " x 23 <sup>3</sup> / <sub>4</sub> "	1800	NEMA 5-15P	116 lbs.	<b>6619</b>
GRPWS-3624T*	9,0	35 <sup>7</sup> / <sub>8</sub> " x 26 <sup>1</sup> / <sub>8</sub> " x 30 <sup>3</sup> / <sub>4</sub> "	120/208-240	34 <sup>1</sup> / <sub>2</sub> " x 23 <sup>3</sup> / <sub>4</sub> "	2700	NEMA L14-20P	167 lbs.	<b>7851</b>
GRPWS-4824T**	12,0	47 <sup>7</sup> / <sub>8</sub> " x 26 <sup>1</sup> / <sub>8</sub> " x 30 <sup>3</sup> / <sub>4</sub> "	120/208-240	46 <sup>1</sup> / <sub>2</sub> " x 23 <sup>3</sup> / <sub>4</sub> "	3585	NEMA L14-20P	227 lbs.	<b>8857</b>
<b>Quadruple Shelf</b>								
GRPWS-2418Q	8,0	23 <sup>7</sup> / <sub>8</sub> " x 20 <sup>1</sup> / <sub>8</sub> " x 36 <sup>7</sup> / <sub>8</sub> "	120/208-240	22 <sup>1</sup> / <sub>2</sub> " x 17 <sup>3</sup> / <sub>4</sub> "	1920	NEMA L14-20P	119 lbs.	<b>\$ 7460</b>
GRPWS-3618Q	12,0	35 <sup>7</sup> / <sub>8</sub> " x 20 <sup>1</sup> / <sub>8</sub> " x 36 <sup>7</sup> / <sub>8</sub> "	120/208-240	34 <sup>1</sup> / <sub>2</sub> " x 17 <sup>3</sup> / <sub>4</sub> "	2880	NEMA L14-20P	157 lbs.	<b>8852</b>
GRPWS-4818Q	16,0	47 <sup>7</sup> / <sub>8</sub> " x 20 <sup>1</sup> / <sub>8</sub> " x 36 <sup>7</sup> / <sub>8</sub> "	120/208-240	46 <sup>1</sup> / <sub>2</sub> " x 17 <sup>3</sup> / <sub>4</sub> "	3840	NEMA L14-20P	214 lbs.	<b>10041</b>
GRPWS-2424Q	8,0	23 <sup>7</sup> / <sub>8</sub> " x 26 <sup>1</sup> / <sub>8</sub> " x 37 <sup>7</sup> / <sub>8</sub> "	120/208-240	22 <sup>1</sup> / <sub>2</sub> " x 23 <sup>3</sup> / <sub>4</sub> "	2400	NEMA L14-20P	151 lbs.	<b>8188</b>
GRPWS-3624Q	12,0	35 <sup>7</sup> / <sub>8</sub> " x 26 <sup>1</sup> / <sub>8</sub> " x 37 <sup>7</sup> / <sub>8</sub> "	120/208-240	34 <sup>1</sup> / <sub>2</sub> " x 23 <sup>3</sup> / <sub>4</sub> "	3600	NEMA L14-20P	214 lbs.	<b>9749</b>
GRPWS-4824Q**	16,0	47 <sup>7</sup> / <sub>8</sub> " x 26 <sup>1</sup> / <sub>8</sub> " x 37 <sup>7</sup> / <sub>8</sub> "	120/208-240	46 <sup>1</sup> / <sub>2</sub> " x 23 <sup>3</sup> / <sub>4</sub> "	4780	NEMA L14-20P	277 lbs.	<b>11318</b>

† Height includes 1" legs. Other models ship with 4" legs.

✓ Also available in 120/208-240V.

\* Canadian models use NEMA 5-20P.

\*\* Canadian models use NEMA L14-3

### OPTIONS AND ACCESSORIES – PAGE 164

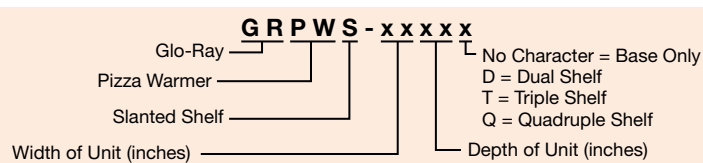



GRPWS-4818T (signs not included)

**OPTIONS** (available at time of purchase only)

**Designer Colors – Non-standard colors are non-returnable – Stainless Steel standard –**

<b>RED</b>	Warm Red	<b>\$506</b>
<b>BLACK</b>	Black	<b>506</b>
<b>GRAY</b>	Gray Granite	<b>506</b>
<b>WHITE</b>	White Granite	<b>506</b>
<b>NAVY</b>	Navy Blue	<b>506</b>
<b>GREEN</b>	Hunter Green	<b>506</b>
<b>COPPER</b>	Antique Copper	<b>506</b>
<b>HAL</b>	60 Watt Halogen Bulb in lieu of Standard Display Light	<b>each \$69</b>

**LED Lights in lieu of Standard Display Lights – Dual and Triple Shelf models only –**

<b>LED-WW-24</b>	Warm White LED lighting for 24 width models	<b>No Charge</b>
<b>LED-WW-36</b>	Warm White LED lighting for 36 width models	<b>No Charge</b>
<b>LED-WW-48</b>	Warm White LED lighting for 48 width models	<b>No Charge</b>

**ACCESSORIES** (available for purchase at any time)

**Chef LED 120V adjustable bulb – bulbs must be rotated down –**

<b>CLED-3000-120</b>	Similar to warm Halogen light	
<b>CLED-4000-120</b>	Similar to cool Fluorescent light	<b>each \$139</b>

**COLORS AND FINISHES – INSIDE BACK COVER**

**RECOMMENDED SIGN DIMENSIONS**

- Excluding base only units -

**GRPWS-24's:** 22¼" x 2¾" x 1/8"

**GRPWS-36's:** 34¼" x 2¾" x 1/8"

**GRPWS-48's:** 46¼" x 2¾" x 1/8"

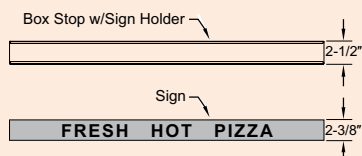



## Glo-Ray® Merchandising Warmers

Designed with both a slanted and horizontal shelf, Glo-Ray® Merchandising Warmers offer the convenience of customer self-serve with the efficiency of preparing and holding product in advance for peak serving periods.

- Warmer includes a slant and horizontal shelf for merchandising a variety of products
- Standard Indicating Temperature Control (ITC) enhances accuracy and provides digital readout of temperatures
- Thermostatically-controlled hardcoated heated base to extend holding times
- Pre-focused infrared top heat directs heat to the outer edges where heat loss is greatest
- Product divider rods and 4" legs included
- Shatter-resistant incandescent lights illuminate the holding areas and emphasize the product
- Low watt models feature low watt overhead heat on the top shelf to hold popcorn. For fried food holding - select high watt models
- High watt models feature high watt overhead heat on top shelf to hold fried foods. For popcorn holding - select the lower watt models



**GRSDS/H-36D** with lower slant and upper horizontal shelf. Shown with optional 15" clearance - standard clearance is 12".



**GRSDS/H-36DHW** with lower slant and upper horizontal shelf. Shown with standard clearance of 12".

Merchandisers

### SLANT/HORIZONTAL DISPLAY WARMERS – DUAL SHELVES

Model	No. of Bulbs, Divider Rods	Dimensions W x D x H	Voltage Single Phase	Watts	Plug	Approx. Ship Weight	List Price
<b>Low Watt - Top shelf overhead heat is designed to hold popcorn.</b>							
<b>GRSDS/H-30D*</b>	4, 12	30" x 24¼" x 33½"	120	1530	NEMA 5-15P	140 lbs.	<b>\$7545</b>
<b>GRSDS/H-36D</b>	4, 14	36" x 24¼" x 33½"	120	1810	NEMA 5-20P	158 lbs.	<b>7962</b>
<b>GRSDS/H-41D</b>	6, 16	41" x 24¼" x 33½"	120/208-240	2120	NEMA L14-20P	178 lbs.	<b>8522</b>
<b>High Watt - Top shelf overhead heat is designed to hold fries and sandwiches.</b>							
<b>GRSDS/H-30DHW<sup>▲</sup></b>	4, 12	30" x 24¼" x 33½"	120/208-240	2450	NEMA L14-20P	140 lbs.	<b>\$7877</b>
<b>GRSDS/H-36DHW<sup>▲</sup></b>	4, 14	36" x 24¼" x 33½"	120/208-240	2910	NEMA L14-20P	158 lbs.	<b>8294</b>
<b>GRSDS/H-41DHW<sup>▲</sup></b>	6, 16	41" x 24¼" x 33½"	120/208-240	3360	NEMA L14-20P	178 lbs.	<b>8854</b>

\* Canadian model uses NEMA 5-20P.

▲ High wattage on top shelf only.

#### All Slant/Horizontal Display Warmer Models Feature:

Cord Location – Back Counter Display Models: Server side, bottom right corner.

### OPTIONS (available at time of purchase only)

#### Designer Colors – Non-standard colors are non-returnable

– Glossy Gray standard –

<b>RED</b>	Warm Red	<b>\$506</b>
<b>BLACK</b>	Black	<b>506</b>
<b>GRAY</b>	Gray Granite	<b>506</b>
<b>WHITE</b>	White Granite	<b>506</b>
<b>NAVY</b>	Navy Blue	<b>506</b>
<b>GREEN</b>	Hunter Green	<b>506</b>
<b>COPPER</b>	Antique Copper	<b>506</b>
<b>15SPACE</b>	15" clearance top shelf in lieu of standard 12" clearance (add 3" to height of unit)	<b>\$147</b>
<b>HAL</b>	60 Watt Halogen Bulb in lieu of Standard Display Light	<b>each 69</b>

### ACCESSORIES (available for purchase at any time)

<b>GRSDS-DIV</b>	Additional Stainless Steel Divider Rods (Bottom shelf only)	<b>each \$30</b>
<b>GRSDH-DIV</b>	Additional Stainless Steel Divider Rods (Top shelf only)	<b>each 30</b>

### COLORS AND FINISHES – INSIDE BACK COVER

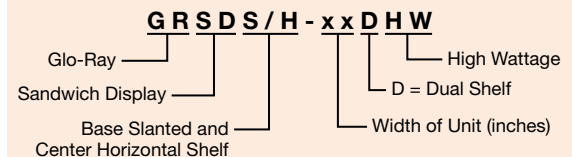

## Glo-Ray® Merchandising Warmers

Designed specifically for showcasing wrapped or boxed product, the Hatco Glo-Ray® Merchandising Warmers hold hot food safely at proper serving temperatures. These warmers offer the convenience of self-serve and the efficiency of kitchen-to-server holding.

- Available in single- or two-tier models (slant models available in three-tier)
- Product divider rods sort food displays
- Thermostatically-controlled hardcoated heated base, with a temperature range of 185°- 200°F, to extend holding times
- Horizontal or slant shelves
- Pre-focused infrared top heat directs heat to the outer edges where heat loss is greatest
- Shatter-resistant incandescent lights illuminate the holding areas and emphasize the product



GRSDS-30 with accessory 4" legs



GRSDH-30D



GRSDS-36T with optional Designer Black

Merchandisers

### HORIZONTAL MERCHANDISING WARMERS

Model	No. of Bulbs, Divider Rods	Dimensions (W x D x H) Height includes legs	Voltage	Usable Heated Shelf Space (W x D)	Watts	Plug	Approx. Ship Weight	List Price
<b>Single Shelf</b>								
GRSDH-24	2, 5	24" x 19½" x 12"	120	22¾" x 16½"	830	NEMA 5-15P	48 lbs.	<b>\$3363</b>
GRSDH-30	2, 6	30" x 19½" x 12"	120	28¾" x 16½"	970	NEMA 5-15P	56 lbs.	<b>3667</b>
GRSDH-36	2, 7	36" x 19½" x 12"	120	34¾" x 16½"	1170	NEMA 5-15P	66 lbs.	<b>3972</b>
GRSDH-41	3, 8	41" x 19½" x 15"	120	39¾" x 16½"	1340	NEMA 5-15P	74 lbs.	<b>4326</b>
GRSDH-52*	4, 10	52" x 19½" x 15"	120	50¾" x 16½"	1760	NEMA 5-15P	86 lbs.	<b>5050</b>
GRSDH-60	5, 12	60" x 19½" x 15"	120/208-240	58¾" x 16½"	2100	NEMA L14-20P	133 lbs.	<b>5689</b>
<b>Dual Shelf</b>								
GRSDH-24D*	4, 10	24" x 19½" x 25¾"	120	22¾" x 16½"	1660	NEMA 5-15P	88 lbs.	<b>\$5898</b>
GRSDH-30D†	4, 12	30" x 19½" x 25¾"	120	28¾" x 16½"	1920	NEMA 5-20P	100 lbs.	<b>6118</b>
GRSDH-36D↗	4, 14	36" x 19½" x 25¾"	120/208-240	34¾" x 16½"	2340	NEMA L14-20P	120 lbs.	<b>6477</b>
GRSDH-41D↗	6, 16	41" x 19½" x 25¾"	120/208-240	39¾" x 16½"	2680	NEMA L14-20P	137 lbs.	<b>6882</b>
GRSDH-52D↗	8, 20	52" x 19½" x 25¾"	120/208-240	50¾" x 16½"	3520	NEMA L14-20P	172 lbs.	<b>7929</b>
GRSDH-60D**‡	10, 24	60" x 19½" x 25¾"	120/208-240	58¾" x 16½"	4200	NEMA L14-20P	197 lbs.	<b>8740</b>

### SLANT MERCHANDISING WARMERS

Model	No. of Bulbs, Divider Rods	Dimensions (W x D x H) Height includes legs	Voltage	Usable Heated Shelf Space (W x D)	Watts	Plug	Approx. Ship Weight	List Price
<b>Single Shelf</b>								
GRSDS-24	2, 5	24" x 24¼" x 18½"	120	22½" x 21"	695	NEMA 5-15P	79 lbs.	<b>\$4045</b>
GRSDS-30	2, 6	30" x 24¼" x 18½"	120	28½" x 21"	790	NEMA 5-15P	80 lbs.	<b>4337</b>
GRSDS-36	2, 7	36" x 24¼" x 21½"	120	34½" x 21"	935	NEMA 5-15P	92 lbs.	<b>4672</b>
GRSDS-41	3, 8	41" x 24¼" x 21½"	120	39½" x 21"	1090	NEMA 5-15P	96 lbs.	<b>5014</b>
GRSDS-52	4, 10	52" x 24¼" x 21½"	120	50½" x 21"	1400	NEMA 5-15P	110 lbs.	<b>5754</b>
GRSDS-60*	5, 12	60" x 24¼" x 21½"	120	58½" x 21"	1715	NEMA 5-15P	167 lbs.	<b>6216</b>
<b>Dual Shelf</b>								
GRSDS-24D	4, 10	24" x 24¼" x 32¾"	120	22½" x 21"	1355	NEMA 5-15P	115 lbs.	<b>\$6323</b>
GRSDS-30D*	4, 12	30" x 24¼" x 32¾"	120	28½" x 21"	1530	NEMA 5-15P	140 lbs.	<b>6709</b>
GRSDS-36D	4, 14	36" x 24¼" x 32¾"	120	34½" x 21"	1810	NEMA 5-20P	160 lbs.	<b>7147</b>
GRSDS-41D↗	6, 16	41" x 24¼" x 32¾"	120/208-240	39½" x 21"	2120	NEMA L14-20P	180 lbs.	<b>7685</b>
GRSDS-52D↗	8, 20	52" x 24¼" x 32¾"	120/208-240	50½" x 21"	2725	NEMA L14-20P	215 lbs.	<b>8927</b>
GRSDS-60D	10, 24	60" x 24¼" x 32¾"	120/208-240	58½" x 21"	3340	NEMA L14-20P	238 lbs.	<b>9482</b>
<b>Triple Shelf</b>								
GRSDS-24T <sup>o</sup>	6, 15	23¾" x 24¼" x 43¾"	120	22½" x 21"	2015	NEMA 5-20P	164 lbs.	<b>\$8083</b>
GRSDS-36T	6, 21	35¾" x 24¼" x 43¾"	120/208-240	34½" x 21"	2685	NEMA L14-20P	219 lbs.	<b>8757</b>

\* Canadian models use NEMA 5-20P.

† For Canada only, external fuse box on top of unit, adds 3" to height.

↗ Requires 2, 120V power cords.

\*\* Canadian models uses NEMA L14-30P.

<sup>o</sup> Not available for Canada.

#### All Merchandising Warmer Models Feature:

Cord Location: Horizontal Models: Left rear corner toward server side.

Slant Models: Server side, bottom right corner.

#### OPTIONS AND ACCESSORIES – PAGE 167

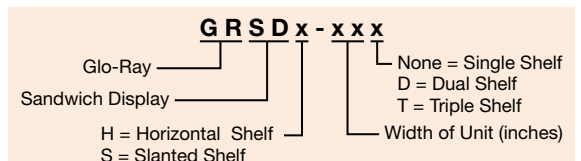



Two GRSDH-36D with dual horizontal shelves

Merchandisers

**OPTIONS** (available at time of purchase only)

<b>ITC-S</b>	Indicating Temperature Control (LED) for single shelf	<b>\$369</b>
<b>ITC-D</b>	Indicating Temperature Control (LED) for dual shelf	<b>636</b>
<b>SSEND</b>	Stainless Steel End Panels in lieu of Glass End Panels	<b>per shelf 51</b>
<b>5" Sneeze Guard (GRSDS one side, GRSDH two sides) –</b>		
<b>GRSD24BP</b>	24" wide models	<b>per shelf \$168</b>
<b>GRSD30BP</b>	30" wide models	<b>per shelf 200</b>
<b>GRSD36BP</b>	36" wide models	<b>per shelf 234</b>
<b>GRSD41BP</b>	41" wide models	<b>per shelf 268</b>
<b>GRSD52BP</b>	52" wide models	<b>per shelf 305</b>
<b>GRSD60BP</b>	60" wide models	<b>per shelf 431</b>
<b>HAL</b>	60 Watt Halogen Bulb in lieu of Standard Display Light	<b>each \$69</b>
<b>GRSDFLILOCK1</b>	Flip-Up Door Locking Plate (for GRSDS, GRSDS-xxD, and GRSDS-xxT 24" to 41" wide models)	<b>per shelf 22</b>
<b>GRSDFLILOCK2</b>	Flip-up Door Locking Plates (for GRSDS and GRSDS-xxD 52" to 60" wide models)	<b>per shelf 50</b>

**Display Sign Holder (Signs not included) – Color Matches Unit Color – Top or Intermediate Shelf (Slant or Horizontal models) –**

<b>GRSD-SIGN24</b>	24" width. Requires 22 $\frac{5}{8}$ "W x 3 $\frac{7}{8}$ "H x $\frac{1}{16}$ "D sign	<b>each \$154</b>
<b>GRSD-SIGN30</b>	30" width. Requires 28 $\frac{5}{8}$ "W x 3 $\frac{7}{8}$ "H x $\frac{1}{16}$ "D sign	<b>each 160</b>
<b>GRSD-SIGN36</b>	36" width. Requires 34 $\frac{5}{8}$ "W x 3 $\frac{7}{8}$ "H x $\frac{1}{16}$ "D sign	<b>each 167</b>
<b>GRSD-SIGN41</b>	41" width. Requires 39 $\frac{5}{8}$ "W x 3 $\frac{7}{8}$ "H x $\frac{1}{16}$ "D sign	<b>each 174</b>
<b>GRSD-SIGN52</b>	52" width. Requires 50 $\frac{5}{8}$ "W x 3 $\frac{7}{8}$ "H x $\frac{1}{16}$ "D sign	<b>each 188</b>
<b>GRSD-SIGN60</b>	60" width. Requires 58 $\frac{5}{8}$ "W x 3 $\frac{7}{8}$ "H x $\frac{1}{16}$ "D sign	<b>each 205</b>

**Plexi-Glass Flip-Up Doors on one side for GRSDS models – Not compatible with optional Sneeze Guards or Display Sign Holders in same opening –**

<b>SDS24FLIP</b>	24" wide models	<b>per shelf \$306</b>
<b>SDS30FLIP</b>	30" wide models	<b>per shelf 306</b>
<b>SDS36FLIP</b>	36" wide models	<b>per shelf 306</b>
<b>SDS41FLIP</b>	41" wide models	<b>per shelf 306</b>
<b>SDS52FLIP</b>	52" wide models	<b>per shelf 521</b>
<b>SDS60FLIP</b>	60" wide models	<b>per shelf 521</b>

**Plexi-Glass Flip-Up Doors on one side for GRSDH models – Not compatible with optional Sneeze Guards or Display Sign Holders in same opening –**

<b>GRSDH24FLIP</b>	24" wide models	<b>per shelf \$306</b>
<b>GRSDH30FLIP</b>	30" wide models	<b>per shelf 306</b>
<b>GRSDH36FLIP</b>	36" wide models	<b>per shelf 306</b>
<b>GRSDH41FLIP</b>	41" wide models	<b>per shelf 306</b>
<b>GRSDH52FLIP</b>	52" wide models	<b>per shelf 521</b>
<b>GRSDH60FLIP</b>	60" wide models	<b>per shelf 521</b>

**ACCESSORIES** (available for purchase at any time)

<b>4" LEGS</b>	4" Adjustable Legs (standard on units GRSDH-41 and larger, GRSDS-36 and larger and all duals)	<b>Set of 4 \$ 66</b>
<b>Chef LED 120V adjustable bulb – bulbs must be rotated down –</b>		
	<b>CLED-3000-120</b> Similar to warm Halogen light	
	<b>CLED-4000-120</b> Similar to cool Fluorescent light	<b>each 139</b>
<b>GRSDH-DIV</b>	Additional Stainless Steel Divider Rods – Horizontal model	<b>each \$30</b>
<b>GRSDS-DIV</b>	Additional Stainless Steel Divider Rods – Slant model	<b>each 30</b>

**OPTIONS** (available at time of purchase only)

**Designer Colors – Non-standard colors are non-returnable – Glossy Gray standard –**

<b>RED</b>	Warm Red	<b>\$506</b>
<b>BLACK</b>	Black	<b>506</b>
<b>GRAY</b>	Gray Granite	<b>506</b>
<b>WHITE</b>	White Granite	<b>506</b>
<b>NAVY</b>	Navy Blue	<b>506</b>
<b>GREEN</b>	Hunter Green	<b>506</b>
<b>COPPER</b>	Antique Copper	<b>506</b>

**COLORS AND FINISHES – INSIDE BACK COVER**

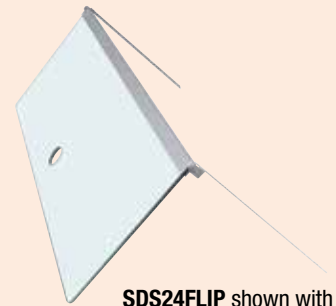

SDS24FLIP shown with brackets for retrofit



CLED-3000 and -4000 Accessory



## Glo-Ray® Designer Merchandising Warmers

Boost impulse sales by showcasing your hot foods in the Hatco Glo-Ray® Designer Merchandising Warmers. Designed specifically for displaying wrapped or boxed product, these warmers hold hot food safely at proper serving temperatures.

- Constructed of aluminum and stainless steel with tempered glass side panels
- Pre-focused infrared top heat directs heat to the outer edges where heat loss is greatest
- Convenient for self-serve or quick-serve areas
- Available in single- or two-tier models
- Horizontal or slant shelves
- Thermostatically-controlled hardcoated heated base extends holding times

- Product divider rods sort food displays
- Shatter-resistant incandescent lights illuminate the holding areas and emphasize the product



GR2SDH-30 with optional Designer Black inset panels and accessory flip-up plexi-glass door

**NOTE:** Designer Series width dimensions are 6¼" greater than the number listed in model.

Merchandisers

### DESIGNER HORIZONTAL DISPLAY WARMERS

Model <sup>®</sup>	No. of Bulbs, Divider Rods	Dimensions W x D x H (Height includes legs)	Voltage	Usable Heated Shelf Space (W x D)	Watts	Plug	Approx. Ship Weight	List Price
<b>Single Shelf</b>								
GR2SDH-24	2, 5	30¼" x 27" x 18½"	120	23⅞" x 22"	820	NEMA 5-15P	87 lbs.	<b>\$4467</b>
GR2SDH-30	2, 6	36¼" x 27" x 18½"	120	29⅞" x 22"	1020	NEMA 5-15P	120 lbs.	<b>4809</b>
GR2SDH-36	2, 7	42¼" x 27" x 18½"	120	35⅞" x 22"	1220	NEMA 5-15P	129 lbs.	<b>5160</b>
GR2SDH-42*	4, 8	48¼" x 27" x 18½"	120	41⅞" x 22"	1490	NEMA 5-15P	138 lbs.	<b>5723</b>
GR2SDH-48*	4, 9	54¼" x 27" x 18½"	120	47⅞" x 22"	1690	NEMA 5-15P	160 lbs.	<b>6290</b>
GR2SDH-54	4, 10	60¼" x 27" x 18½"	120	53⅞" x 22"	1890	NEMA 5-20P	172 lbs.	<b>6868</b>
GR2SDH-60	6, 12	66¼" x 27" x 18½"	120	59⅞" x 22"	2210	NEMA 5-30P	200 lbs.	<b>7396</b>
<b>Dual Shelf</b>								
GR2SDH-24D*	4, 10	30¼" x 27" x 29"	120	23⅞" x 22"	1640	NEMA 5-15P	126 lbs.	<b>\$ 7392</b>
GR2SDH-30D	4, 12	36¼" x 27" x 29"	120/208-240	29⅞" x 22"	2040	NEMA L14-20P	158 lbs.	<b>8820</b>
GR2SDH-36D	4, 14	42¼" x 27" x 29"	120/208-240	35⅞" x 22"	2440	NEMA L14-20P	205 lbs.	<b>8224</b>
GR2SDH-42D	8, 16	48¼" x 27" x 29"	120/208-240	41⅞" x 22"	2980	NEMA L14-20P	225 lbs.	<b>9006</b>
GR2SDH-48D	8, 18	54¼" x 27" x 29"	120/208-240	47⅞" x 22"	3380	NEMA L14-20P	254 lbs.	<b>9777</b>
GR2SDH-54D	8, 20	60¼" x 27" x 29"	120/208-240	53⅞" x 22"	3780	NEMA L14-20P	274 lbs.	<b>10572</b>
GR2SDH-60D	12, 24	66¼" x 27" x 29"	120/208-240	59⅞" x 22"	4420	NEMA L14-30P	328 lbs.	<b>11326</b>

### DESIGNER SLANT DISPLAY WARMERS

Model <sup>®</sup>	No. of Bulbs, Divider Rods	Dimensions W x D x H (Height includes legs)	Voltage	Usable Heated Shelf Space (W x D)	Watts	Plug	Approx. Ship Weight	List Price
<b>Single Shelf</b>								
GR2SDS-24	2, 5	30¼" x 26¾" x 22⅞"	120	23⅞" x 22"	820	NEMA 5-15P	102 lbs.	<b>\$4825</b>
GR2SDS-30	2, 6	36¼" x 26¾" x 22⅞"	120	29⅞" x 22"	1020	NEMA 5-15P	110 lbs.	<b>5093</b>
GR2SDS-36	2, 7	42¼" x 26¾" x 22⅞"	120	35⅞" x 22"	1220	NEMA 5-15P	136 lbs.	<b>5540</b>
GR2SDS-42*	4, 8	48¼" x 26¾" x 22⅞"	120	41⅞" x 22"	1490	NEMA 5-15P	155 lbs.	<b>6101</b>
GR2SDS-48*	4, 9	54¼" x 26¾" x 22⅞"	120	47⅞" x 22"	1690	NEMA 5-15P	164 lbs.	<b>6653</b>
GR2SDS-54	4, 10	60¼" x 26¾" x 22⅞"	120	53⅞" x 22"	1890	NEMA 5-20P	182 lbs.	<b>7217</b>
GR2SDS-60	6, 12	66¼" x 26¾" x 22⅞"	120	59⅞" x 22"	2210	NEMA 5-30P	202 lbs.	<b>7732</b>
<b>Dual Shelf</b>								
GR2SDS-24D*	4, 10	30¼" x 26¾" x 33⅞"	120	23⅞" x 22"	1640	NEMA 5-15P	160 lbs.	<b>\$ 7525</b>
GR2SDS-30D	4, 12	36¼" x 26¾" x 33⅞"	120/208-240	29⅞" x 22"	2040	NEMA L14-20P	184 lbs.	<b>8056</b>
GR2SDS-36D	4, 14	42¼" x 26¾" x 33⅞"	120/208-240	35⅞" x 22"	2440	NEMA L14-20P	200 lbs.	<b>8564</b>
GR2SDS-42D	8, 16	48¼" x 26¾" x 33⅞"	120/208-240	41⅞" x 22"	2980	NEMA L14-20P	218 lbs.	<b>9360</b>
GR2SDS-48D	8, 18	54¼" x 26¾" x 33⅞"	120/208-240	47⅞" x 22"	3380	NEMA L14-20P	255 lbs.	<b>10129</b>
GR2SDS-54D	8, 20	60¼" x 26¾" x 33⅞"	120/208-240	53⅞" x 22"	3780	NEMA L14-20P	265 lbs.	<b>10919</b>
GR2SDS-60D	12, 24	66¼" x 26¾" x 33⅞"	120/208-240	59⅞" x 22"	4420	NEMA L14-30P	296 lbs.	<b>11673</b>

<sup>®</sup> When no color is specified, color inset panels and corner caps will be Black.

\* Canadian models use NEMA 5-20P.

**All Designer Display Warmer Models Feature:**

Cord Location: Server side, bottom center.

### OPTIONS AND ACCESSORIES – PAGE 169

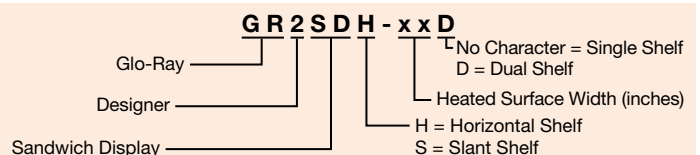





Merchandisers

**OPTIONS** (available at time of purchase only)

**Designer Corner Caps – Designer Black standard – DKGRAY** Dark Gray Corner Caps

No Charge

**5" Sneeze Guard – Customer side only on Slant models –**

<b>GR2SD24BP</b>	30 1/8" wide models	per shelf	<b>\$136</b>
<b>GR2SD30BP</b>	36 1/8" wide models	per shelf	<b>170</b>
<b>GR2SD36BP</b>	42 1/8" wide models	per shelf	<b>204</b>
<b>GR2SD42BP</b>	48 1/8" wide models	per shelf	<b>238</b>
<b>GR2SD48BP</b>	54 1/8" wide models	per shelf	<b>272</b>
<b>GR2SD54BP</b>	60 1/8" wide models	per shelf	<b>306</b>
<b>GR2SD60BP</b>	66 1/8" wide models	per shelf	<b>340</b>

**Plexi-Glass Flip-up Doors – on Control or Customer Side –**

<b>2SDS24FLIP</b>	30 1/8" wide models	per shelf	<b>\$228</b>
<b>2SDS30FLIP</b>	36 1/8" wide models	per shelf	<b>261</b>
<b>2SDS36FLIP</b>	42 1/8" wide models	per shelf	<b>297</b>
<b>2SDS42FLIP</b>	48 1/8" wide models	per shelf	<b>337</b>
<b>2SDS48FLIP</b>	54 1/8" wide models - split doors	per shelf	<b>395</b>
<b>2SDS54FLIP</b>	60 1/8" wide models - split doors	per shelf	<b>459</b>
<b>2SDS60FLIP</b>	66 1/8" wide models - split doors	per shelf	<b>527</b>

**2SDHFRGTGLS** Front Glass in lieu of Channel Dividers and Divider Rods. Cannot have Sneeze Guards or Flip-Up Doors (GR2SDH series, single models only) **\$124**

**2SDHFRGTGLS-D** Front Glass in lieu of Channel Dividers and Divider Rods. Cannot have Sneeze Guards or Flip-Up Doors (GR2SDH series, dual models only) **249**

**HAL** 60 Watt Halogen Bulb in lieu of Standard Display Light **each 69**

**SS-ITC** Indicating Temperature Control (LED) for single shelf (adds 1 7/8" to Horizontal model depth and 1 3/4" to Slant model depth) **369**

**DS-ITC** Indicating Temperature Control (LED) for dual shelf (adds 1 7/8" to Horizontal model depth and 1 3/4" to Slant model depth) **636**

**ACCESSORIES** (available for purchase at any time)

**2SD-DIV** Additional Stainless Steel Divider Rods **each \$ 30**

**Chef LED 120V adjustable bulb – bulbs must be rotated down –**

**CLED-3000-120** Similar to warm Halogen light **each 139**

**CLED-4000-120** Similar to cool Fluorescent light **each 139**

**COLORS AND FINISHES – INSIDE BACK COVER**

**CLED-3000 and -4000** Accessory



**OPTIONS**

(available at time of purchase only)

**Designer Colors –**

**Non-standard colors are non-returnable –**

**Clear Anodized Aluminum standard –**

<b>RED</b>	Warm Red	<b>\$506</b>
<b>BLACK</b>	Black	<b>506</b>
<b>GRAY</b>	Gray Granite	<b>506</b>
<b>WHITE</b>	White Granite	<b>506</b>
<b>NAVY</b>	Navy Blue	<b>506</b>
<b>GREEN</b>	Hunter Green	<b>506</b>
<b>COPPER</b>	Antique Copper	<b>506</b>

**Designer Inset Panel Colors –**

**Non-standard colors are non-returnable –**

**Black standard –**

<b>RED</b>	Warm Red	<b>No Charge</b>
<b>GRAY</b>	Gray Granite	<b>No Charge</b>
<b>WHITE</b>	White Granite	<b>No Charge</b>
<b>NAVY</b>	Navy Blue	<b>No Charge</b>
<b>GREEN</b>	Hunter Green	<b>No Charge</b>
<b>COPPER</b>	Antique Copper	<b>No Charge</b>



**SS-ITC** Optional



**DS-ITC** Optional

## Heated LED Merchandisers

The Heated Merchandiser with LED lighting is sleekly designed to safely hold hot packaged food to attract your grab-and-go customers. Available in slant or horizontal shelves, the Heated LED Merchandising Warmers are offered in both single and dual shelf models.

- Choose from slant or horizontal, single or dual shelf models
- Infrared heat safely holds hot packaged product for hours
- High efficiency LED lighting creates better illumination of food product in the holding area
- Feature a thermostatically-controlled hardcoated heated base shelf
- Hinged glass side panels are held in place magnetically and swing out for easy cleaning
- An optional Indicating Temperature Control (ITC) enhances accurate control of temperature



**HXMS-36D**  
in standard  
Designer Black

Merchandisers

### HORIZONTAL HEATED LED MERCHANDISING WARMERS

Model	Divider Rods	Dimensions (W x D x H) <i>Height includes legs</i>	Heated Shelf Space (W x D)	Voltage	Watts	Amps	Plug	Approx. Ship Weight	List Price
<b>Horizontal Single Shelf</b>									
HXMH-24	5	28" x 28 $\frac{1}{8}$ " x 21 $\frac{1}{8}$ "	22 $\frac{3}{8}$ " x 21 $\frac{3}{4}$ "	120	700	5.8	NEMA 5-15P	120 lbs.	<b>\$4997</b>
HXMH-30	6	34" x 28 $\frac{1}{8}$ " x 21 $\frac{1}{8}$ "	28 $\frac{3}{8}$ " x 21 $\frac{3}{4}$ "	120	900	7.5	NEMA 5-15P	133 lbs.	<b>5361</b>
HXMH-36	7	40" x 28 $\frac{1}{8}$ " x 21 $\frac{1}{8}$ "	34 $\frac{3}{8}$ " x 21 $\frac{3}{4}$ "	120	1100	9.2	NEMA 5-15P	145 lbs.	<b>5723</b>
HXMH-42	8	46" x 28 $\frac{1}{8}$ " x 21 $\frac{1}{8}$ "	40 $\frac{3}{8}$ " x 21 $\frac{3}{4}$ "	120	1200	10.0	NEMA 5-15P	161 lbs.	<b>6317</b>
HXMH-48	9	52" x 28 $\frac{1}{8}$ " x 21 $\frac{1}{8}$ "	46 $\frac{3}{8}$ " x 21 $\frac{3}{4}$ "	120	1450	12.1	NEMA 5-20P	190 lbs.	<b>6912</b>
HXMH-54	10	58" x 28 $\frac{1}{8}$ " x 21 $\frac{1}{8}$ "	52 $\frac{3}{8}$ " x 21 $\frac{3}{4}$ "	120	1650	13.8	NEMA 5-20P	200 lbs.	<b>7506</b>
HXMH-60	12	64" x 28 $\frac{1}{8}$ " x 21 $\frac{1}{8}$ "	58 $\frac{3}{8}$ " x 21 $\frac{3}{4}$ "	120	1850	15.4	NEMA 5-20P	206 lbs.	<b>8051</b>
<b>Horizontal Dual Shelf</b>									
HXMH-24D	10	28" x 28 $\frac{1}{8}$ " x 32 $\frac{3}{4}$ "	22 $\frac{3}{8}$ " x 21 $\frac{3}{4}$ "	120	1400	11.7	NEMA 5-15P	160 lbs.	<b>\$ 8141</b>
HXMH-30D	12	34" x 28 $\frac{1}{8}$ " x 32 $\frac{3}{4}$ "	28 $\frac{3}{8}$ " x 21 $\frac{3}{4}$ "	120/208-240	1800	7.5	NEMA L14-20P	185 lbs.	<b>8705</b>
HXMH-36D	14	40" x 28 $\frac{1}{8}$ " x 32 $\frac{3}{4}$ "	34 $\frac{3}{8}$ " x 21 $\frac{3}{4}$ "	120/208-240	2200	9.2	NEMA L14-20P	205 lbs.	<b>9105</b>
HXMH-42D	16	46" x 28 $\frac{1}{8}$ " x 32 $\frac{3}{4}$ "	40 $\frac{3}{8}$ " x 21 $\frac{3}{4}$ "	120/208-240	2400	10.0	NEMA L14-20P	220 lbs.	<b>9934</b>
HXMH-48D	18	52" x 28 $\frac{1}{8}$ " x 32 $\frac{3}{4}$ "	46 $\frac{3}{8}$ " x 21 $\frac{3}{4}$ "	120/208-240	2900	12.1	NEMA L14-20P	244 lbs.	<b>10740</b>
HXMH-54D	20	58" x 28 $\frac{1}{8}$ " x 32 $\frac{3}{4}$ "	52 $\frac{3}{8}$ " x 21 $\frac{3}{4}$ "	120/208-240	3300	13.8	NEMA L14-20P	271 lbs.	<b>11561</b>
HXMH-60D	24	64" x 28 $\frac{1}{8}$ " x 32 $\frac{3}{4}$ "	58 $\frac{3}{8}$ " x 21 $\frac{3}{4}$ "	120/208-240	3700	15.4	NEMA L14-20P	300 lbs.	<b>12319</b>

### SLANT HEATED LED MERCHANDISING WARMERS

Model	Divider Rods	Dimensions (W x D x H) <i>Height includes legs</i>	Heated Shelf Space (W x D)	Voltage	Watts	Amps	Plug	Approx. Ship Weight	List Price
<b>Slant Single Shelf</b>									
HXMS-24	5	28" x 28 $\frac{1}{8}$ " x 21 $\frac{3}{4}$ "	22 $\frac{3}{8}$ " x 21 $\frac{3}{4}$ "	120	700	5.8	NEMA 5-15P	112 lbs.	<b>\$5202</b>
HXMS-30	6	34" x 28 $\frac{1}{8}$ " x 21 $\frac{3}{4}$ "	28 $\frac{3}{8}$ " x 21 $\frac{3}{4}$ "	120	900	7.5	NEMA 5-15P	133 lbs.	<b>5490</b>
HXMS-36	7	40" x 28 $\frac{1}{8}$ " x 21 $\frac{3}{4}$ "	34 $\frac{3}{8}$ " x 21 $\frac{3}{4}$ "	120	1100	9.2	NEMA 5-15P	150 lbs.	<b>5972</b>
HXMS-42	8	46" x 28 $\frac{1}{8}$ " x 21 $\frac{3}{4}$ "	40 $\frac{3}{8}$ " x 21 $\frac{3}{4}$ "	120	1200	10.0	NEMA 5-15P	161 lbs.	<b>6571</b>
HXMS-48	9	52" x 28 $\frac{1}{8}$ " x 21 $\frac{3}{4}$ "	46 $\frac{3}{8}$ " x 21 $\frac{3}{4}$ "	120	1450	12.1	NEMA 5-20P	188 lbs.	<b>7169</b>
HXMS-54	10	58" x 28 $\frac{1}{8}$ " x 21 $\frac{3}{4}$ "	52 $\frac{3}{8}$ " x 21 $\frac{3}{4}$ "	120	1650	13.8	NEMA 5-20P	205 lbs.	<b>7777</b>
HXMS-60	12	64" x 28 $\frac{1}{8}$ " x 21 $\frac{3}{4}$ "	58 $\frac{3}{8}$ " x 21 $\frac{3}{4}$ "	120	1850	15.4	NEMA 5-20P	205 lbs.	<b>8335</b>
<b>Slant Dual Shelf</b>									
HXMS-24D	10	28" x 28 $\frac{1}{8}$ " x 32 $\frac{3}{4}$ "	22 $\frac{3}{8}$ " x 21 $\frac{3}{4}$ "	120	1400	11.7	NEMA 5-15P	160 lbs.	<b>\$ 8141</b>
HXMS-30D	12	34" x 28 $\frac{1}{8}$ " x 32 $\frac{3}{4}$ "	28 $\frac{3}{8}$ " x 21 $\frac{3}{4}$ "	120/208-240	1800	7.5	NEMA L14-20P	187 lbs.	<b>8705</b>
HXMS-36D	14	40" x 28 $\frac{1}{8}$ " x 32 $\frac{3}{4}$ "	34 $\frac{3}{8}$ " x 21 $\frac{3}{4}$ "	120/208-240	2200	9.2	NEMA L14-20P	208 lbs.	<b>9227</b>
HXMS-42D	16	46" x 28 $\frac{1}{8}$ " x 32 $\frac{3}{4}$ "	40 $\frac{3}{8}$ " x 21 $\frac{3}{4}$ "	120/208-240	2400	10.0	NEMA L14-20P	232 lbs.	<b>10080</b>
HXMS-48D	18	52" x 28 $\frac{1}{8}$ " x 32 $\frac{3}{4}$ "	46 $\frac{3}{8}$ " x 21 $\frac{3}{4}$ "	120/208-240	2900	12.1	NEMA L14-20P	245 lbs.	<b>10918</b>
HXMS-54D	20	58" x 28 $\frac{1}{8}$ " x 32 $\frac{3}{4}$ "	52 $\frac{3}{8}$ " x 21 $\frac{3}{4}$ "	120/208-240	3300	13.8	NEMA L14-20P	270 lbs.	<b>11768</b>
HXMS-60D	24	64" x 28 $\frac{1}{8}$ " x 32 $\frac{3}{4}$ "	58 $\frac{3}{8}$ " x 21 $\frac{3}{4}$ "	120/208-240	3700	15.4	NEMA L14-20P	291 lbs.	<b>12577</b>

**All Heated LED Merchandising Warmer Models Feature:**  
Cord Location: Server side, bottom center on left side of control box.

### OPTIONS AND ACCESSORIES – PAGE 172

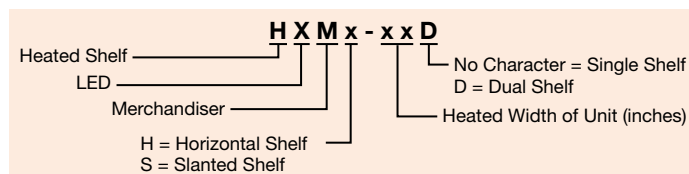

## Heated Zone Merchandisers

The energy-efficient Hatco Heated Zone Merchandiser safely holds hot packaged food in eye catching design to draw in your customers, while LED lighting showcases your food product. Hatco's Spot-On® Technology will reduce your energy consumption while keeping your foods at the desired temperature.

- Spot-On technology turns overhead heat on only when product is present in that zone, while base heat goes from energy saving mode to the temperature you set
- Our fast action ribbon elements will be up to temperature in less than 10 seconds
- Choose from slant or horizontal shelves, single or dual shelf models, and in 2 to 12 zones depending on the model size
- LCD display scans and displays the various zone settings

- Hinged glass side panels swing out for easy cleaning
- Channel dividers are held in place by magnets, giving the unit more heated surface



HZMH-24 in standard Designer Black



Merchandisers

### HORIZONTAL HEATED ZONE MERCHANDISING WARMERS

Model	Zones per Shelf	Divider Rods	Dimensions (W x D x H) <i>Height includes legs</i>	Usable Heated Surface per Zone (W x D)	Voltage Single Phase	Watts	Plug	Approx. Ship Weight	List Price
<b>Horizontal Single Shelf</b>									
HZMH-24	2	3	28" x 28 <sup>5</sup> / <sub>8</sub> " x 21 <sup>3</sup> / <sub>4</sub> "	20" x 21 <sup>3</sup> / <sub>4</sub> "	120	750	NEMA 5-15P	125 lbs	\$ 6492
HZMH-30	4	4	34" x 28 <sup>5</sup> / <sub>8</sub> " x 21 <sup>3</sup> / <sub>4</sub> "	12 <sup>3</sup> / <sub>8</sub> " x 21 <sup>3</sup> / <sub>4</sub> "	120	1350	NEMA 5-15P	141 lbs	6950
HZMH-36	4	4	40" x 28 <sup>5</sup> / <sub>8</sub> " x 21 <sup>3</sup> / <sub>4</sub> "	15 <sup>5</sup> / <sub>8</sub> " x 21 <sup>3</sup> / <sub>4</sub> "	120	1400	NEMA 5-15P	159 lbs	7415
HZMH-42	4	6	46" x 28 <sup>5</sup> / <sub>8</sub> " x 21 <sup>3</sup> / <sub>4</sub> "	18 <sup>3</sup> / <sub>8</sub> " x 21 <sup>3</sup> / <sub>4</sub> "	120	1450	NEMA 5-20P	172 lbs	8171
HZMH-48	4	6	52" x 28 <sup>5</sup> / <sub>8</sub> " x 21 <sup>3</sup> / <sub>4</sub> "	21 <sup>3</sup> / <sub>8</sub> " x 21 <sup>3</sup> / <sub>4</sub> "	120	1500	NEMA 5-20P	182 lbs	8921
HZMH-54	6	6	58" x 28 <sup>5</sup> / <sub>8</sub> " x 21 <sup>3</sup> / <sub>4</sub> "	15 <sup>1</sup> / <sub>16</sub> " x 21 <sup>3</sup> / <sub>4</sub> "	120	2100	NEMA 5-30P	202 lbs	9684
HZMH-60	6	9	64" x 28 <sup>5</sup> / <sub>8</sub> " x 21 <sup>3</sup> / <sub>4</sub> "	17 <sup>1</sup> / <sub>16</sub> " x 21 <sup>3</sup> / <sub>4</sub> "	120	2150	NEMA 5-30P	216 lbs	10397
<b>Horizontal Dual Shelf</b>									
HZMH-24D	2	6	28" x 28 <sup>5</sup> / <sub>8</sub> " x 32 <sup>3</sup> / <sub>8</sub> "	20" x 21 <sup>3</sup> / <sub>4</sub> "	120	1500	NEMA 5-20P	176 lbs	\$10783
HZMH-30D	4	8	34" x 28 <sup>5</sup> / <sub>8</sub> " x 32 <sup>3</sup> / <sub>8</sub> "	12 <sup>3</sup> / <sub>8</sub> " x 21 <sup>3</sup> / <sub>4</sub> "	120/208-240	2700	NEMA L14-20P	204 lbs	11350
HZMH-36D	4	8	40" x 28 <sup>5</sup> / <sub>8</sub> " x 32 <sup>3</sup> / <sub>8</sub> "	15 <sup>5</sup> / <sub>8</sub> " x 21 <sup>3</sup> / <sub>4</sub> "	120/208-240	2800	NEMA L14-20P	228 lbs	11875
HZMH-42D	4	12	46" x 28 <sup>5</sup> / <sub>8</sub> " x 32 <sup>3</sup> / <sub>8</sub> "	18 <sup>3</sup> / <sub>8</sub> " x 21 <sup>3</sup> / <sub>4</sub> "	120/208-240	2900	NEMA L14-20P	246 lbs	13341
HZMH-48D	4	12	52" x 28 <sup>5</sup> / <sub>8</sub> " x 32 <sup>3</sup> / <sub>8</sub> "	21 <sup>3</sup> / <sub>8</sub> " x 21 <sup>3</sup> / <sub>4</sub> "	120/208-240	3000	NEMA L14-20P	265 lbs	13972
HZMH-54D	6	12	58" x 28 <sup>5</sup> / <sub>8</sub> " x 32 <sup>3</sup> / <sub>8</sub> "	15 <sup>1</sup> / <sub>16</sub> " x 21 <sup>3</sup> / <sub>4</sub> "	120/208-240	4200	NEMA L14-30P	308 lbs	15017
HZMH-60D	6	18	64" x 28 <sup>5</sup> / <sub>8</sub> " x 32 <sup>3</sup> / <sub>8</sub> "	17 <sup>1</sup> / <sub>16</sub> " x 21 <sup>3</sup> / <sub>4</sub> "	120/208-240	4300	NEMA L14-30P	331 lbs	16028

### SLANT HEATED ZONE MERCHANDISING WARMERS

Model	Zones per Shelf	Divider Rods	Dimensions (W x D x H) <i>Height includes legs</i>	Usable Heated Surface per Zone (W x D)	Voltage Single Phase	Watts	Plug	Approx. Ship Weight	List Price
<b>Slant Single Shelf</b>									
HZMS-24	2	3	28" x 28 <sup>1</sup> / <sub>8</sub> " x 21 <sup>3</sup> / <sub>4</sub> "	20" x 21 <sup>3</sup> / <sub>4</sub> "	120	750	NEMA 5-15P	120 lbs	\$ 7032
HZMS-30	4	4	34" x 28 <sup>1</sup> / <sub>8</sub> " x 21 <sup>3</sup> / <sub>4</sub> "	12 <sup>3</sup> / <sub>8</sub> " x 21 <sup>3</sup> / <sub>4</sub> "	120	1350	NEMA 5-15P	145 lbs	7393
HZMS-36	4	4	40" x 28 <sup>1</sup> / <sub>8</sub> " x 21 <sup>3</sup> / <sub>4</sub> "	15 <sup>5</sup> / <sub>8</sub> " x 21 <sup>3</sup> / <sub>4</sub> "	120	1400	NEMA 5-15P	159 lbs	7995
HZMS-42	4	6	46" x 28 <sup>1</sup> / <sub>8</sub> " x 21 <sup>3</sup> / <sub>4</sub> "	18 <sup>3</sup> / <sub>8</sub> " x 21 <sup>3</sup> / <sub>4</sub> "	120	1450	NEMA 5-20P	172 lbs	8745
HZMS-48	4	6	52" x 28 <sup>1</sup> / <sub>8</sub> " x 21 <sup>3</sup> / <sub>4</sub> "	21 <sup>3</sup> / <sub>8</sub> " x 21 <sup>3</sup> / <sub>4</sub> "	120	1500	NEMA 5-20P	187 lbs	9484
HZMS-54	6	6	58" x 28 <sup>1</sup> / <sub>8</sub> " x 21 <sup>3</sup> / <sub>4</sub> "	15 <sup>1</sup> / <sub>16</sub> " x 21 <sup>3</sup> / <sub>4</sub> "	120	2100	NEMA 5-30P	202 lbs	10244
HZMS-60	6	9	64" x 28 <sup>1</sup> / <sub>8</sub> " x 21 <sup>3</sup> / <sub>4</sub> "	17 <sup>1</sup> / <sub>16</sub> " x 21 <sup>3</sup> / <sub>4</sub> "	120	2150	NEMA 5-30P	216 lbs	10935
<b>Slant Dual Shelf</b>									
HZMS-24D	2	6	28" x 28 <sup>1</sup> / <sub>8</sub> " x 32 <sup>3</sup> / <sub>4</sub> "	20" x 21 <sup>3</sup> / <sub>4</sub> "	120	1500	NEMA 5-20P	176 lbs	\$11046
HZMS-30D	4	8	34" x 28 <sup>1</sup> / <sub>8</sub> " x 32 <sup>3</sup> / <sub>4</sub> "	12 <sup>3</sup> / <sub>8</sub> " x 21 <sup>3</sup> / <sub>4</sub> "	120/208-240	2700	NEMA L14-20P	209 lbs	11766
HZMS-36D	4	8	40" x 28 <sup>1</sup> / <sub>8</sub> " x 32 <sup>3</sup> / <sub>4</sub> "	15 <sup>5</sup> / <sub>8</sub> " x 21 <sup>3</sup> / <sub>4</sub> "	120/208-240	2800	NEMA L14-20P	223 lbs	12453
HZMS-42D	4	12	46" x 28 <sup>1</sup> / <sub>8</sub> " x 32 <sup>3</sup> / <sub>4</sub> "	18 <sup>3</sup> / <sub>8</sub> " x 21 <sup>3</sup> / <sub>4</sub> "	120/208-240	2900	NEMA L14-20P	248 lbs	13519
HZMS-48D	4	12	52" x 28 <sup>1</sup> / <sub>8</sub> " x 32 <sup>3</sup> / <sub>4</sub> "	21 <sup>3</sup> / <sub>8</sub> " x 21 <sup>3</sup> / <sub>4</sub> "	120/208-240	3000	NEMA L14-20P	263 lbs	14625
HZMS-54D	6	12	58" x 28 <sup>1</sup> / <sub>8</sub> " x 32 <sup>3</sup> / <sub>4</sub> "	15 <sup>1</sup> / <sub>16</sub> " x 21 <sup>3</sup> / <sub>4</sub> "	120/208-240	4200	NEMA L14-30P	298 lbs	15621
HZMS-60D	6	18	64" x 28 <sup>1</sup> / <sub>8</sub> " x 32 <sup>3</sup> / <sub>4</sub> "	17 <sup>1</sup> / <sub>16</sub> " x 21 <sup>3</sup> / <sub>4</sub> "	120/208-240	4300	NEMA L14-30P	332 lbs	16631

All Heated Zone Merchandising Warmer Models Feature:

Cord Location: Server side, bottom center on left side of control box.

### OPTIONS AND ACCESSORIES – PAGE 172

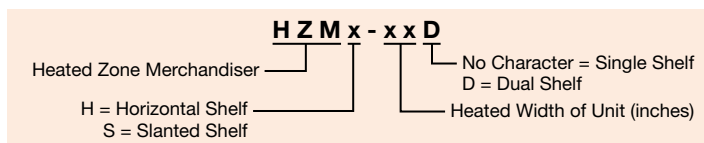





HZMS-48D in standard *Designer Black* with optional LED accent lighting in support posts

**OPTIONS** (available at time of purchase only)

**Designer Colors – Non-standard colors are non-returnable – Black standard –**

<b>RED</b>	Warm Red	<b>\$506</b>
<b>GRAY</b>	Gray Granite	<b>506</b>
<b>WHITE</b>	White Granite	<b>506</b>
<b>NAVY</b>	Navy Blue	<b>506</b>
<b>GREEN</b>	Hunter Green	<b>506</b>
<b>COPPER</b>	Antique Copper	<b>506</b>

<b>HZM-LP</b>	Red LED Accent Lighting in support post (HXM and HZM models)	<b>\$770</b>
---------------	--	--------------

**Wire Guards – Single shelf, Slant and Horizontal models – HZM models only –**

<b>HZMWG-24</b>	Wire Guard on -24 models	<b>\$ 94</b>
<b>HZMWG-30 -36 -42 -48</b>	Wire Guard on -30, -36, -42 or -48 models	<b>188</b>
<b>HZMWG-54 -60</b>	Wire Guard on -54 or -60 models	<b>282</b>

**Wire Guards – Dual shelf, Slant and Horizontal models – HZM models only –**

<b>HZMWG-24D</b>	Wire Guard on -24D Models	<b>\$188</b>
<b>HZMWG-30D -36D -42D -48D</b>	Wire Guard on -30D, -36D, -42D or -48D Models	<b>376</b>
<b>HZMWG-54D -60D</b>	Wire Guard on -54D or -60D Models	<b>564</b>

<b>SS-ITC</b>	Indicating Temperature Control (LED) for single shelf (for HXM models only)	<b>\$369</b>
---------------	---	--------------

<b>DS-ITC</b>	Indicating Temperature Control (LED) for dual shelf (for HXM models only)	<b>636</b>
---------------	---	------------

**Sneeze Guards – HXM and HZM models – Not compatible with Flip-Up Doors in same opening –**

<b>HZM24BP</b>	5" Sneeze Guard on Customer Side on -24 models	<b>per shelf \$283</b>
<b>HZM30BP</b>	5" Sneeze Guard on Customer Side on -30 models	<b>per shelf 308</b>
<b>HZM36BP</b>	5" Sneeze Guard on Customer Side on -36 models	<b>per shelf 333</b>
<b>HZM42BP</b>	5" Sneeze Guard on Customer Side on -42 models	<b>per shelf 367</b>
<b>HZM48BP</b>	5" Sneeze Guard on Customer Side on -48 models	<b>per shelf 400</b>
<b>HZM54BP</b>	5" Sneeze Guard on Customer Side on -54 models	<b>per shelf 436</b>
<b>HZM60BP</b>	5" Sneeze Guard on Customer Side on -60 models	<b>per shelf 471</b>

**Flip-Up Doors – HXM and HZM models – Not compatible with Sneeze Guards in same opening, one side only –**

<b>HZM24FLIP</b>	Plexi-Glass Flip-up Doors on Control or Customer side on -24 models	<b>per shelf \$284</b>
<b>HZM30FLIP</b>	Plexi-Glass Flip-up Doors on Control or Customer side on -30 models	<b>per shelf 308</b>
<b>HZM36FLIP</b>	Plexi-Glass Flip-up Doors on Control or Customer side on -36 models	<b>per shelf 336</b>
<b>HZM42FLIP</b>	Plexi-Glass Flip-up Doors on Control or Customer side on -42 models	<b>per shelf 366</b>
<b>HZM48FLIP</b>	Plexi-Glass Flip-up Doors on Control or Customer side on -48 models	<b>per shelf 398</b>
<b>HZM54FLIP</b>	Plexi-Glass Flip-up Doors on Control or Customer side on -54 models	<b>per shelf 436</b>
<b>HZM60FLIP</b>	Plexi-Glass Flip-up Doors on Control or Customer side on -60 models	<b>per shelf 475</b>

**ACCESSORIES** (available for purchase at any time)

<b>HZM-DIV</b>	Additional Stainless Steel Divider Rods (HXM and HZM models)	<b>each \$32</b>
----------------	--	------------------

**COLORS AND FINISHES – INSIDE BACK COVER**



## Glo-Ray® Heated Glass Merchandisers

Hatco's patented heated glass shelves provide maximum product visibility while increasing product capacity. All models are available in *Designer* colors or stainless steel, with tempered glass end panels, a thermostatically-controlled heated base, product divider rods and 2½" legs.

- The heated glass shelves make these self-serve merchandisers uniquely visual
- Patented heated glass shelf provides an even heat source for top and bottom heat to safely hold product
- Thermostatically-controlled, hardcoated heated base
- Standard 2½" adjustable legs (adds 2¾" to height of unit)
- Available in horizontal or slanted versions to meet your needs or style
- *Designer* color models, posts, base panels and sign holder for top and middle shelves optional. Non-standard colors are non-returnable
- Flip-up doors and 4" legs available
- LED lights showcase food product and saves energy and money
- Modular design accommodates side-by-side expansion



**GR3SDH-39**  
in optional  
Stainless Steel finish



**GR3SDS-39D**  
in optional  
*Designer* Navy Blue

Merchandisers

### HORIZONTAL DISPLAY WARMERS WITH HEATED GLASS

Model	No. of Rods	Dimensions W x D x H †	Usable Heated Shelf Space (W x D)	Voltage	Watts	Plug	Approx. Ship Weight	List Price
<b>Single Shelf</b>								
GR3SDH-27	10	27¼" x 27¼" x 13¾"	22 <sup>16</sup> / <sub>25</sub> " x 20 <sup>16</sup> / <sub>25</sub> "	120	997	NEMA 5-15P	108 lbs.	<b>\$5152</b>
GR3SDH-33	12	33¼" x 27¼" x 13¾"	28 <sup>16</sup> / <sub>25</sub> " x 20 <sup>16</sup> / <sub>25</sub> "	120	1251	NEMA 5-15P	120 lbs.	<b>5554</b>
GR3SDH-39*	14	39¼" x 27¼" x 13¾"	34 <sup>16</sup> / <sub>25</sub> " x 20 <sup>16</sup> / <sub>25</sub> "	120	1505	NEMA 5-15P	133 lbs.	<b>5968</b>
<b>Dual Shelf</b>								
GR3SDH-27D*	15	27¼" x 27¼" x 23½"	22 <sup>16</sup> / <sub>25</sub> " x 20 <sup>16</sup> / <sub>25</sub> "	120	1769	NEMA 5-15P	147 lbs.	<b>\$8544</b>
GR3SDH-33D	18	33¼" x 27¼" x 23½"	28 <sup>16</sup> / <sub>25</sub> " x 20 <sup>16</sup> / <sub>25</sub> "	120/208-240	2227	NEMA L14-20P	166 lbs.	<b>9029</b>
GR3SDH-39D	21	39¼" x 27¼" x 23½"	34 <sup>16</sup> / <sub>25</sub> " x 20 <sup>16</sup> / <sub>25</sub> "	120/208-240	2685	NEMA L14-20P	194 lbs.	<b>9489</b>

### SLANT DISPLAY WARMERS WITH HEATED GLASS

Model	No. of Rods	Dimensions W x D x H †	Usable Heated Shelf Space (W x D)	Voltage	Watts	Plug	Approx. Ship Weight	List Price
<b>Single Shelf</b>								
GR3SDS-27	10	27¼" x 26 <sup>7</sup> / <sub>8</sub> " x 18 <sup>1</sup> / <sub>8</sub> "	22 <sup>16</sup> / <sub>25</sub> " x 20 <sup>16</sup> / <sub>25</sub> "	120	997	NEMA 5-15P	115 lbs.	<b>\$5564</b>
GR3SDS-33	12	33¼" x 26 <sup>7</sup> / <sub>8</sub> " x 18 <sup>1</sup> / <sub>8</sub> "	28 <sup>16</sup> / <sub>25</sub> " x 20 <sup>16</sup> / <sub>25</sub> "	120	1251	NEMA 5-15P	127 lbs.	<b>5882</b>
GR3SDS-39	14	39¼" x 26 <sup>7</sup> / <sub>8</sub> " x 18 <sup>1</sup> / <sub>8</sub> "	34 <sup>16</sup> / <sub>25</sub> " x 20 <sup>16</sup> / <sub>25</sub> "	120	1505	NEMA 5-15P	156 lbs.	<b>6394</b>
<b>Dual Shelf</b>								
GR3SDS-27D	15	27¼" x 26 <sup>7</sup> / <sub>8</sub> " x 28 <sup>1</sup> / <sub>8</sub> "	22 <sup>16</sup> / <sub>25</sub> " x 20 <sup>16</sup> / <sub>25</sub> "	120	1769	NEMA 5-15P	164 lbs.	<b>\$8670</b>
GR3SDS-33D	18	33¼" x 26 <sup>7</sup> / <sub>8</sub> " x 28 <sup>1</sup> / <sub>8</sub> "	28 <sup>16</sup> / <sub>25</sub> " x 20 <sup>16</sup> / <sub>25</sub> "	120/208-240	2227	NEMA L14-20P	190 lbs.	<b>9282</b>
GR3SDS-39D	21	39¼" x 26 <sup>7</sup> / <sub>8</sub> " x 28 <sup>1</sup> / <sub>8</sub> "	34 <sup>16</sup> / <sub>25</sub> " x 20 <sup>16</sup> / <sub>25</sub> "	120/208-240	2685	NEMA L14-20P	206 lbs.	<b>9869</b>

† Height does not include 2¾" legs.  
\* Canadian models use NEMA 5-20P.

**All Heated Glass Display Warmer Models Feature:**  
Cord Location: Server side, bottom right corner.

### OPTIONS AND ACCESSORIES – PAGE 174

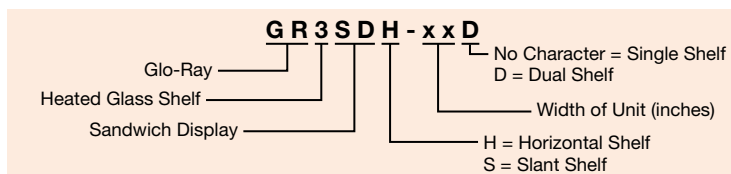



**GR3SDS-39D** in optional  
*Designer Antique Copper*

### OPTIONS *(available at time of purchase only)*

**Designer Colors – Non-standard colors are non-returnable – Black standard –**

<b>RED</b>	Warm Red	<b>No Charge</b>
<b>GRAY</b>	Gray Granite	<b>No Charge</b>
<b>WHITE</b>	White Granite	<b>No Charge</b>
<b>NAVY</b>	Navy Blue	<b>No Charge</b>
<b>GREEN</b>	Hunter Green	<b>No Charge</b>
<b>COPPER</b>	Antique Copper	<b>No Charge</b>
<b>GR3-SS</b>	Stainless Steel Body and Base (unpainted posts)	<b>\$292</b>
<b>GR3SD27BP</b>	5" Sneeze Guard on Customer side on 27 $\frac{1}{4}$ " wide models	<b>per shelf 239</b>
<b>GR3SD33BP</b>	5" Sneeze Guard on Customer side on 33 $\frac{1}{4}$ " wide models	<b>per shelf 252</b>
<b>GR3SD39BP</b>	5" Sneeze Guard on Customer side on 39 $\frac{1}{4}$ " wide models	<b>per shelf 268</b>
<b>3SD27FLIP</b>	Plexi-Glass Flip-Up Doors on front or back on 27 $\frac{1}{4}$ " wide models	<b>per shelf 178</b>
<b>3SD33FLIP</b>	Plexi-Glass Flip-Up Doors on front or back on 33 $\frac{1}{4}$ " wide models	<b>per shelf 218</b>
<b>3SD39FLIP</b>	Plexi-Glass Flip-Up Doors on front or back on 39 $\frac{1}{4}$ " wide models	<b>per shelf 260</b>
<b>3SDEND</b>	Plexi-Glass End Panels in lieu of Glass End Panels	<b>per shelf 26</b>

**Painted Shelf Sign Holder (Signs not included) – Color matches unit color – Top or Intermediate Shelf – (Slant or Horizontal models) –**

<b>3SD27SIGN</b>	27" width model. Requires 27"W x 2 $\frac{1}{16}$ "H x $\frac{1}{16}$ "D Sign	<b>each \$107</b>
<b>3SD33SIGN</b>	33" width model. Requires 33"W x 2 $\frac{1}{16}$ "H x $\frac{1}{16}$ "D Sign	<b>each 115</b>
<b>3SD39SIGN</b>	39" width model. Requires 39"W x 2 $\frac{1}{16}$ "H x $\frac{1}{16}$ "D Sign	<b>each 123</b>

### ACCESSORIES *(available for purchase at any time)*

<b>4" LEGS</b>	4" Adjustable Legs	<b>Set of 4 \$66</b>
<b>3SD-DIV</b>	Additional Stainless Steel Divider Rods	<b>each 30</b>

### COLORS AND FINISHES – INSIDE BACK COVER

## Glo-Ray® Heated Glass Merchandisers

Glo-Ray® Heated Glass Merchandising Warmers are perfect for self-serve operations, designed specifically to hold hot wrapped or boxed product at optimum serving temperatures. Increasing holding capacities and impulse sales with a beautiful curved design that compliments any décor.

- Unique, patented heated glass shelves with infinite controls conduct heat to food product above and below
- Blanket-style heating elements in the hardcoated base and canopy are thermostatically-controlled
- LED lighting allows for optimum food product display with energy saving
- Attractive curved top design includes a built-in top sign holder for your own custom signage, 26.75" W (679 mm) x 3" H (76 mm), at the top front of the unit
- Also comes with: tempered glass side panels, 2.5" legs, thermostatically-controlled heated base and upper canopy, divider rods and comes standard in *Designer Black*



GR3SDS-27TCT in optional *Designer Glossy Gray* and top sign holder (Sign not included)



GR3SDS-39DCT in standard *Designer Black* and top sign holder

Merchandisers

### SLANT DISPLAY WARMERS WITH HEATED GLASS

Model	No. of Rods	Dimensions W x D x H †	Usable Heated Shelf Space (W x D)	Voltage	Watts	Plug	Approx. Ship Weight	List Price
<b>Dual Shelf</b>								
GR3SDS-27DCT	10	27¼" x 27⅞" x 26⅜"	22⅞" x 20⅞"	120	1340	NEMA 5-15P	155 lbs.	<b>\$ 8055</b>
GR3SDS-33DCT	12	33¼" x 27⅞" x 26⅜"	28⅞" x 20⅞"	120	1747	NEMA 5-15P*	175 lbs.	<b>9032</b>
GR3SDS-39DCT	14	39¼" x 27½" x 26½"	34⅞" x 20⅞"	120/208-240	2130	NEMA 5-15P	186 lbs.	<b>10141</b>
<b>Triple Shelf</b>								
GR3SDS-27TCT	15	27¼" x 29" x 34⅞"	22⅞" x 20⅞"	120/208-240	2095	NEMA L14-20P	190 lbs.	<b>\$10364</b>
GR3SDS-33TCT	18	33¼" x 28" x 34⅞"	28⅞" x 20⅞"	120/208-240	2723	NEMA L14-20P	215 lbs.	<b>12005</b>
GR3SDS-39TCT	21	39¼" x 27½" x 34⅞"	34⅞" x 20⅞"	120/208-240	3310	NEMA L14-20P	230 lbs.	<b>13316</b>

† Height includes 2.5" legs.

\* Canadian models use NEMA 5-20P.

**All Heated Glass Merchandiser Models Feature:**

**Cord Location:** Server side, bottom right corner.

### OPTIONS (available at time of purchase only)

<b>Designer Colors – Non-standard colors are non-returnable – Black standard –</b>		
<b>RED</b>	Warm Red	<b>\$506</b>
<b>GRAY</b>	Gray Granite	<b>506</b>
<b>WHITE</b>	White Granite	<b>506</b>
<b>NAVY</b>	Navy Blue	<b>506</b>
<b>GREEN</b>	Hunter Green	<b>506</b>
<b>COPPER</b>	Antique Copper	<b>506</b>
<b>Gloss Finish – Non-standard colors are non-returnable – Black standard –</b>		
<b>GGRAY</b>	Glossy Gray	<b>\$506</b>

### ACCESSORIES (available for purchase at any time)

<b>4" LEGS</b>	4" Adjustable Legs	<b>Set of 4 \$66</b>
<b>3SD-DIV</b>	Additional Stainless Steel Divider Rods	<b>each 30</b>

### COLORS AND FINISHES – INSIDE BACK COVER

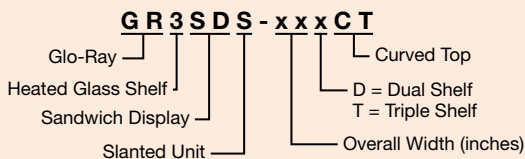

## Glo-Ray® Curved Merchandising Warmers

Looking to add a touch of class to a new point-of-sale area or to change or upgrade an existing area? Hatco's Glo-Ray® Curved Merchandising Warmer offers a unique and attractive solution for impulse sales areas.

- Single shelf and dual shelf units come standard with mirrored glass back panel
- Individual thermostatically-controlled heated base with master rocker switch maintains safe serving temperatures
- Halogen lighting allows for optimal food product display

- Humidified dual shelf unit contains a five cup capacity water reservoir
- Models with Simulated Stone are Swanstone®



**GRCMW-1** in standard *Designer Black* with food pans (not available)



**GRCMW-1DH** in standard *Designer Black* with food pans (not available)

Merchandisers

### CURVED MERCHANDISING WARMERS

Model	Dimensions W x D x H	Voltage Single Phase	Usable Heated Surface Space (W x D)		Watts	Plug	Approx. Ship Weight	List Price
			Top Shelf	Bottom Shelf				
<b>Single Shelf</b>								
<b>GRCMW-1</b>	22 $\frac{1}{2}$ " x 21 $\frac{1}{2}$ " x 19 $\frac{7}{8}$ "	120	—	19 $\frac{3}{4}$ " x 13"	670	NEMA 5-15P	56 lbs.	<b>\$3805</b>
<b>Dual Shelf</b>								
<b>GRCMW-1D*</b>	26" x 20 $\frac{1}{8}$ " x 26 $\frac{7}{8}$ "	120	22 $\frac{3}{4}$ " x 12 $\frac{3}{8}$ "	22 $\frac{3}{4}$ " x 15 $\frac{5}{8}$ "	1540	NEMA 5-15P	92 lbs.	<b>\$7293</b>
<b>Dual Shelf with Humidity</b>								
<b>GRCMW-1DH**</b>	26" x 20 $\frac{1}{8}$ " x 26 $\frac{7}{8}$ "	120	22 $\frac{3}{4}$ " x 12 $\frac{3}{8}$ "	22 $\frac{3}{4}$ " x 15 $\frac{5}{8}$ "	1660	NEMA 5-15P	100 lbs.	<b>\$7802</b>

- \* Canadian models use NEMA 5-20P.
- \*\* Humidity on bottom shelf only.

**All Curved Merchandising Warmer Models Feature:**

Water Reservoir Capacity (GRCMW-1DH model only): 5 cups.

Cord Location: Server side, bottom right corner.

**WATER QUALITY REQUIREMENTS – PAGE 247**

**OPTIONS (available at time of purchase only)**

**Designer Colors (unit's painted surface) – Non-standard colors are non-returnable**

– **Black standard** –

<b>RED</b>	Warm Red	<b>No Charge</b>
<b>GRAY</b>	Gray Granite	<b>No Charge</b>
<b>WHITE</b>	White Granite	<b>No Charge</b>
<b>NAVY</b>	Navy Blue	<b>No Charge</b>
<b>GREEN</b>	Hunter Green	<b>No Charge</b>
<b>COPPER</b>	Antique Copper	<b>No Charge</b>

**Simulated Stone Color (unit's painted surface and decorative trim inserts)**

– **Non-standard colors are non-returnable** –

<b>GGRAN</b>	Gray Granite	<b>\$670</b>
<b>BSAND</b>	Bermuda Sand	<b>670</b>
<b>NSKY</b>	Night Sky	<b>670</b>

**CMWDBACKFLIP** Top and bottom shelf flip-up doors on server's side in lieu of mirrored back panel (GRCMW-1D, -1DH Models only) **\$ 45**

**CMWDTOPFLIP** Top Shelf Flip-up Door on Customer Side in lieu of Sneeze Guard (GRCMW-1D, -1DH Models only) **227**

**FOOD PANS AND TRIVETS – PAGE 245**

**COLORS AND FINISHES – INSIDE BACK COVER**

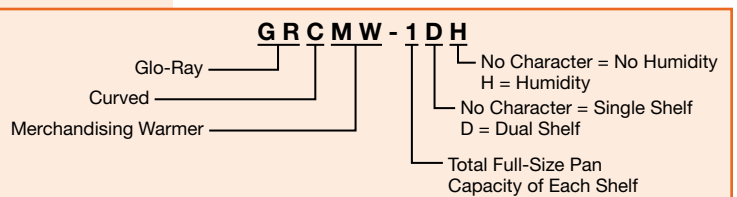



## Glo-Ray® Designer Heated Display Cases

Our Designer series Glo-Ray® Heated Display Case with curved glass and incandescent lighting will display your offering with flare and elegance. We combine our thermostatically-controlled heated base and infrared overhead heating to blanket your offering at the perfect temperature.

- The tempered curved glass design offers a great line of sight to draw in your customers
- Exclusive cool base construction
- Rollerless sliding doors
- Available with or without controlled humidity (bottom shelf only)
- Constructed of aluminum and stainless steel with tempered glass
- Curved glass front tilts forward for easy cleaning
- Pre-focused infrared top heat directs heat to the outer edges where heat loss is greatest
- Shatter-resistant incandescent lights illuminate the food product



Humidified reservoir is located in between pans



**GRCD-2P** with pan rail and optional Designer color, backlit sign holder (sign not included) and accessory food pans



**GRCD-2PD** with optional pan skirt, Designer Hunter Green and flip-up doors, and accessory food pans



**GRCDH-1PD** with pan skirt and new optional flip-up doors and accessory food pans. (top baking dish not available)



**GRCDH-3PD** shown in standard Stainless Steel with accessory food pans

Mercandisiers

### DESIGNER DISPLAY CASES

Model	No. of Bulbs	Dimensions (W x D x H) <i>Height includes legs</i>	Usable Heated Shelf Space (W x D)	Voltage Single Phase	Watts	Plug	Approx. Ship Weight	List Price
<b>Single Shelf</b>								
<b>GRCD-1P</b>	2	20 <sup>5</sup> / <sub>8</sub> " x 26" x 24"	18 <sup>1</sup> / <sub>8</sub> " x 21"	120	410	NEMA 5-15P	95 lbs.	<b>\$5593</b>
<b>GRCD-2P</b>	3	32 <sup>1</sup> / <sub>2</sub> " x 26" x 24"	30" x 21"	120	780	NEMA 5-15P	120 lbs.	<b>6391</b>
<b>GRCD-3P</b>	3	45 <sup>1</sup> / <sub>2</sub> " x 26" x 24"	43" x 21"	120	1005	NEMA 5-15P	152 lbs.	<b>7193</b>
<b>Dual Shelf</b>								
<b>GRCD-1PD</b>	4	20 <sup>5</sup> / <sub>8</sub> " x 26" x 31 <sup>3</sup> / <sub>4</sub> "	18 <sup>1</sup> / <sub>8</sub> " x 21"	120	860	NEMA 5-15P	98 lbs.	<b>\$6537</b>
<b>GRCD-2PD</b>	6	32 <sup>1</sup> / <sub>2</sub> " x 26" x 31 <sup>3</sup> / <sub>4</sub> "	30" x 21"	120	1210	NEMA 5-15P	170 lbs.	<b>7450</b>
<b>GRCD-3PD*</b>	6	45 <sup>1</sup> / <sub>2</sub> " x 26" x 31 <sup>3</sup> / <sub>4</sub> "	43" x 21"	120	1710	NEMA 5-15P	210 lbs.	<b>8590</b>
<b>Single Shelf with Humidity*</b>								
<b>GRCDH-1P</b>	2	20 <sup>5</sup> / <sub>8</sub> " x 26" x 24"	18 <sup>1</sup> / <sub>8</sub> " x 21"	120	660	NEMA 5-15P	90 lbs.	<b>\$6392</b>
<b>GRCDH-2P</b>	3	32 <sup>1</sup> / <sub>2</sub> " x 26" x 24"	30" x 21"	120	1030	NEMA 5-15P	124 lbs.	<b>7194</b>
<b>GRCDH-3P*</b>	3	45 <sup>1</sup> / <sub>2</sub> " x 26" x 24"	43" x 21"	120	1255	NEMA 5-15P	156 lbs.	<b>7995</b>
<b>Dual Shelf with Humidity*</b>								
<b>GRCDH-1PD</b>	4	20 <sup>5</sup> / <sub>8</sub> " x 26" x 31 <sup>3</sup> / <sub>4</sub> "	18 <sup>1</sup> / <sub>8</sub> " x 21"	120	1110	NEMA 5-15P	120 lbs.	<b>\$7337</b>
<b>GRCDH-2PD*</b>	6	32 <sup>1</sup> / <sub>2</sub> " x 26" x 31 <sup>3</sup> / <sub>4</sub> "	30" x 21"	120	1460	NEMA 5-15P	174 lbs.	<b>8253</b>
<b>GRCDH-3PD<sup>o</sup></b>	6	45 <sup>1</sup> / <sub>2</sub> " x 26" x 31 <sup>3</sup> / <sub>4</sub> "	43" x 21"	120	1960	NEMA 5-20P	220 lbs.	<b>9392</b>

- \* Canadian models use NEMA 5-20P.
- ♦ Humidity on bottom shelf only. Includes pan skirt on bottom shelf.
- <sup>o</sup> Not available for Canada with Backlit Base Sign Holder, and Canadian models use NEMA 5-30P.

**All Designer Display Case Models Feature:**  
**Water Reservoir Capacity (Humidified Models only):** 3 quarts.  
**Cord Location:** Server side, bottom right corner.

### OPTIONS – PAGE 178 WATER QUALITY REQUIREMENTS – PAGE 247

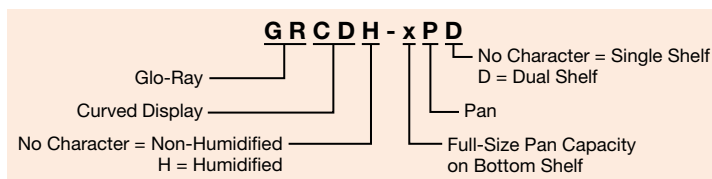



**GRCD-2PD** with optional self-closing flip-up doors and *Designer Warm Red*

### OPTIONS (available at time of purchase only)

#### Backlit Base Sign Holder, 120V only (Sign not included) –

<b>BCKLIT SIGN 2-PAN</b>	2-Pan Models (25 lbs.) Requires 32 $\frac{1}{8}$ "W x 5"H x $\frac{1}{16}$ "D Translucent Sign	<b>\$767</b>
<b>BCKLIT SIGN 3-PAN</b>	3-Pan Models (28 lbs.) Requires 45 $\frac{1}{8}$ "W x 5"H x $\frac{1}{16}$ "D Translucent Sign	<b>852</b>

#### Self-Closing Flip-Up Doors on both shelves on customer side in lieu of Glass Front (adds $\frac{1}{2}$ " depth to unit) –

<b>CD1PDFLIP</b>	1-Pan models	<b>\$ 888</b>
<b>CD2PDFLIP</b>	2-Pan models	<b>951</b>
<b>CD3PDFLIP</b>	3-Pan models	<b>1678</b>
<b>HAL</b>	60 Watt Halogen Bulb in lieu of Standard Display Light	<b>each \$69</b>

#### Pan Skirt on bottom shelf (accommodates 2 $\frac{1}{2}$ "D Pans – standard on humidified models) –

<b>SKIRT-1P</b>	1-Pan model in lieu of Pan Rail	<b>\$ 61</b>
<b>SKIRT-2P</b>	2-Pan model in lieu of Pan Rail	<b>110</b>
<b>SKIRT-3P</b>	3-Pan model in lieu of Pan Rail	<b>157</b>
<b>UPPERSKIRT-2P</b>	Pan Skirt for upper shelf of 2-Pan models	<b>112</b>
<b>UPPERSKIRT-3P</b>	Pan Skirt for upper shelf of 3-Pan models	<b>225</b>

#### Mirrored Glass Doors in lieu of Glass Doors (Server side only) –

##### Single Shelf Models –

<b>MIRROR-1P</b>	1-Pan single model	<b>add \$ 96</b>
<b>MIRROR-2P</b>	2-Pan single model	<b>add 134</b>
<b>MIRROR-3P</b>	3-Pan single model	<b>add 172</b>

##### Dual Shelf Models –

<b>MIRROR-1PD</b>	1-Pan dual model	<b>add \$192</b>
<b>MIRROR-2PD</b>	2-Pan dual model	<b>add 268</b>
<b>MIRROR-3PD</b>	3-Pan dual model	<b>add 387</b>

### OPTIONS (available at time of purchase only)

#### Designer Colors – Non-standard colors are non-returnable – Stainless Steel standard –

<b>RED</b>	Warm Red	<b>\$506</b>
<b>BLACK</b>	Black	<b>506</b>
<b>GRAY</b>	Gray Granite	<b>506</b>
<b>WHITE</b>	White Granite	<b>506</b>
<b>NAVY</b>	Navy Blue	<b>506</b>
<b>GREEN</b>	Hunter Green	<b>506</b>
<b>COPPER</b>	Antique Copper	<b>506</b>

#### COLORS AND FINISHES – INSIDE BACK COVER

### FOOD PANS AND TRIVETS – PAGE 245

#### HEATED DISPLAY CASE MAXIMUM PAN CAPACITIES\*

Model	Pan Capacity	Optional Pan Skirt Frames
<b>GRCD-1P</b>	1 Full-Size Pan	One SKIRT-1P
<b>GRCD-2P</b>	2 Full-Size Pans	One SKIRT-2P
<b>GRCD-3P</b>	3 Full-Size Pans	One SKIRT-3P
<b>GRCD-1PD</b>	<b>Top Shelf</b> 1 Half-Size Pan or 1-14" Pizza Pan	None
	<b>Bottom Shelf</b> 1 Full-Size Pan	One SKIRT-1P
<b>GRCD-2PD</b>	<b>Top Shelf</b> 1 Full-Size Pan and 1 Third-Size Pan or 2-14" Pizza Pans	One UPPERSKIRT-2P
	<b>Bottom Shelf</b> 2 Full-Size Pans	One SKIRT-2P
<b>GRCD-3PD</b>	<b>Top Shelf</b> 2 Full-Size Pans or 3-14" Pizza Pans	One UPPERSKIRT-3P
	<b>Bottom Shelf</b> 3 Full-Size Pans	One SKIRT-3P

\* All pan capacities shown are for non-humidified models.  
2 $\frac{1}{2}$ " deep pans recommended for bottom shelf of humidified models.

## Flav-R-Savor® Convected Air, Curved Front Display Cases

This front-of-the-house curved glass merchandiser utilizes convected air technology for superior holding times. Maintaining peak serving temperatures for unwrapped foods makes this Hatco display case perfect for cafeteria and deli-style service.

- Perforated stainless steel shelf not only enhances air movement over food products, but looks great as well
- Focused lighting to enhance and merchandise your food products
- Easy to read, digitally-controlled temperature and humidity (FSCDH-2PD model only) display for precise control
- Standard sign holder promotes your product offering on bottom front of unit (sign not included). Recommended sign dimension: 33 1/8"W x 6"H
- Rear French doors for easy access
- Hinged, tempered front glass panel tilts forward for easy cleaning

- Optional glass shelf available
- Night Sky Simulated Stone panel on bottom shelf is standard, optional in Gray Granite or Bermuda Sand. Non-standard colors are non-returnable
- Models with Simulated Stone are Swanstone®



**FSCDH-2PD** in standard *Designer* Black with sign holder (sign not included), 3-sided skirt, perforated shelf and Night Sky Simulated Stone base. Also with accessory risers and food pans.

### CONVECTED AIR, CURVED FRONT DISPLAY CASES

Model	Dimensions W x D x H	Voltage Single Phase	Watts	Plug	Approx. Ship Weight	List Price
<b>Non-Humidified</b>						
<b>FSCD-2PD</b>	34 3/8" x 30 3/8" x 31 1/8"	120	1800	NEMA 5-20P	205 lbs.	<b>\$8992</b>
<b>Humidified</b>						
<b>FSCDH-2PD</b>	34 3/8" x 31 7/8" x 31 1/8"	120/208-240	2805	NEMA L14-20P	190 lbs.	<b>\$9830</b>

#### All Convected Air Display Case Models Feature:

**Models Shipped With:** Perforated upper shelf, heated Simulated stone base shelf, three-sided skirt and sign holder on bottom front. (sign not included) (recommended sign dimension: 33 1/8"W x 6"H).

**Shelf Dimensions: Upper:** 31 1/4"W x 16"D.  
**Lower:** 32 1/4"W x 19 3/4"D.

**Water Reservoir Capacity (Humidified model only):** 7 quarts.

**Cord Location:** Server side, bottom center on left side of control box.

### WATER QUALITY REQUIREMENTS – PAGE 247

#### OPTIONS (available at time of purchase only)

**Designer Colors – Non-standard colors are non-returnable – Black standard –**

<b>RED</b>	Warm Red	<b>No Charge</b>
<b>GRAY</b>	Gray Granite	<b>No Charge</b>
<b>WHITE</b>	White Granite	<b>No Charge</b>
<b>NAVY</b>	Navy Blue	<b>No Charge</b>
<b>GREEN</b>	Hunter Green	<b>No Charge</b>
<b>COPPER</b>	Antique Copper	<b>No Charge</b>

**Simulated Stone Colors – Non-standard colors are non-returnable – Night Sky standard –**

<b>SS-GGRAN</b>	Gray Granite	<b>No Charge</b>
<b>SS-BSAND</b>	Bermuda Sand	<b>No Charge</b>
<b>FSCDH-PLUMB</b>	Valve Relocation allows draining from back of unit instead of directly under unit (Humidified model only)	<b>\$233</b>
<b>FSCD-GLASS</b>	Glass Center Shelf (in lieu of perforated metal shelf)	<b>No Charge</b>



**1RISER10**  
Accessory

#### ACCESSORIES (available for purchase at any time)

<b>1RISER10</b>	10"D x 1 1/4"H Circular Perforated Riser in Stainless Steel	<b>\$45</b>
-----------------	---	-------------

### COLORS AND FINISHES – INSIDE BACK COVER

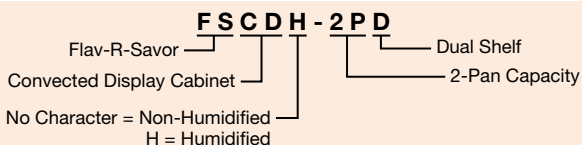



## Glo-Ray® Heated Display Cases

Designed for “show and sell” areas in any foodservice operation, the Hatco Glo-Ray® Heated Display is perfect for hot food merchandising. Top and bottom heat combine to keep all food at that “just-made” taste and temperature longer.

- Thermostatically-controlled heated base (100° - 200°F) to extend holding times
- Pre-focused infrared top heat directs heat to the outer edges where heat loss is greatest
- Constructed of aluminum and stainless steel with tempered glass
- Shatter-resistant incandescent lights illuminate the food product
- Exclusive cool base construction minimizes heat transfer, keeping exterior base cool
- Rollerless sliding doors



**GRHD-4PD** with optional *Designer Antique Copper* and mirrored glass doors and accessory food pans



**GRHDH-2P** with standard pan skirt, optional double side opening, and accessory food pans

Merchandisers

### DISPLAY CASES

Model	No. of Bulbs	Dimensions W x D x H (Height includes legs)	Voltage	Watts	Plug	Approx. Ship Weight	List Price
<b>Single Shelf</b>							
GRHD-2P	4	32½" x 26" x 25"	120	940	NEMA 5-15P	120 lbs.	<b>\$4882</b>
GRHD-3P	5	45½" x 26" x 25"	120	1350	NEMA 5-15P	143 lbs.	<b>5587</b>
GRHD-4P <sup>♣</sup>	6	58½" x 26" x 25"	120	1785	NEMA 5-15P	215 lbs.	<b>6603</b>
<b>Dual Shelf</b>							
GRHD-2PD	6	32½" x 26" x 30"	120	1310	NEMA 5-15P	150 lbs.	<b>\$6736</b>
GRHD-3PD <sup>♣</sup>	8	45½" x 26" x 30"	120	1755	NEMA 5-15P	188 lbs.	<b>7568</b>
GRHD-4PD <sup>♣</sup>	8	58½" x 26" x 30"	120	2480	NEMA 5-30P	230 lbs.	<b>8700</b>
<b>Single Shelf with Humidity</b>							
GRHDH-2P	4	32½" x 26" x 25"	120	1190	NEMA 5-15P	125 lbs.	<b>\$5716</b>
GRHDH-3P <sup>♣</sup>	5	45½" x 26" x 25"	120	1600	NEMA 5-15P	162 lbs.	<b>6421</b>
GRHDH-4P <sup>♣</sup>	6	58½" x 26" x 25"	120	2285	NEMA 5-30P	215 lbs.	<b>8028</b>
<b>Dual Shelf with Humidity</b>							
GRHDH-2PD <sup>♣♣</sup>	6	32½" x 26" x 30"	120	1560	NEMA 5-15P	175 lbs.	<b>\$ 7563</b>
GRHDH-3PD <sup>♣♣</sup>	8	45½" x 26" x 30"	120	2005	NEMA 5-20P	188 lbs.	<b>8394</b>
GRHDH-4PD <sup>♣♣</sup>	8	58½" x 26" x 30"	120	2980	NEMA 5-30P	240 lbs.	<b>10120</b>

<sup>♣</sup> Also available in 120/208V or 120/240V.

<sup>♣♣</sup> Canadian models use NEMA 5-20P.

<sup>♣</sup> Humidity on bottom shelf only. Includes pan skirt on bottom shelf.

<sup>♣♣</sup> Canadian model uses NEMA 5-30P.

<sup>⊙</sup> Not available in 120V for Canada.

#### All Display Case Models Feature:

**Usable Heated Shelf Space:** Width of unit minus 4½" x 21½"D.

**Water Reservoir Capacity (Humidified models only):** 2-Pan and 3-Pan: 3 quarts.

4-Pan: 6 quarts.

**Doors:** Separate rollerless sliding door per shelf.

**Cord Location:** Server side, bottom right corner.

#### OPTIONS AND ACCESSORIES – PAGE 181

#### WATER QUALITY REQUIREMENTS – PAGE 247

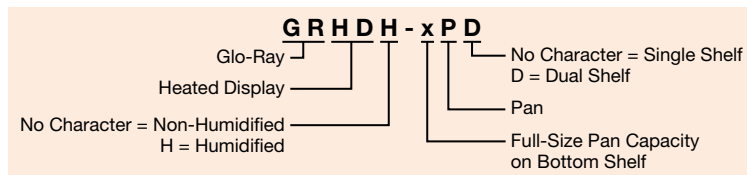





**GRHD-4PD** with optional pan skirts  
 Top shelf: one **UPPERSKIRT-4P**  
 Bottom shelf: one **SKIRT-4P**

Merchandisers

**OPTIONS** (available at time of purchase only)

<b>SKIRT-2P</b>	Pan Skirt on bottom shelf (standard on Humidified models) 2-Pan model in lieu of Pan Rail	<b>\$116</b>
<b>SKIRT-3P</b>	Pan Skirt on bottom shelf (standard on Humidified models) 3-Pan model in lieu of Pan Rail (consists of one SKIRT-1P and one SKIRT-2P)	<b>162</b>
<b>SKIRT-4P</b>	Pan Skirt on bottom shelf (standard on Humidified models) 4-Pan model in lieu of Pan Rail (consists of two SKIRT-2P)	<b>231</b>
<b>UPPERSKIRT-2P</b>	Pan Skirt for upper shelf of 2-Pan models in lieu of Pan Stop	<b>116</b>
<b>UPPERSKIRT-3P</b>	Pan Skirt for upper shelf of 3-Pan models in lieu of Pan Stop	<b>231</b>
<b>UPPERSKIRT-4P</b>	Pan Skirt for upper shelf of 4-Pan models in lieu of Pan Stop	<b>231</b>
<b>HAL</b>	60 Watt Halogen Bulb in lieu of Standard Display Light	<b>each 69</b>
<b>FLIP</b>	Flip-Up Doors on control side in lieu of Glass Sliding Doors	<b>No Charge</b>
<b>Sliding Door in lieu of Fixed Glass customer panel –</b>		
<b>SLIDE-2P</b>	Per opening	<b>\$240</b>
<b>SLIDE-3P</b>	Per opening	<b>264</b>
<b>SLIDE-4P</b>	Per opening	<b>329</b>
<b>Flip-Up Door in lieu of Fixed Glass customer panel –</b>		
<b>FLIP-2P</b>	Per opening	<b>\$240</b>
<b>FLIP-3P</b>	Per opening	<b>264</b>
<b>FLIP-4P</b>	Per opening	<b>329</b>
<b>Mirror Glass Sliding Door in lieu of Glass Sliding Door (server side only) –</b>		
<b>MIRROR-2P</b>	Per opening	<b>\$138</b>
<b>MIRROR-3P</b>	Per opening	<b>176</b>
<b>MIRROR-4P</b>	Per opening	<b>218</b>

**OPTIONS** (available at time of purchase only)

**Designer Colors – Non-standard colors are non-returnable – Stainless Steel standard –**

<b>RED</b>	Warm Red	<b>\$506</b>
<b>BLACK</b>	Black	<b>506</b>
<b>GRAY</b>	Gray Granite	<b>506</b>
<b>WHITE</b>	White Granite	<b>506</b>
<b>NAVY</b>	Navy Blue	<b>506</b>
<b>GREEN</b>	Hunter Green	<b>506</b>
<b>COPPER</b>	Antique Copper	<b>506</b>

**FOOD PANS AND TRIVETS – PAGE 245**  
**COLORS AND FINISHES – INSIDE BACK COVER**

**HEATED DISPLAY CASE MAXIMUM PAN CAPACITIES\***

Model	Pan Capacity	Optional Pan Skirt Frames
<b>GRHD-2P</b>	2 Full-Size Pans	One SKIRT-2P
<b>GRHD-3P</b>	3 Full-Size Pans	One SKIRT-3P
<b>GRHD-4P</b>	4 Full-Size Pans	One SKIRT-4P
<b>GRHD-2PD</b>	<b>Top Shelf</b> 2 Half-Size Pans or 2-14" Pizza Pans	One UPPERSKIRT-2P
	<b>Bottom Shelf</b> 2 Full-Size Pans	One SKIRT-2P
<b>GRHD-3PD</b>	<b>Top Shelf</b> 3 Half-Size Pans or 3-14" Pizza Pans	One UPPERSKIRT-3P
	<b>Bottom Shelf</b> 3 Full-Size Pans	One SKIRT-3P
<b>GRHD-4PD</b>	<b>Top Shelf</b> 2 Full-Size Pans or 4 Half-Size Pans or 4-14" Pizza Pans	One UPPERSKIRT-4P
	<b>Bottom Shelf</b> 4 Full-Size Pans	One SKIRT-4P

\* All pan capacities shown are for non-humidified models. 2½" deep pans recommended for bottom shelf of humidified models.

# Holding & Display Cabinets

*Cafeterias • Convenience Stores  
Catering • Concessions*



**PWC-12** in optional *Designer Black* pg. 183



**FSDT-2X** with accessory 4-shelf multi-purpose rack, and optional sign holder (sign not included) pg. 185



**IHDC-45** with accessory risers and sign holders pg. 189



**MDW-1X** with optional *Designer Black* and hood with backlit sign cut out on one side (sign included) pg. 193



**FST-1-MN** shown in standard *Bronze* pg. 194



**FSHC-7W1-EE** shown in *Designer Black*, with optional bumper kit, and right-hand hinged door pg. 196



**FSHC-17W1** with accessory food pans pg. 199



**FS2HAC-2PT** Pass-through with accessory food pans pg. 201



**FS2HAC-15** With third-size food pans (pans not included) pg. 201

## Plate Warmers

Hatco's Plate Warmers are designed to hold preheated serving plates where your customers can access them easily. Countertop or Built-In models available. Easy to load and easy to clean. Serving hot food on preheated plates will help extend the holding times of most foods, and adds to a better customer experience.

- Can hold 25 plates up to 12" in diameter
- A covered, digital temperature control with an adjustable range of 104° - 122°F
- Energy efficient LED lighting illuminates the interior from the top
- Available in Stainless Steel or *Designer Black* powdercoating
- Cabinet cutout dimensions are: 16<sup>5</sup>/<sub>8</sub>" x 20<sup>1</sup>/<sub>8</sub>"



**PWB-12**  
in standard  
Stainless Steel



**PWC-12**  
in optional *Designer Black*

Holding &  
Display Cabinets

### PLATE WARMERS

Model	Item Number	Description	Dimensions (W x D x H †)	Opening Dimensions (W x H)	Voltage	Watts	Amps	Approx. Ship Weight	List Price
<b>Countertop</b>									
<b>PWC-12</b>	PWC.12SS515	Countertop, Stainless Steel	16 <sup>7</sup> / <sub>8</sub> " x 17 <sup>3</sup> / <sub>8</sub> " x 22 <sup>3</sup> / <sub>8</sub> "	12 <sup>5</sup> / <sub>8</sub> " x 15 <sup>3</sup> / <sub>4</sub> "	120	460	3.8	64 lbs.	<b>\$2232</b>
<b>Built-In</b>									
<b>PWB-12</b>	PWB.12SS515	Built-In, Stainless Steel	17 <sup>1</sup> / <sub>2</sub> " x 17 <sup>1</sup> / <sub>2</sub> " x 21 <sup>1</sup> / <sub>8</sub> "	12 <sup>3</sup> / <sub>4</sub> " x 15 <sup>3</sup> / <sub>4</sub> "	120	460	3.8	49 lbs.	<b>2018</b>

† Height includes standard 1" legs.

#### All Plate Warmer Models Feature:

##### Models Shipped with:

**PWC-12:** Power On/Off switch, a detachable 6' power cord, a 3' jumper cord and a wall-mounting kit, NEMA 5-15P plug.

**PWB-12:** Power On/Off switch, a detachable 6' power cord and a 3' jumper cord, NEMA 5-15P plug.

**Cabinet cut-out dimensions for PWB-12:** 16<sup>3</sup>/<sub>4</sub>" W x 20<sup>1</sup>/<sub>4</sub>" H.

**Cord Location:** back of unit, top left corner.

### OPTIONS (available at time of purchase only)

**Designer Color – Non-standard colors are non-returnable – Stainless Steel Standard – BLACK** *Designer Black* **\$398**

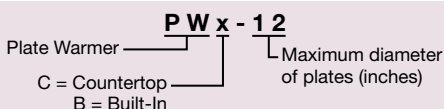

## Flav-R-Fresh® Humidified Impulse Display Cabinets

A profitable way to create impulse food sales is with the small Flav-R-Fresh® Holding and Display Cabinet. Using controlled moisturized heat allows you to showcase your product longer using minimum counter space.

- Full-view display with tempered glass sides and door
- Controlled heat and humidity for longer holding times
- Accommodates half-size sheet pans
- Revolving or stationary display racks
- Single- or reversible double-sided opening models
- LED lights illuminate the holding areas and emphasize the product



**FDWD-2** with accessory 4-tier circle rack

### IMPULSE CABINETS

Model*	Description†	Dimensions W x D x H ‡	Cabinet Opening W x H	Voltage Single Phase	Watts	Approx. Ship Weight	List Price*
<b>FDWD-1</b>	1 Door w/4-Tier Circle Rack w/Motor	19 <sup>3</sup> / <sub>8</sub> " x 20 <sup>7</sup> / <sub>8</sub> " x 28 <sup>7</sup> / <sub>8</sub> "	15 <sup>3</sup> / <sub>4</sub> " x 19 <sup>3</sup> / <sub>4</sub> "	120	1360	90 lbs.	<b>\$4449</b>
<b>FDWD-1X</b>	1 Door w/4-Shelf Multi-Purpose Rack w/o Motor	19 <sup>3</sup> / <sub>8</sub> " x 20 <sup>7</sup> / <sub>8</sub> " x 28 <sup>7</sup> / <sub>8</sub> "	15 <sup>3</sup> / <sub>4</sub> " x 19 <sup>3</sup> / <sub>4</sub> "	120	1360	90 lbs.	<b>4312</b>
<b>FDWD-2</b>	2 Doors w/4-Tier Circle Rack w/Motor	19 <sup>3</sup> / <sub>8</sub> " x 22" x 28 <sup>7</sup> / <sub>8</sub> "	15 <sup>3</sup> / <sub>4</sub> " x 19 <sup>3</sup> / <sub>4</sub> "	120	1360	90 lbs.	<b>4589</b>
<b>FDWD-2X</b>	2 Doors w/4-Shelf Multi-Purpose Rack w/o Motor	19 <sup>3</sup> / <sub>8</sub> " x 22" x 28 <sup>7</sup> / <sub>8</sub> "	15 <sup>3</sup> / <sub>4</sub> " x 19 <sup>3</sup> / <sub>4</sub> "	120	1360	90 lbs.	<b>4444</b>

\* Models FDWD-1 and FDWD-2 include rack motor. Models with "X" designator do not have revolving display and are NOT available for retrofit.

† Rack listed is included with unit. Other racks available – deduct price of included rack and add price of substituted rack to list price.

‡ Height includes standard 1" legs.

\* For non-humidified cabinet, deduct \$210. Unit will only operate in dry mode.

#### All Impulse Cabinet Models Feature:

**Voltage:** 60 Hz, 11.3 amps, NEMA 5-15P plug.

**Door Hinges – Control Side and Customer Side (two-door models only):** Left-hand side.

**Max. Pizza Size:** 15" diameter with 4-Tier Circle Rack.

**Water Tank Capacity for Humidity System:** ½ gallon.

**Cord Location:** Facing controls, left-hand side panel, lower right corner.

### WATER QUALITY REQUIREMENTS – PAGE 247

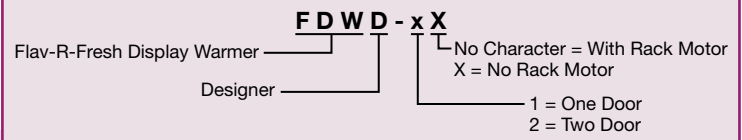

### OPTIONS (available at time of purchase only)

**Designer Colors – Non-standard colors are non-returnable – Clear Anodized Aluminum Standard –**

<b>RED</b>	Warm Red	<b>\$506</b>
<b>BLACK</b>	Black	<b>506</b>
<b>GRAY</b>	Gray Granite	<b>506</b>
<b>WHITE</b>	White Granite	<b>506</b>
<b>NAVY</b>	Navy Blue	<b>506</b>
<b>GREEN</b>	Hunter Green	<b>506</b>
<b>COPPER</b>	Antique Copper	<b>506</b>
<b>LED-NW18</b>	Neutral White (cool) LED lighting (in lieu of standard Warm White)	<b>No Charge</b>
<b>FDWD-SCD</b>	Self Closing Door in lieu of standard door (left hinge only). Must upgrade both doors on FDWD-2, -2X (not field reversible)	<b>per door \$ 90</b>
<b>FDWD-6FRT</b>	6" Merchandising Display Sign Holder for Control Side only (Includes metal holder only). Available in all Designer Colors to match your unit (Black is standard). Adds 1 <sup>1</sup> / <sub>8</sub> " to height of unit. Requires (1) sign 19 <sup>3</sup> / <sub>16</sub> "W x 6 <sup>3</sup> / <sub>16</sub> "H x 1 <sup>1</sup> / <sub>16</sub> "D – not included	<b>121</b>
<b>FDWD-DIS</b>	3" One Sided Merchandising Display Sign Holder (includes metal holder and window) – <b>one per side</b> , three maximum. Available in all Designer Colors to match your unit (Black is standard). Adds 1 <sup>1</sup> / <sub>4</sub> " to height of unit. Requires (1) sign 19 <sup>3</sup> / <sub>16</sub> "W x 3 <sup>3</sup> / <sub>4</sub> "H x 1 <sup>1</sup> / <sub>16</sub> "D – not included	<b>86</b>
<b>FDWD-6SIGN</b>	6 <sup>3</sup> / <sub>8</sub> " One-Sided Merchandising Display Sign Holder (includes metal holder and window) – <b>one per side</b> , three maximum. Available in all Designer Colors to match your unit (Black is standard). Adds 1 <sup>1</sup> / <sub>4</sub> " to height of unit. Requires (1) sign 19 <sup>3</sup> / <sub>16</sub> "W x 6 <sup>3</sup> / <sub>4</sub> "H x 1 <sup>1</sup> / <sub>16</sub> "D – not included	<b>94</b>

### ACCESSORIES (available for purchase at any time)

<b>FDWD-LEGS</b>	4" Adjustable Legs (4"-5")	<b>\$ 89</b>
<b>COUPLING</b>	Motorless Rack Coupling for FDWD-1X and FDWD-2X models (select Circle Rack or Pretzel Tree)	<b>49</b>
<b>FDWD4TCRR</b>	4-Tier Circle Rack with Pizza Pan Retainers (Requires Coupling for -1X or -2X models)	<b>266</b>
<b>FDW4SMP</b>	4-Shelf Multi-Purpose Rack (each shelf 13 <sup>5</sup> / <sub>8</sub> "W x 12 <sup>5</sup> / <sub>8</sub> "D)	<b>301</b>
<b>FDW3TPT</b>	3-Tier Pretzel Tree (requires Coupling for -1X or -2X models)	<b>301</b>

### DECORATIVE KIT – PAGE 187

### RACKS – PAGE 188

### FOOD PANS AND TRIVETS – PAGE 245

### COLORS AND FINISHES – INSIDE BACK COVER



**COUPLING**  
Accessory



## Flav-R-Savor® Humidified Holding & Display Cabinets

Balancing a precise combination of heat and humidity, the Hatco Flav-R-Savor® Cabinets provide an attractive showcase for hot food displays and generate impulse sales. A complete range of cabinet sizes, door options and rack types allows for perfect merchandising of food products such as pizza, fried foods, bakery items, sandwiches and more.

- Full-view display with tempered glass sides and door provide maximum heat retention
- Controlled heat and humidity for longer holding times
- ¾ gallon stainless water reservoir provides all day moisture
- Low-water protection prevents heating element burnout and alerts operator to low-water condition
- Revolving or stationary display racks
- Available in two heights with single-sided or double-sided openings
- Energy efficient LED lighting to illuminate your food display



FSD-1 with 3-tier pan rack and accessory food pans



FSDDT-1 with 4-tier circle rack and 4" legs, optional Designer Black color and accessory food pans

Holding & Display Cabinets

### DISPLAY CABINETS

Model*	Description*	Dimensions W x D x H	Approx. Ship Weight	List Price*
<b>Standard</b>				
FSD-1	1 Door w/3-Tier Circle Rack w/Motor	22½" x 24½" x 27⅝"	129 lbs.	\$5383
FSD-1X	1 Door w/3-Tier Pan Rack w/o Motor	22½" x 24½" x 27⅝"	126 lbs.	5221
FSD-2	2 Doors w/3-Tier Circle Rack w/Motor	22½" x 25⅝" x 27⅝"	126 lbs.	5748
FSD-2X	2 Doors w/3-Tier Pan Rack w/o Motor	22½" x 25⅝" x 27⅝"	126 lbs.	5590
<b>Tall</b>				
FSDDT-1	1 Door w/4-Tier Circle Rack w/Motor	22½" x 24½" x 32⅝"	128 lbs.	\$5473
FSDDT-1X	1 Door w/4-Tier Pan Rack w/o Motor	22½" x 24½" x 32⅝"	126 lbs.	5259
FSDDT-2	2 Doors w/4-Tier Circle Rack w/Motor	22½" x 25⅝" x 32⅝"	126 lbs.	5907
FSDDT-2X	2 Doors w/4-Tier Pan Rack w/o Motor	22½" x 25⅝" x 32⅝"	126 lbs.	5697

- ♦ Models FSD-1, FSD-2, FSDDT-1 and FSDDT-2 include rack motor. Models with "X" designator do not have revolving display and are NOT available for retrofit.
- ‡ Rack listed is included with unit. Other racks available.
- \* For non-humidified cabinet, unit will only operate in dry mode.

#### All Display Cabinet Models Feature:

**Voltage:** 120, single phase, 60 Hz, 1414 watts, 11.8 amps, NEMA 5-15P plug.

**Cabinet Opening Dimensions: Standard Models:** 19"W x 18⅝"H.

**Tall Models:** 19"W x 23¾"H.

**Door Hinges: Control Side:** Left-hand side.

**Customer Side (two-door models only):** Right-hand side.

**Max. Pan Size:** 19" diameter with 4-Tier Circle Rack.

**Water Tank Capacity for Humidity System:** ¾ gallon.

**Cord Location:** Facing controls, left-hand side panel, lower right corner.

#### OPTIONS AND ACCESSORIES – PAGE 186

#### DECORATIVE KIT – PAGE 187

#### RACKS – PAGE 188

#### FOOD PANS AND TRIVETS – PAGE 245

#### WATER QUALITY REQUIREMENTS – PAGE 247

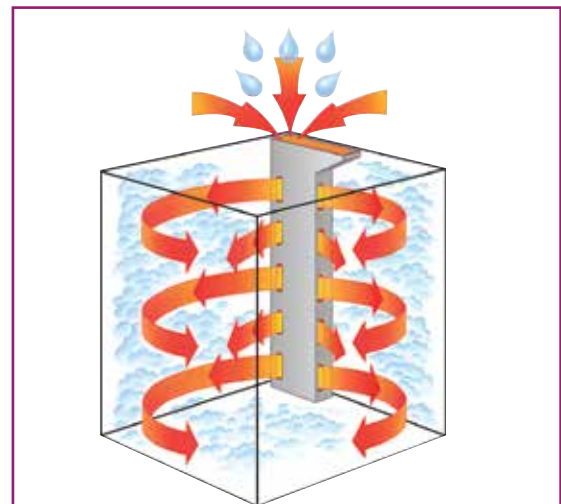

**CONTROLLED MOISTURIZED HEAT KEEPS HOT FOODS FRESH LONGER** Hatco's Flav-R-Savor® air flow pattern is designed to maintain consistent cabinet temperature without drying out foods. The precise combination of heat and humidity creates a "blanket" effect around the food. The air flow rate enables the cabinet to recover temperature rapidly after opening and closing the door.

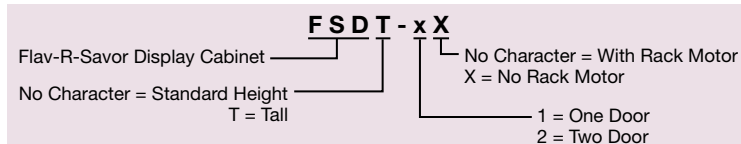



Two FSDT-1 with 4-tier circle racks, optional sign holders (signs not included) and accessory food pans

**OPTIONS** (available at time of purchase only)

<b>LED-NW18</b>	Neutral White (cool) LED lighting (in lieu of standard Neutral White)	<b>No Charge</b>
<b>THERM</b>	Mechanical Controls	<b>No Charge</b>
<b>FSD7SIGN</b>	7½" Merchandising Display Sign Holder (includes metal holder and window) – <b>one per side</b> , three maximum. Available in all <i>Designer Colors</i> to match your unit (Black is standard). Adds 1¼" to height of unit. Requires (1) sign 22½"W x 7½"H x 1/16"D – not included	<b>\$98</b>

**ACCESSORIES** (available for purchase at any time)

<b>F-LEGS-4</b>	4" Adjustable Legs	<b>\$89</b>
<b>COUPLING</b>	Motorless Rack Coupling for FSD-1X, FSD-2X, FSDT-1X and FSDT-2X models (select appropriate Circle Rack or Pretzel Tree)	<b>49</b>
<b>RACKS – FSD ONLY –</b>		
<b>FSD5SMP</b>	5-Shelf Multi-Purpose Rack (each shelf - 18"W x 16"D)	<b>\$405</b>
<b>FSD3TCR</b>	3-Tier Circle Rack with Pizza Pan Retainers (requires Coupling for -1X or -2X models)	<b>248</b>
<b>FSD3TPR</b>	3-Tier Pan Rack (accommodates Half-Size Sheet Pans, not included)	<b>358</b>
<b>RACKS – FSDT ONLY –</b>		
<b>FSDT7SMP</b>	7-Shelf Multi-Purpose Rack (each shelf - 18"W x 16"D)	<b>\$496</b>
<b>FSDT4TCR</b>	4-Tier Circle Rack with Pizza Pan Retainers (requires Coupling for -1X or -2X models)	<b>264</b>
<b>FSDT5TCR</b>	5-Tier Circle Rack with Pizza Pan Retainers (requires Coupling for -1X or -2X models)	<b>401</b>
<b>FSDT4TPR</b>	4-Tier Pan Rack (accommodates Half-Size Sheet Pans, not included)	<b>317</b>
<b>FSDT3SAR</b>	3-Shelf Angle Rack (15° angle shelves) (each shelf - 18"W x 16¼"D)	<b>915</b>
<b>FSDT3TPT</b>	3-Tier Pretzel Tree (requires Coupling for -1X or -2X models)	<b>432</b>

**DECORATIVE KIT – PAGE 187**

**RACKS – PAGE 188**

**FOOD PANS AND TRIVETS – PAGE 245**

**COLORS AND FINISHES – INSIDE BACK COVER**

**OPTIONS** (available at time of purchase only)

**Designer Colors**

– *Non-standard colors are non-returnable*

– *Clear Anodized Aluminum Standard –*

<b>RED</b>	Warm Red	<b>\$506</b>
<b>BLACK</b>	Black	<b>506</b>
<b>GRAY</b>	Gray Granite	<b>506</b>
<b>WHITE</b>	White Granite	<b>506</b>
<b>NAVY</b>	Navy Blue	<b>506</b>
<b>GREEN</b>	Hunter Green	<b>506</b>
<b>COPPER</b>	Antique Copper	<b>506</b>

## Decorative Kit for FDWD, FSD, FSDT models only

Transform your Hatco Flav-R-Savor® Holding & Display Cabinet from a "heated box" into a *Designer Merchandiser* with a variety of simple accessory additions. Create a new look and feel to your decór.

- The curved hinged header allows easy access to controls and water fill cup, and gives a great area to brand your food product with a magnetic sign (sign not included)
- The base skirt completes the transformation and gives an additional branding area. Available in flat or curved panels for front and/or back of unit
- Signs can be decals or magnetic
- Signs not included

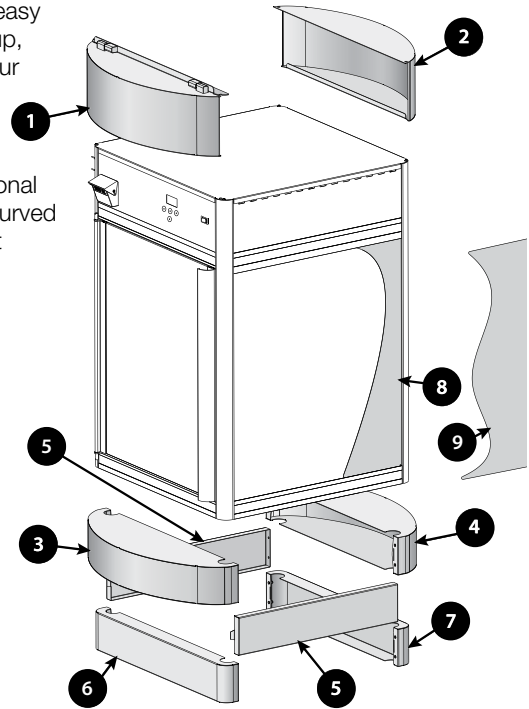

### OPTIONS (available at time of purchase only) (additional lead time required)

Designer Colors – Non-standard colors are non-returnable – Black Standard –			
RED	WR	Warm Red	No Charge
GRAY	GG	Gray Granite	No Charge
WHITE	WG	White Granite	No Charge
NAVY	NB	Navy Blue	No Charge
GREEN	HG	Hunter Green	No Charge
COPPER	AC	Antique Copper	No Charge

### ACCESSORIES (available for purchase at any time)

#### Side Insets – Must choose Designer Color – Black Standard –

FSD-INSET1	Two Crescent Inset Panels for FSD models	\$97
FSD-INSET2	Two Wave Inset Panels for FSD models	97
FSDT-INSET1	Two Crescent Inset Panels for FSDT models	97
FSDT-INSET2	Two Wave Inset Panels for FSDT models	97
FDWD-INSET1	Two Crescent Inset Panels for FDWD models	97
FDWD-INSET2	Two Wave Inset Panels for FDWD models	97

#### Top Covers – Must choose Designer Color – Black Standard – – Signs not Included –

FSD-CTLH	Curved Hinged Header on control side (Fits 24"W x 5 <sup>7</sup> / <sub>8</sub> "H sign) for FSD and FSDT models	\$335
FDWD-CTLH	Curved Hinged Header on control side (Fits 20 <sup>1</sup> / <sub>2</sub> "W x 4 <sup>7</sup> / <sub>8</sub> "H sign) for FDWD models	285
FSD-CUSH	Curved Header on non-control side (Fits 24"W x 5 <sup>7</sup> / <sub>8</sub> "H sign) for FSD and FSDT models	244
FDWD-CUSH	Curved Header on non-control side (Fits 20 <sup>1</sup> / <sub>2</sub> "W x 4 <sup>7</sup> / <sub>8</sub> "H sign) for FDWD models	209

#### Base Skirts – Requires 4" adjustable legs (not included) – Must choose Designer Color – Black Standard – Signs not Included –

FSD-SQB	One Flat Front Panel 6 and one Flat Back Panel 7 (Fits 20"W x 3 <sup>3</sup> / <sub>4</sub> "H sign) and two Flat Side Panels 5 (Fits 18 <sup>7</sup> / <sub>8</sub> "W x 3 <sup>5</sup> / <sub>8</sub> "H sign) for FSD and FSDT models	\$289
FDWD-SQB	One Flat Front Panel 6 and one Flat Back Panel 7 (Fits 17 <sup>1</sup> / <sub>4</sub> "W x 3 <sup>3</sup> / <sub>4</sub> "H sign) and two Flat Side Panels 5 (Fits 15 <sup>1</sup> / <sub>2</sub> "W x 3 <sup>3</sup> / <sub>4</sub> "H sign) for FDWD models	376
FSD-1CB	One Curved Front Panel 3 and one Flat Back Panel 7 (Fits 25 <sup>1</sup> / <sub>2</sub> "W x 3 <sup>5</sup> / <sub>8</sub> "H sign) and two Flat Side Panels 5 (Fits 18 <sup>7</sup> / <sub>8</sub> "W x 3 <sup>5</sup> / <sub>8</sub> "H sign) for FSD and FSDT models	518
FDWD-1CB	One Curved Front Panel 3 and one Flat Back Panel 7 (Fits 22 <sup>1</sup> / <sub>4</sub> "W x 3 <sup>3</sup> / <sub>4</sub> "H sign) and two Flat Side Panels 5 (Fits 15 <sup>1</sup> / <sub>2</sub> "W x 3 <sup>3</sup> / <sub>4</sub> "H sign) for FDWD models	504
FSD-2CB	One Curved Front Panel 3 and one Curved Back Panel 4 (Fits 25 <sup>1</sup> / <sub>2</sub> "W x 3 <sup>5</sup> / <sub>8</sub> "H sign) and two Flat Side Panels 5 (Fits 18 <sup>7</sup> / <sub>8</sub> "W x 3 <sup>5</sup> / <sub>8</sub> "H sign) for FSD and FSDT models	746
FDWD-2CB	One Curved Front Panel 3 and one Curved Back Panel 4 (Fits 22 <sup>1</sup> / <sub>4</sub> "W x 3 <sup>3</sup> / <sub>4</sub> "H sign) and two Flat Side Panels 5 (Fits 15 <sup>1</sup> / <sub>2</sub> "W x 3 <sup>3</sup> / <sub>4</sub> "H sign) for FDWD models	635
F-LEGS-4	4" Adjustable Legs for FSD and FSDT models	\$89
FDWD-LEGS	4" Adjustable Legs for FDWD models	89

### COLORS AND FINISHES – INSIDE BACK COVER



FSDT-1 with 4-tier circle rack and full Decorative Kit (signs not included)



## Display Rack Selections

### Racks For FDWD Models (Page 184)

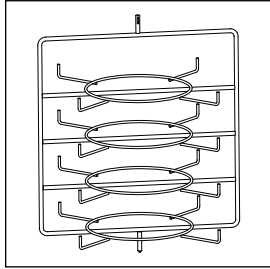

**4-Tier Circle Rack**  
**FDWD4TCRR**  
(Max. 15" dia. pans)  
(3¼" between tiers)

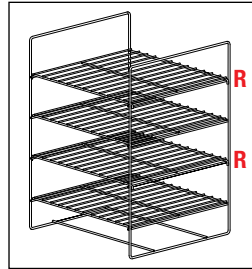

**4-Shelf Multi-Purpose Rack**  
**FDW4SMP** (Max. 18" x 13")  
(Half-Size Sheet Pans fit  
FDWD-2 and -2X models only)  
(3¾" between shelves)

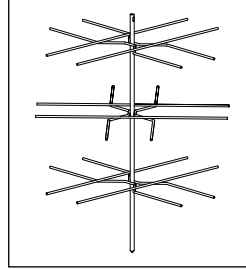

**3-Tier Pretzel Tree**  
**FDW3TPT**  
(5⅞" between tiers)

### Racks For FSD Models (Page 185)

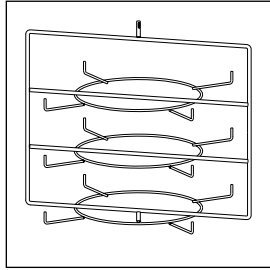

**3-Tier Circle Rack**  
**FSD3TCR**  
(4⅝" between tiers)

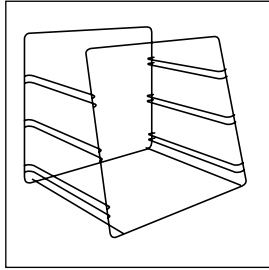

**3-Tier Pan Rack**  
**FSD3TPR**  
(3½" between shelves)

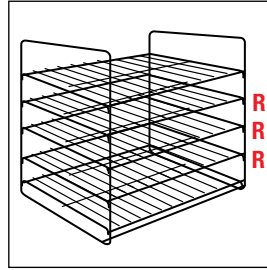

**5-Shelf Multi-Purpose Rack**  
**FSD5SMP**  
(2½" between shelves)

### Racks For FSDT Models (Page 185)

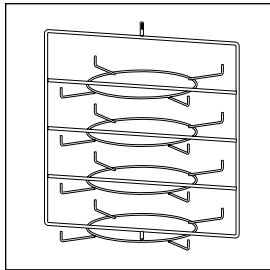

**4-Tier Circle Rack**  
**FSDT4TCR**  
(Max. 19" dia. pans)  
(4⅝" between tiers)

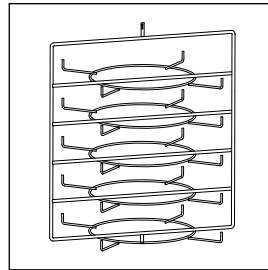

**5-Tier Circle Rack**  
**FSDT5TCR**  
(Max. 19" dia. pans)  
(3⅞" between tiers)

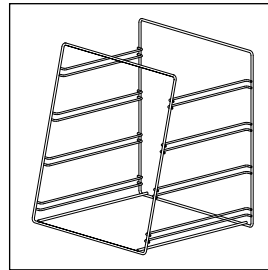

**4-Tier Pan Rack**  
**FSDT4TPR**  
(Max. 18" x 13" Half-Size Sheet  
Pans) (3½" between tiers)

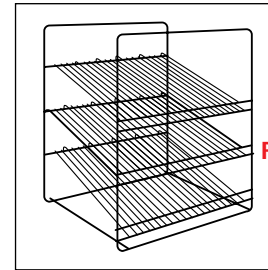

**3-Shelf Angle Rack**  
**FSDT3SAR**  
(3½" between shelves)

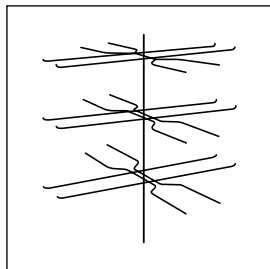

**3-Tier Pretzel Tree**  
**FSDT3TPT**  
(5⅞" between tiers)

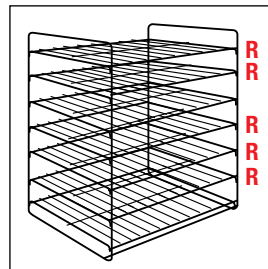

**7-Shelf Multi-Purpose Rack**  
**FSDT7SMP**  
(Max. 18" x 13" Half-Size Sheet  
Pans) (2½" between shelves)

**R** Removable Shelves



## Intelligent Heated Display Cabinet, Humidified

Hatco's Intelligent Heated Display Cabinet Humidified is the perfect way to showcase your pizzas and more. Regulating air temperature while at the same time balancing the humidity levels provides the best environment for food products. With 360° viewing, your food is guaranteed to get all the attention.

- Air flow pattern is designed to maintain consistent cabinet temperature without drying out food
- Air flow system enables the cabinet to recover temperature rapidly after opening and closing the door
- LCD touchscreen display on back of unit controls temperature, humidity and up to eight timers for each food location
- Energy efficient LED lighting to illuminate your food display
- USB port on back of unit makes it easy to update firmware
- Adjustable arms can move up and down the back supports
  - IHDCH-45 can hold up to six pizza arms, can be adjusted up to 19.5" and can hold up to 8.5 lbs.
  - IHDCH-28 arms will hold up to a 22" pizza pan



**IHDCH-45**  
shown with three optional shelves and French Front Doors



**IHDCH-45**  
shown with accessory arms and risers



**IHDCH-28**  
shown with accessory two arms and one shelf

Holding & Display Cabinets

**NOTE:** Water filter, water strainer and plastic tubing are included with each cabinet to be installed on water supply connection.

### INTELLIGENT HEATED DISPLAY CABINETS – HUMIDIFIED

Model	Dimensions W x D x H	Cabinet Opening Dimensions (W x H)	Voltage	Watts	Amps	Plugs	Approx. Ship Weight	List Price
IHDCH-28	28 1/4" x 28 3/4" x 30 1/4"	22" x 20 5/8"	208 240	3090	14.9 or 12.9	NEMA 6-20P	220 lbs.	<b>\$12490</b>
IHDCH-45	45" x 28 3/4" x 30 1/4"	18" x 20 7/8"	208 240	3090	14.9 or 12.9	NEMA 6-20P	270 lbs.	<b>13343</b>

**All Intelligent Heated Display Cabinet Models Feature:**

**Models Shipped With: IHDCH-28:** Stainless Steel unit with single french door, touchscreen controller, a lighted Power On/Off (I/O) switch, an air heating/circulation system, a humidity system, a USB port and LED display lights.

**IHDCH-45:** Stainless Steel unit with sliding glass doors, touchscreen controller, a lighted Power On/Off (I/O) switch, an air heating/circulation system, a humidity system, a USB port and LED display lights.

**Cord Location:** Server side, lower left corner.

**OPTIONS AND ACCESSORIES – PAGE 190**  
**WATER QUALITY REQUIREMENTS – PAGE 247**

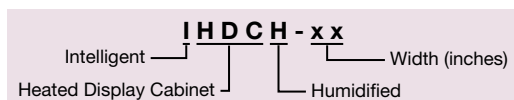

**On all Intelligent Heated Display Cabinet Models customers must purchase arms and shelves separately to their own specifications.**

**Below are the options available to combine the shelves and arms**

**IHDCH-28**

- 4 Arms**
- 3 Shelves**
- 1 Shelf with 1 Pizza Arm**
- 1 Shelf with 2 Pizza Arms**
- 2 Shelves with 1 Pizza Arm**

**IHDCH-45**

- 6 Arms**
- 3 Slanted Shelves**
- 1 Shelf with 2 Pizza Arms**
- 1 Shelf with 4 Pizza Arms**
- 2 Shelves with 2 Pizza Arms**



IHDC-45 shown with accessory arms, accessory risers and sign holders

**OPTIONS** (available at time of purchase only)

**Designer Colors – Non-standard colors are non-returnable – Stainless Steel Standard –**

IHDC-BK	Unit in <i>Designer Black</i> in lieu of Stainless Steel unit	<b>\$ 506</b>
IHDCHBASE-BK-28	Inside base in <i>Designer Black</i> in lieu of Stainless Steel base for IHDC-28	<b>36</b>
FRTDOOR-28	Front, swing out door for IHDC-28, left-hand hinge standard, matches unit color (adds 2" to depth)	<b>946</b>
IHDCHBASE-BK-45	Inside base in <i>Designer Black</i> in lieu of Stainless Steel base for IHDC-45	<b>36</b>
FRFRDOOR-45	Front, self-closing French doors for IHDC-45, matches unit color (adds 2" to depth)	<b>1792</b>

**ACCESSORIES** (available for purchase at any time)

ADJARM-SS	Pizza Arm in Stainless Steel	<b>each \$ 195</b>
ADJARM-BK	Pizza Arm in <i>Designer Black</i>	<b>each 236</b>
SHELF-SS-28	Shelf in Stainless Steel for IHDC-28	<b>each 263</b>
SHELF-BK-28	Shelf in <i>Designer Black</i> for IHDC-28	<b>each 263</b>
SHELF-SS-45	Shelf in Stainless Steel for IHDC-45	<b>each 387</b>
SHELF-BK-45	Shelf in <i>Designer Black</i> for IHDC-45	<b>each 671</b>
RISER12-SS	12" diameter x 1½" H Riser in Stainless Steel	<b>30</b>
RISER12-BK	12" diameter x 1½" H Riser in <i>Designer Black</i>	<b>43</b>
DOORLOCKIHDC	Front Door lock for IHDC-28 only	<b>27</b>
RO KIT	Reverse Osmosis System with storage tank	<b>1779</b>
REGKIT	Water Pressure Regulator Kit (regulator, gauge and shut-off valve)	<b>410</b>

**SIGN HOLDERS** (signs not included) – recommended sign size: 2" x 3.5" –

SGNHOLD-BASE-SS	Sits on base of unit in Stainless Steel	<b>each \$19</b>
SGNHOLD-BASE-BK	Sits on base of unit in <i>Designer Black</i>	<b>each 35</b>
SGNHOLD-LARM-SS	Customer left-hand side in Stainless Steel (clips onto Arm)	<b>each 21</b>
SGNHOLD-LARM-BK	Customer left-hand side in <i>Designer Black</i> (clips onto Arm)	<b>each 41</b>
SGNHOLD-RARM-SS	Customer right-hand side in Stainless Steel (clips onto Arm)	<b>each 21</b>
SGNHOLD-RARM-BK	Customer right-hand side in <i>Designer Black</i> (clips onto Arm)	<b>each 41</b>

**FOOD PANS AND TRIVETS – PAGE 245**  
**COLORS AND FINISHES – INSIDE BACK COVER**

## Flav-R-Savor® Humidified Large Capacity Display Cabinets

Hatco Large Capacity Holding Cabinets hold more product at proper serving temperatures than standard size models. This allows for food to be prepared in advance of peak serving periods, while placing product in full-view cabinets to increase impulse sales.

- Full-view display with tempered glass sides and LED lighting to illuminate holding area
- Optional self-closing sliding doors for self-serve applications
- Optional self-closing French doors,
- Optional cool LED lighting and 4" adjustable legs available
- Multi-purpose display racks included



**WFST-2X** with 4-shelf multi-purpose rack, optional *Designer Warm Red*, self-closing sliding doors and accessory food pans, and 4" legs



**WFST-1X** with 4-shelf multi-purpose rack. Decals and pans not included

### HUMIDIFIED LARGE CAPACITY CABINETS

Model	Description	Dimensions W x D x H	Voltage	Watts	Amps	Plugs*	Approx. Ship Weight	List Price
<b>WFST-1X</b>	2 Doors w/4-Shelf Rack	32 $\frac{1}{8}$ " x 25 $\frac{1}{4}$ " x 32 $\frac{3}{4}$ "	120 or 120/208-240	1715 or 2315	14.3	NEMA 5-15P	182 lbs.	<b>\$ 9415</b>
<b>WFST-2X</b>	4 Doors w/4-Shelf Rack	32 $\frac{1}{8}$ " x 27 $\frac{5}{8}$ " x 32 $\frac{3}{4}$ "	120 or 120/208-240	1715 or 2315	14.3	NEMA 5-15P	188 lbs.	<b>10062</b>

\* Canadian models use NEMA 5-20P.

#### All Humidified Capacity Cabinet Models Feature:

Cabinet Opening Dimensions: 28"W x 21 $\frac{1}{8}$ "H.  
Available Shelf Space: 26 $\frac{1}{4}$ "W x 19 $\frac{3}{4}$ "D. Holds one full-size sheet pan per shelf.  
Water Tank Capacity for Humidity System:  $\frac{3}{4}$  gallon.  
Cord Location: Server side, left-hand side panel, lower right corner.

### WATER QUALITY REQUIREMENTS – PAGE 247

Holding & Display Cabinets

#### OPTIONS (available at time of purchase only)

**Designer Colors – Non-standard colors are non-returnable – Clear Anodized Aluminum Standard –**

<b>RED</b>	Warm Red	<b>\$506</b>
<b>BLACK</b>	Black	<b>506</b>
<b>GRAY</b>	Gray Granite	<b>506</b>
<b>WHITE</b>	White Granite	<b>506</b>
<b>NAVY</b>	Navy Blue	<b>506</b>
<b>GREEN</b>	Hunter Green	<b>506</b>
<b>COPPER</b>	Antique Copper	<b>506</b>
<b>1SLIDE-DR</b>	Self-closing Sliding Doors in lieu of standard Hinged Doors (WFST-2X only)	<b>\$508</b>
<b>FRSELFCL</b>	Self-Closing French Doors	<b>per side 156</b>
<b>WFST-TTC</b>	Temperature Control Timer - 6 channel control touchscreen display	<b>602</b>
<b>LED-NW18</b>	Neutral White (cool) LED lighting (in lieu of standard Warm White)	<b>No Charge</b>

#### ACCESSORIES (available for purchase at any time)

<b>FSTCR-LEG</b>	4" Adjustable Legs	<b>\$86</b>
------------------	--------------------	-------------

### FOOD PANS AND TRIVETS – PAGE 245

### COLORS AND FINISHES – INSIDE BACK COVER

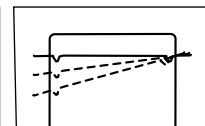
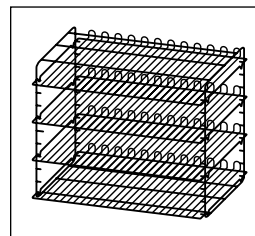

**WFST 4-Shelf Multi-Purpose Rack**  
Adjustable Shelves in 2" increments





# Flav-R-Savor® Non-Humidified Large Capacity Display Cabinets

When capacity is an issue, Hatco's Large Capacity Holding Cabinet is perfect for wrapped or bagged product. Designed to hold prepared foods for prolonged periods of time, while maintaining that "just-made" quality, allows for advanced preparation of peak serving periods.

- Countertop cabinets with self-closing French-style glass doors
- Standard sign holders on all four sides of the cabinet (signs not included)
- Full-view display with tempered glass sides and incandescent lights to illuminate holding area
- Multi-purpose display rack included
- Perfect for large quantities of wrapped or boxed food
- Holds two standard sheet pans side-by-side on three shelves for increased product visibility and easy accessibility

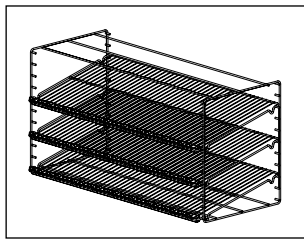

**LFST 3-Shelf Multi-Purpose Rack** with adjustable shelves in 2" increments

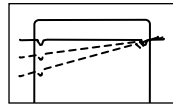

**LFST-48-2X** with 3-shelf multi-purpose rack, sign holders (signs not included) and optional *Designer Warm Red*

Holding & Display Cabinets

## NON-HUMIDIFIED LARGE CAPACITY CABINETS

Model <sup>Ⓜ</sup>	Bulbs	Description	Dimensions W x D x H	Plug	Approx. Ship Weight	List Price
<b>LFST-48-1X</b>	6	Front Glass, Back French Doors	48 <sup>7</sup> / <sub>8</sub> " x 25 <sup>3</sup> / <sub>8</sub> " x 30"	NEMA L14-20P	222 lbs.	<b>\$12459</b>
<b>LFST-48-2X</b>	6	Front and Back French Doors	48 <sup>7</sup> / <sub>8</sub> " x 27 <sup>1</sup> / <sub>8</sub> " x 30"	NEMA L14-20P	230 lbs.	<b>13161</b>

<sup>Ⓜ</sup> When no color is specified, unit will be Black.

### All Non-Humidified Large Capacity Cabinet Models Feature:

**Voltage:** 120/208-240, 2150 watts, 14.6 amps.

**Cabinet Opening Dimensions:** 44"W x 22"H.

**Available Shelf Space:** 41<sup>3</sup>/<sub>4</sub>"W x 17"D. Holds three, half-size sheet pans per shelf.

**Cord Location:** Server side, left-hand side panel, lower right corner.

## OPTIONS (available at time of purchase only)

### Designer Colors – Non-standard colors are non-returnable – Black Standard –

<b>CLEAR</b>	Clear Anodized Aluminum	<b>No Charge</b>
<b>RED</b>	Warm Red	<b>No Charge</b>
<b>GRAY</b>	Gray Granite	<b>No Charge</b>
<b>WHITE</b>	White Granite	<b>No Charge</b>
<b>NAVY</b>	Navy Blue	<b>No Charge</b>
<b>GREEN</b>	Hunter Green	<b>No Charge</b>
<b>COPPER</b>	Antique Copper	<b>No Charge</b>
<b>HAL</b>	60 Watt Halogen Bulb in lieu of Standard Display Light	<b>each \$69</b>

### FOOD PANS AND TRIVETS – PAGE 245

### COLORS AND FINISHES – INSIDE BACK COVER

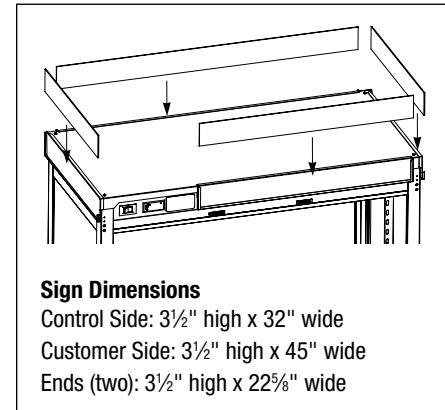

### Sign Dimensions

Control Side: 3<sup>1</sup>/<sub>2</sub>" high x 32" wide

Customer Side: 3<sup>1</sup>/<sub>2</sub>" high x 45" wide

Ends (two): 3<sup>1</sup>/<sub>2</sub>" high x 22<sup>5</sup>/<sub>8</sub>" wide

**LFST Cabinet** comes with sign holders attached on all four sides, with clear plastic inserts (signs not included)

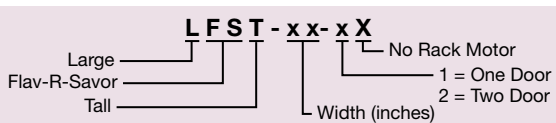



## Non-Humidified Mini Display Warmers

The Hatco Mini Display Warmer is perfect for cookies, pastries, wrapped or boxed sandwiches or any other product that does not require humidity. Hot air circulates throughout the entire cabinet, keeping food at safe serving temperatures. The small footprint takes up little of your valuable counterspace while merchandising your breakfast, lunch or dinner offerings.

- Magnetically adjustable shelves allow horizontal or slanted displays
- Tempered glass sides and incandescent light
- Available as a 1- or 2-door pass-through model
- Doors may be field converted to any side
- Optional black hood with backlit graphic sign cutout that can be rotated in field to face any side (sign included)

**MDW-1X** with standard *Designer Black* and optional Hood with backlit sign cutout on one side (sign included)



Magnetically adjustable shelves are easy and offer quick adjustability for different food products

### MINI DISPLAY WARMERS – NON-HUMIDIFIED

Model	Description	Dimensions W x D x H	Voltage	Watts	Amps	Plug	Approx. Ship Weight	List Price
<b>MDW-1X</b>	1 Door w/3 Shelves	15¾" x 17" x 25½"	120	470	3.9	NEMA 5-15	46 lbs.	<b>\$2815</b>
<b>MDW-2X</b>	2 Doors w/3 Shelves	15¾" x 18¾" x 25½"	120	470	3.9	NEMA 5-15	53 lbs.	<b>2926</b>

**All Mini Display Warmer Models Feature:**

Cabinet Opening Dimensions: 12½"W x 15¾"H.

Door Hinges: **Control Side:** Left-hand side.

**Customer Side (two-door models only):** Right-hand side.

Cord Location: Server side, lower right corner.

Holding & Display Cabinets

### OPTIONS (available at time of purchase only)

**Designer Color for Posts, Base, and Top Trim – Non-standard colors are non-returnable – Black Standard –**

<b>RED</b>	Warm Red	<b>No Charge</b>
<b>GRAY</b>	Gray Granite	<b>No Charge</b>
<b>WHITE</b>	White Granite	<b>No Charge</b>
<b>NAVY</b>	Navy Blue	<b>No Charge</b>
<b>GREEN</b>	Hunter Green	<b>No Charge</b>
<b>COPPER</b>	Antique Copper	<b>No Charge</b>
<b>BCKLIT-MDW</b>	Hood with Backlit Sign cut out on one side - Black only (sign included)	<b>\$144</b>

### COLORS AND FINISHES – INSIDE BACK COVER

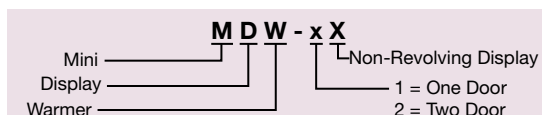



## Non-Humidified Macho Nacho® Chip Warmers

Keep your nacho chips hot, fresh and crisp with Hatco's Macho Nacho® Chip Warmer. This highly-visible heated merchandiser circulates air to prevent the loss of natural oils, eliminating the need to frequently replace stale chips.

- Keeps chips hot, fresh and crisp longer, reducing refill time and minimizing waste
- Specialty cabinets to hold and/or merchandise bulk nacho chips
- Special ductwork forces dry heat through chips from the bottom up
- Special two-door access for easy loading and serving
- 25 lb. or 40 lb. capacity
- Shatter-resistant incandescent lights illuminate the holding areas and emphasize the product



FDWD-1-MN



FST-1-MN shown in standard Bronze

Holding & Display Cabinets

### CHIP WARMERS – NON-HUMIDIFIED

Model	Dimensions W x D x H	Product Capacity	Voltage	Watts	Plug	Approx. Ship Weight	List Price
FDWD-1-MN	19 <sup>3</sup> / <sub>8</sub> " x 24" x 28 <sup>7</sup> / <sub>8</sub> "	25 lbs.	120	1080	NEMA 5-15P	101 lbs.	<b>\$4410</b>
FST-1-MN	22 <sup>7</sup> / <sub>8</sub> " x 27" x 32 <sup>1</sup> / <sub>2</sub> "	40 lbs.	120	1245	NEMA 5-15P	132 lbs.	<b>6164</b>

#### All Chip Warmer Models Feature:

Cabinet Opening: FDWD-1-MN: Upper Door: 16<sup>3</sup>/<sub>8</sub>"W x 9<sup>1</sup>/<sub>2</sub>"H.  
Lower Door: 16<sup>3</sup>/<sub>8</sub>"W x 9<sup>1</sup>/<sub>2</sub>"H.

FST-1-MN: Upper Door: 18<sup>5</sup>/<sub>8</sub>"W x 11<sup>1</sup>/<sub>4</sub>"H.  
Lower Door: 18<sup>5</sup>/<sub>8</sub>"W x 9<sup>1</sup>/<sub>2</sub>"H.

Decal Size: FDWD-1-MN: 16<sup>3</sup>/<sub>8</sub>"W x 5<sup>1</sup>/<sub>2</sub>"H.

FST-1-MN: 18<sup>5</sup>/<sub>8</sub>"W x 6"H.

Cord Location: Facing controls, left-hand side panel, lower right corner.

**x x x x - 1 - M N**

FDWD = 25 lbs. chip capacity  
FST = 40 lbs. chip capacity

— Macho Nacho Unit  
— Single Side Opening

## Flav-R-Savor® Tall Non-Humidified Holding Cabinets

Be prepared to serve ready-to-go pizzas with Hatco's Flav-R-Savor® Tall Dry Holding Cabinets. An eight-shelf rack with 5" centers will hold a maximum of 16 boxed (18" Sq x 2<sup>5</sup>/<sub>16</sub>" H maximum) or 8 bagged pizzas.

- Great for boxed or bagged carryout pizzas
- Tempered glass throughout for excellent visibility, improving product rotation
- Even, constant cabinet temperatures with no humidity
- Two, shatter-resistant, incandescent lights at the back top of the unit to illuminate product
- Units come with an eight-shelf rack, six of which are removable



**PFST-2X** with standard stainless steel 8-shelf rack



**PFST-1XB** with standard Glossy White 8-shelf rack

Holding & Display Cabinets

### TALL HOLDING CABINETS – NON-HUMIDIFIED

Model	Description	Dimensions W x D x H	Opening Dimensions W x H	Voltage	Watts	Plug*	Approx. Ship Weight	List Price
<b>Standard</b>								
<b>PFST-1X</b>	1 Door	22 <sup>7</sup> / <sub>8</sub> " x 25" x 57"	18 <sup>3</sup> / <sub>4</sub> " x 40 <sup>3</sup> / <sub>8</sub> "	120	1767	NEMA 5-15P	200 lbs.	<b>\$8040</b>
<b>PFST-2X</b>	2 Doors	22 <sup>7</sup> / <sub>8</sub> " x 27 <sup>1</sup> / <sub>4</sub> " x 57"	18 <sup>3</sup> / <sub>4</sub> " x 40 <sup>3</sup> / <sub>8</sub> "	120	1767	NEMA 5-15P	207 lbs.	<b>\$8462</b>
<b>With Base</b>								
<b>PFST-1XB</b>	1 Door	24 <sup>3</sup> / <sub>4</sub> " x 25 <sup>1</sup> / <sub>2</sub> " x 70"	18 <sup>3</sup> / <sub>4</sub> " x 40 <sup>3</sup> / <sub>8</sub> "	120	1767	NEMA 5-15P	258 lbs.	<b>\$8338</b>

\* Canadian models use NEMA 5-20P.

#### All Tall Dry Holding Cabinet Models Feature:

**Models Shipped with: PFST-1X, -2X:** Stainless Steel body, an eight-shelf rack with 6 removable shelves in standard stainless steel, new latching handle, 5" locking casters, cord and plug.

**PFST-1XB:** Solid back panel, stainless steel inside, (with painted Glossy Gray on the outside), an eight-shelf rack with 6 removable shelves in standard Smooth White, front and side sign holders painted Glossy Gray with flip-up side for access to controls (signs not included), 11" high Designer Black base, latching handle, 4" locking casters, cord and plug.

**Available Shelf Space:** 18" square x 4<sup>5</sup>/<sub>8</sub>" height.

**Cord Location:** Facing controls, left-hand side panel, bottom right corner.

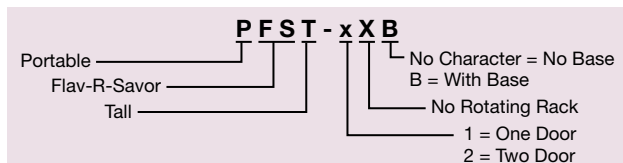

#### OPTIONS (available at time of purchase only)

**Designer Color – Non-standard colors are non-returnable –**  
**– Clear Anodized Aluminum Standard –**  
**BLACK** Black **\$506**

#### COLORS AND FINISHES – INSIDE BACK COVER



# Flav-R-Savor® Portable Holding Cabinets

Hatco's energy efficient Flav-R-Savor® Portable Holding Cabinets will keep prepared foods at optimum serving temperatures for hours. The thermostatically-controlled heat and humidity allows food to be prepared in advance of peak serving periods.

- Allows you to hold product longer while saving you money through increased energy efficiencies
- Electronic control with digital read out, temperature range of 80°- 200°F and humidity controller
- The lower temperature range of 80°-100°F can be used for proofing all types of breads
- All stainless steel interior
- No heating element in direct contact with water makes the unit easier to clean
- Accommodates Gastronorm pans
- Electrical components, controls and digital temperature readout are located at the top for easy access
- Stacking kit available
- Doors are field convertible from left to right



FSHC-7W1-EE shown in Designer Black, with optional bumper kit, and right-hand hinged door



## PORTABLE HOLDING CABINETS

Model	Description	Dimensions			Voltage	Hz	Watts	Amps	Plug	Approx. Ship Weight	List Price
		W x D x H									
FSHC-5W1-EE	Single Door	26 1/8" x 31 1/4" x 36"	120	60	1118	9.3	NEMA 5-15P	250 lbs.	\$8970		
FSHC-7W1-EE	Single Door	26 1/8" x 31 1/4" x 39"	120	60	1118	9.3	NEMA 5-15P	222 lbs.	9435		
FSHC-7W2-EE	2-Door Pass-Through	26 1/8" x 34 3/4" x 39"	120	60	1118	9.3	NEMA 5-15P	232 lbs.	9970		

### All Portable Holding Cabinet Models Feature:

Interior Cabinet Capacity: 20 7/8"W x 26 7/8"D.

Top Surface Dimensions: 25 3/4"W x 28 1/2"D.

Models Shipped with: 6' cord and plug, 4" diameter casters (with 5/8" clearance), stainless steel heavy-duty door with left-hand door hinge, and adjustable rack slides (seven for the -7WX-EE units, and five for the -5W1-EE unit).

Pan Capacity: -5W1-EE: 10 full sized sheet pans or 2/1 Gastronorm pans on 1 3/8" spacing, 5 full sized sheet pans or 2/1 Gastronorm pans on 3/4" spacing, 10 full sized hotel pans or 1/1 Gastronorm pans on 1 3/8" spacing.  
-7Wx-EE: 14 full sized sheet pans<sup>□</sup> or 2/1 Gastronorm pans on 1 3/8" spacing, 7 full sized sheet pans or 2/1 Gastronorm pans on 2 3/4" spacing, 14 hotel sized pans or 1/1 Gastronorm pans on 1 3/8" spacing.

Water Tank Capacity for Humidity System: 1 gallon.

Cord Location: Recessed, back of unit, upper right side.

<sup>□</sup> With purchase of extra pan slides.

## WATER QUALITY REQUIREMENTS – PAGE 247



FSHC-7W1-EE & FSHC-7W2-EE (120V models only) NOTE: Units equipped with a heavy-duty glass door(s) are not ENERGY STAR qualified

## OPTIONS (available at time of purchase only)

Colors (Side Panels) – Non-standard colors are non-returnable – Black standard –

SS Stainless Steel \$243

Colors (Top) – Non-standard colors are non-returnable – Black standard –

SS Stainless Steel \$243

EE-GLASS Glass Door (in lieu of stainless steel door) (is not Energy Star qualified) \$302

EE-LPCAST Low profile casters (FSHC-5W1-EE model only) (deduct 2 1/4" from height) No Charge

EE-PLATFORM Platform for mounting directly on a counter (deduct 4 1/8" from height) (in lieu of casters) No Charge

EE-STACK-BLK Designer Black powdercoated stacking hardware mounted to bottom of cabinet for two FSHC-7W1 or two FSHC-5W1 units in lieu of casters (cannot have legs on lower unit) No Charge

EE-STACK-SS Stainless steel stacking hardware mounted to bottom of cabinet for two FSHC-7W1 or two FSHC-5W1 units in lieu of casters (cannot have legs on lower unit) No Charge

EE-BUMPER Bumper Hardware (only for use with standard casters) (add 1/8" to height) 581

EE-4LEGS 4" legs (in lieu of casters, deduct 1/2" from height) No Charge

EE-6LEGS 6" legs (in lieu of casters, add 1 3/4" to height) No Charge

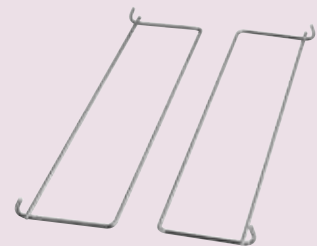

EE-1-SLIDE Accessory

## ACCESSORIES (available for purchase at any time)

EE-1-SLIDE Extra Pan Slides pair \$112

## FOOD PANS AND TRIVETS – PAGE 245

## COLORS AND FINISHES – INSIDE BACK COVER





## Flav-R-Savor® Low Profile, Humidified, Portable Holding Cabinets

Prepare food in advance of peak serving periods and safely hold it at optimum serving temperatures with the Flav-R-Savor® Portable Holding Cabinet. Thermostatically-controlled heat and humidity allows you to hold product for hours.

- Thermostatically-controlled heat and humidity holds hot food at optimum serving temperatures longer
- Allows preparation of food in advance of peak serving periods
- Accommodates Gastronorm pans
- Electrical components, controls, water reservoir and digital temperature readout are located at the top for easy access
- Reduced height – less than 30" high, and wider footprint for increased capacity
- Insulated side walls, field reversible glass doors, large swivel casters with wheel locks and 6' recessed cord and plug are standard
- Stacking kit available



FSHC-6W1 with accessory food pans

### LOW PROFILE HOLDING CABINETS – HUMIDIFIED

Model	Description	Dimensions (W x D x H) <i>Height includes standard casters</i>	Cabinet Opening (W x H)	Top Surface Dimensions (W x D)	Plug	Approx. Ship Weight	List Price
FSHC-6W1	1 Door	25½" x 29¾" x 32⅞"	21½" x 19"	25⅝" x 25⅞"	NEMA 5-15P	167 lbs.	<b>\$7586</b>
FSHC-6W2	2 Doors	25½" x 32" x 32⅞"	21½" x 19"	25⅝" x 25⅞"	NEMA 5-15P	180 lbs.	<b>8118</b>

† FSHC-6W2 is a two-door pass-through single cabinet, not two units stacked.

#### All Low Profile Holding Cabinet Models Feature:

**Voltage:** 120, 60 Hz, 1697 watts, 14.1 amps. NEMA 5-15P (NEMA 5-20P Canada).

**Models Shipped with:** 6' cord and plug, 4" diameter casters (with 5/8" clearance), six sets of adjustable angle slides.

**Pan Capacity:** Six 18"W x 26"D sheet pans or six 2/1 Gastronorm pans on 3" centers, eleven 18"W x 26"D sheet pans<sup>‡</sup>, eleven 2/1 Gastronorm pans on 1½" centers<sup>‡</sup>, or twelve 20"W x 12"D x 2½"H hotel pans<sup>‡</sup>.

**Water Tank Capacity for Humidity System:** ¾ gallon.

**Cord Location:** Recessed, back of unit, upper right side.

<sup>‡</sup>With purchase of extra pan slides.

### WATER QUALITY REQUIREMENTS – PAGE 247

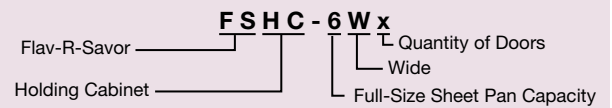

Holding & Display Cabinets

### OPTIONS (available at time of purchase only)

**Colors (Side Panels) – Non-standard colors are non-returnable – Silver Gray Standard –**

<b>BLACK</b>	Designer Black	<b>\$243</b>
<b>SS</b>	Stainless Steel	<b>243</b>

**Colors (Top) – Non-standard colors are non-returnable – Silver Gray Standard –**

<b>BLACK</b>	Designer Black	<b>\$243</b>
<b>SS</b>	Stainless Steel	<b>243</b>

**6W-SS-DR** Stainless Steel Door in lieu of Glass Door **\$ 105**

**HD-SS-DR** Heavy-Duty Stainless Steel Door with Positive Latch Handle **433**

**6W1-LPCAST** 2" Low Profile Locking Casters in lieu of standard Casters (2" diameter with 3" clearance - Overall height is 29¾") **No Charge**

**6W1-STACK** Stacking Hardware mounted to top of Cabinet for two FSHC-6W1 Units in lieu of Casters (Silver Gray) **100**

**CORDWIND** Bracket for holding Cord during transport **40**

### ACCESSORIES (available for purchase at any time)

**6W1-SLIDE** Extra Pan Slides **pair \$112**

### FOOD PANS AND TRIVETS – PAGE 245

### COLORS AND FINISHES – INSIDE BACK COVER

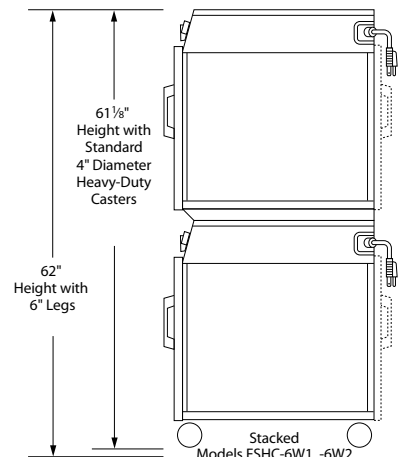
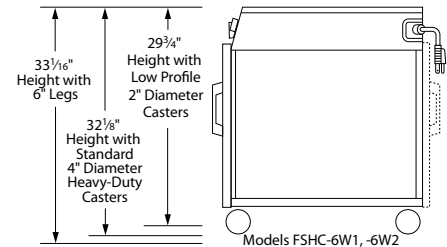

## Flav-R-Savor® Humidified Portable Holding Cabinets

Prepare food in advance of peak serving periods and safely hold it at optimum serving temperatures with the Flav-R-Savor® Portable Holding Cabinet. Thermostatically-controlled heat and humidity allows you to hold product for hours.

- Thermostatically-controlled heat and humidity holds hot food at optimum serving temperatures longer
- Allows preparation of food in advance of peak serving periods
- Accommodates Gastronorm pans
- Electrical components, controls, water reservoir and digital temperature readout are located at the top for easy access
- Insulated side walls, field reversible glass doors, large swivel casters with wheel locks and 6" recessed cord and plug are standard
- Stacking kit available



**FSHC-7-1** with standard 4" casters and accessory food pans

### PORTABLE HOLDING CABINETS – HUMIDIFIED

Model	Description	Dimensions (W x D x H) <i>Height includes standard casters</i>	Cabinet Opening (W x H)	Top Surface Dimensions (W x D)	Plug	Approx. Ship Weight	List Price
<b>FSHC-7-1</b>	1 Door	22 <sup>3</sup> / <sub>4</sub> " x 29 <sup>5</sup> / <sub>8</sub> " x 35 <sup>1</sup> / <sub>8</sub> "	18 <sup>1</sup> / <sub>2</sub> " x 22"	22 <sup>5</sup> / <sub>8</sub> "W x 25 <sup>7</sup> / <sub>8</sub> "	NEMA 5-15P	175 lbs.	<b>\$7655</b>
<b>FSHC-7-2</b>	2 Doors	22 <sup>3</sup> / <sub>4</sub> " x 32" x 35 <sup>1</sup> / <sub>8</sub> "	18 <sup>1</sup> / <sub>2</sub> " x 22"	22 <sup>5</sup> / <sub>8</sub> "W x 25 <sup>7</sup> / <sub>8</sub> "	NEMA 5-15P	180 lbs.	<b>8192</b>

⚠ FSHC-7-2 is a two-door pass-through single cabinet, not two units stacked.

#### All Portable Holding Cabinet Models Feature:

**Voltage:** 120, 60 Hz, 1697 watts, 14.1 amps, NEMA 5-15P Canada (NEMA 5-20P Canada).

**Models Shipped with:** 6' cord and plug, 4" diameter casters (with 5/8" clearance), seven sets of adjustable angle slides for 18" x 26" pans or 12" x 20" pans.

**Pan Capacity:** Seven 18" x 26" sheet pans on 3" centers, seven 20" x 12" x 2 1/2" hotel pans or seven 1/1 Gastronorm pans.

**Water Tank Capacity for Humidity System:** 3/4 gallon.

**Cord Location:** Recessed, back of unit, upper right side.

### WATER QUALITY REQUIREMENTS – PAGE 247

#### OPTIONS (available at time of purchase only)

**Colors (Side Panels) – Non-standard colors are non-returnable – Silver Gray Standard –**

<b>BLACK</b>	Designer Black	<b>\$243</b>
<b>SS</b>	Stainless Steel	<b>243</b>

**Colors (Top) – Non-standard colors are non-returnable – Silver Gray Standard –**

<b>BLACK</b>	Designer Black	<b>\$243</b>
<b>SS</b>	Stainless Steel	<b>243</b>

**SS-DR** Stainless Steel Door in lieu of Glass Door **\$ 105**

**HD-SS-DR** Heavy-Duty Stainless Steel Door with Positive Latch Handle **433**

**LWALARM** Audible Low-Water Alarm **98**

**LPCAST** 2" Low Profile Casters in lieu of Standard Casters (2" diameter with 3" clearance - Overall Height 32<sup>3</sup>/<sub>4</sub>") **40**

**4LEGS** 4" Adjustable Legs in lieu of standard Casters **No Charge**

**6SS** 6" Stainless Steel Legs in lieu of standard Casters **No Charge**

**7-1-STACK** Stacking Hardware mounted to top of cabinet for two FSHC-7-1 units in lieu of Casters (Silver Gray) **139**

**CORDWIND** Bracket for holding cord during transport **40**

#### ACCESSORIES (available for purchase at any time)

**SLIDEWIRE** Wire Shelf **per shelf \$147**

### FOOD PANS AND TRIVETS – PAGE 245

### COLORS AND FINISHES – INSIDE BACK COVER

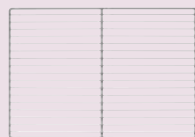

**SLIDEWIRE**  
Accessory

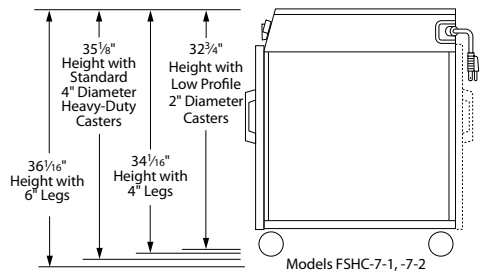
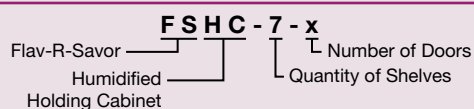

Models FSHC-7-1, -7-2

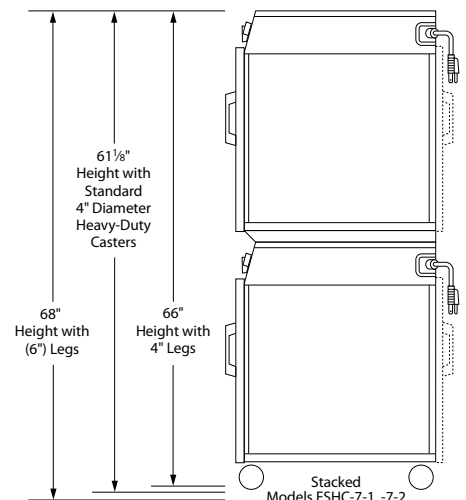

Stacked Models FSHC-7-1, -7-2

## Flav-R-Savor® Tall Humidified Holding Cabinets

The expanded capacity of Hatco's Tall Humidified Cabinets offers flexibility – giving customers more variety of menu items, and holding larger quantities of proven favorites ahead of peak serving periods. The universal slides of the FSHC-17W models will hold 17 sheet pans or 34 steam table pans. FSHC-12W models will hold 12 sheet pans and 24 steam table pans.

- Electronic controls with digital readout temperature range of 80°-200°F with precise heat and humidity settings assure uniform heating throughout the cabinet
- Using the lower temperature range of 80°-100°F allows perfect temperature for proofing all types of bread
- Lexan or stainless steel doors, full height, half height and pass-through available
- All Stainless Steel interior and exterior
- Fully insulated doors, sidewalls, base and top assist in heat retention and quick recovery
- Field reversible, right- or left-hand hinged doors with magnetic latch and heavy-duty plated hinges
- Fully welded tubular frame assures integrity of unit in any working environment



**FSHC-12W1**  
with optional  
Stainless Steel door



**FSHC-17W1**

Holding & Display Cabinets

### TALL HUMIDIFIED HOLDING CABINETS

Model*	Description	Dimensions W x D x H ‡	Voltage Single Phase	Watts	Amps	Plugs	Approx. Ship Weight	List Price
<b>FSHC-12W1</b>	Single Lexan® Door	26" x 34¾" x 57¾"	120 208-240	1650 1608-2133	13.8 7.7-8.9	NEMA 5-15P NEMA 6-15P	303 lbs.	<b>\$12187</b>
<b>FSHC-12W2</b>	2 Lexan® Doors – Pass-Through	26" x 35¾" x 57¾"	120 208-240	1650 1608-2133	13.8 7.7-8.9	NEMA 5-15P NEMA 6-15P	316 lbs.	<b>14696</b>
<b>FSHC-17W1</b>	Single Lexan® Door	26" x 34¾" x 73¾"	120 208-240	1650 1608-2133	13.8 7.7-8.9	NEMA 5-15P NEMA 6-15P	352 lbs.	<b>12382</b>
<b>FSHC-17W1D</b>	Single Opening w/ 2 Dutch Doors	26" x 34¾" x 73¾"	120 208-240	1650 1608-2133	13.8 7.7-8.9	NEMA 5-15P NEMA 6-15P	360 lbs.	<b>13322</b>
<b>FSHC-17W2</b>	2 Lexan® Doors – Pass-Through	26" x 35¾" x 73¾"	120 208-240	1650 1608-2133	13.8 7.7-8.9	NEMA 5-15P NEMA 6-15P	365 lbs.	<b>14802</b>
<b>FSHC-17W2D</b>	4 Dutch Doors – Pass-Through	26" x 35¾" x 73¾"	120 208-240	1650 1608-2133	13.8 7.7-8.9	NEMA 5-15P NEMA 6-15P	389 lbs.	<b>16294</b>

‡ Height includes standard casters.

\* 120V Canadian Models use NEMA 5-20P.

**All Tall Humidified Holding Cabinet Models Feature:**

Cabinet Opening Dimensions: **FSHC-12W:** 22"W x 43½"H.

**FSHC-17W:** 22"W x 59¾"H.

**Models Shipped with:** 10' cord and plug, 5" casters, universal slides for 18" x 26" pans or 12" x 20" pans.

**Pan Capacity – FSHC-12W:** 12-sheet pan capacity on 3" centers, adjustable on 1½" centers, with 12 universal pan slides designed to accommodate up to 12 sheet pans or up to 24 steam table pans.

**Pan Capacity – FSHC-17W:** 17-sheet pan capacity on 3" centers, adjustable on 1½" centers, with 17 universal pan slides designed to accommodate up to 17 sheet pans or up to 34 steam table pans.

**Water Reservoir Capacity for Humidity System:** 2 gallons.

**Cord Location:** Recessed, facing controls, right-hand side panel, lower right corner.

**OPTIONS AND ACCESSORIES – PAGE 200**  
**WATER QUALITY REQUIREMENTS – PAGE 247**

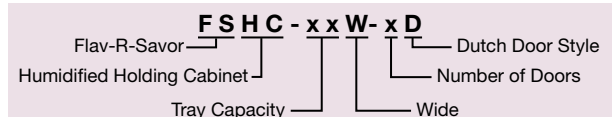



FSHC-17W1

**OPTIONS** (available at time of purchase only)

<b>DELUXE</b>	Deluxe Package (includes Flush Mount Handles and Full Perimeter Bumper)	<b>\$ 886</b>
<b>TRANS</b>	Transport Package (includes Stand-Off Handles, Full Perimeter Bumper, Heavy-duty 5" x 2" Casters (2 swivel with wheel locks and 2 rigid), and Flush Mount Transport Latch)	<b>1564</b>
<b>CORDWIND</b>	Bracket for holding cord during transport (only available with Transport Package option for FSHC-12W and FSHC-17 models)	<b>90</b>
<b>12W-SS-DOOR</b>	Stainless Steel Door in lieu of Lexan® Door	<b>No Charge</b>
<b>17W-SS-DOOR</b>	Stainless Steel Door in lieu of Lexan® Door	<b>No Charge</b>
<b>17WD-SS-DOOR</b>	Stainless Steel Dutch Doors in lieu of Lexan® Dutch Doors (FSHC-17W models only)	<b>No Charge</b>

**ACCESSORIES** (available for purchase at any time)

<b>17W-SLIDE</b>	Extra Pan Slides (FSHC-12W and FSHC-17W)	<b>pair \$161</b>
------------------	--	-------------------

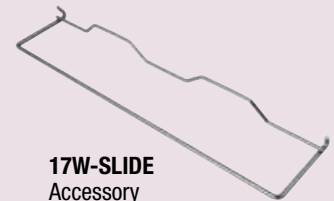

**FOOD PANS AND TRIVETS – PAGE 245**



## Flav-R-Savor® Heated Air Curtain Cabinets

The patented Flav-R-Savor® Heated Air Curtain Cabinet effectively and safely holds hot food hot without the use of doors, allowing immediate access to product. Warm air at the front of the cabinet is forced downward, through the ducts above the opening, forming a “curtain” of heated air. A portion of the heated air is drawn toward the rear of the cabinet, warming each pan.



**FS2HAC-15** with 1/3 size food pans (pans not included)

- Perfect for holding wrapped or sealed product like tortillas, burritos and ribs, as well as product on sheet pans like biscuits, hamburger patties and baked potatoes or fried foods in pans
- Available in 2-pan and 3-pan models, single opening or pass-through, with or without humidity
- The FS2HAC-15 holds 6, 1/3 size pans (pans not included)
- The 2-pan pass-through accommodates two full-size sheet pans or four half-size sheet pans, and the 4-pan unit accommodates four full-size sheet pans or eight half-size sheet pans
- FS2HAC-15 comes standard with a pan rack, removeable crumb tray, USB port and a touch screen control with temperature and timer display, and a 6' cord and plug



**FSHACH-2** with accessory food pans



**FS2HAC-2PT** with accessory food pans

### HEATED AIR CURTAIN CABINETS

Model	Description	Dimensions (W x D x H)	Cabinet Opening Dimensions (W x H)	Voltage	Watts	Amps	Plugs	Approx. Ship Weight	List Price
<b>FSHAC-2</b> †	2-Tier Warmer	20 <sup>7</sup> / <sub>8</sub> " x 22 <sup>7</sup> / <sub>8</sub> " x 18 <sup>1</sup> / <sub>8</sub> "	18 <sup>1</sup> / <sub>4</sub> " x 9 <sup>1</sup> / <sub>8</sub> "	120	1850	15.4	NEMA 5-20P	102 lbs.	<b>\$ 6209</b>
<b>FSHAC-2</b> ‡	2-Tier Warmer	20 <sup>1</sup> / <sub>8</sub> " x 22 <sup>7</sup> / <sub>8</sub> " x 18 <sup>1</sup> / <sub>8</sub> "	18 <sup>1</sup> / <sub>4</sub> " x 9 <sup>1</sup> / <sub>8</sub> "	120/208	1877	9.0	NEMA L14-20P	102 lbs.	<b>6209</b>
<b>FSHAC-3</b> †	3-Tier Warmer	20 <sup>7</sup> / <sub>8</sub> " x 22 <sup>7</sup> / <sub>8</sub> " x 30 <sup>1</sup> / <sub>2</sub> "	18 <sup>1</sup> / <sub>4</sub> " x 18 <sup>1</sup> / <sub>8</sub> "	120/208	1877	9.0	NEMA L14-20P	105 lbs.	<b>6483</b>
<b>FS2HAC-15</b>	Open Cavity Warmer	15 <sup>1</sup> / <sub>2</sub> " x 21 <sup>1</sup> / <sub>4</sub> " x 21 <sup>3</sup> / <sub>4</sub> "	14 <sup>3</sup> / <sub>4</sub> " x 13"	120	1105	9.2	NEMA 5-15P*	83 lbs.	<b>5787</b>
<b>FS2HAC-2PT</b> †	2-Tier Pass-Through	24 <sup>1</sup> / <sub>8</sub> " x 39 <sup>1</sup> / <sub>8</sub> " x 18 <sup>1</sup> / <sub>2</sub> "	18 <sup>1</sup> / <sub>16</sub> " x 8 <sup>1</sup> / <sub>8</sub> "	120/208 or 120/240	2589	10.8	NEMA L14-20P	175 lbs.	<b>9452</b>
<b>FS2HAC-4PT</b> †	4-Tier Pass-Through	24 <sup>1</sup> / <sub>8</sub> " x 39 <sup>1</sup> / <sub>8</sub> " x 26 <sup>1</sup> / <sub>2</sub> "	18 <sup>1</sup> / <sub>4</sub> " x 16 <sup>1</sup> / <sub>8</sub> "	120/208 or 120/240	3389	14.2	NEMA L14-20P	211 lbs.	<b>10326</b>

† Height includes 4" legs.  
\* Canadian models use NEMA 6-15P.

#### All Heated Air Curtain Cabinet Models Feature:

**Cord Location:** FSHAC-2, -3: Top of unit towards the back, middle.  
FS2HAC-15: Top of unit towards the back, right side.  
FS2HAC-2PT, -4PT: Top of unit towards the back, left side.

### HEATED AIR CURTAIN CABINETS – HUMIDIFIED

Model	Description	Dimensions (W x D x H)	Cabinet Opening Dimensions (W x H)	Voltage	Watts	Amps	Plugs	Approx. Ship Weight	List Price
<b>FSHACH-2</b>	2-Tier Warmer	20 <sup>7</sup> / <sub>8</sub> " x 24 <sup>3</sup> / <sub>8</sub> " x 18 <sup>1</sup> / <sub>8</sub> "	18 <sup>1</sup> / <sub>4</sub> " x 9 <sup>1</sup> / <sub>8</sub> "	120/208	2950	14.2	NEMA L14-20P	100 lbs.	<b>\$ 7251</b>
<b>FSHACH-3</b> †	3-Tier Warmer	20 <sup>7</sup> / <sub>8</sub> " x 24 <sup>3</sup> / <sub>8</sub> " x 30 <sup>1</sup> / <sub>2</sub> "	18 <sup>1</sup> / <sub>4</sub> " x 18 <sup>1</sup> / <sub>8</sub> "	120/208	2950	14.2	NEMA L14-20P	100 lbs.	<b>7577</b>
<b>FSHACH-2PT</b> †	2-Tier Pass-Through	24 <sup>1</sup> / <sub>8</sub> " x 35 <sup>5</sup> / <sub>8</sub> " x 22"	18 <sup>1</sup> / <sub>4</sub> " x 9 <sup>1</sup> / <sub>4</sub> "	120/208	4952	23.8	NEMA L14-30P	150 lbs.	<b>10491</b>
<b>FSHACH-2PT</b> ‡	2-Tier Pass-Through	24 <sup>1</sup> / <sub>8</sub> " x 35 <sup>5</sup> / <sub>8</sub> " x 22"	18 <sup>1</sup> / <sub>4</sub> " x 9 <sup>1</sup> / <sub>4</sub> "	208	4952	23.8	NEMA L6-30P	150 lbs.	<b>10491</b>

† Height includes 4" legs.

#### All Humidified Heated Air Curtain Cabinet Models Feature:

**Models Shipped with:** Auto-fill water reservoir and water filter. 4" legs also come standard (excluding FSHACH-2).  
**Water Tank Capacity for Humidity System:** FSHACH-2, -3: 2<sup>1</sup>/<sub>4</sub> gallons.  
FSHACH-2PT: 3 gallons.

**Cord Location:** FSHACH-2, -3: Top of unit towards the back, middle.  
FSHACH-2PT: Top of unit towards the back, left side.

### FOOD PANS AND TRIVETS – PAGE 245

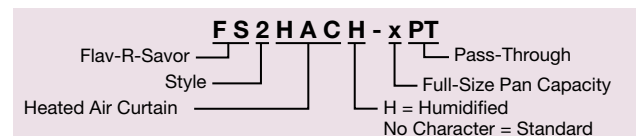
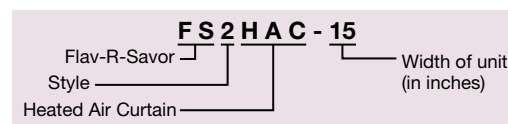

# Toasters

*Cafeterias • Buffets • Supermarkets & Delis  
Restaurants & Cafés • Clubs & Bars • Catering*



**ITQ-1750-2C** pg. 203



**TPT-120** pg. 204



**TQ3-20H** in standard *Designer Black* pg. 205



**TQ3-400** in standard *Designer Black* pg. 205



**TQ-400** pg. 206



**TQ-1800** pg. 206



**TK-100** pg. 208

## Intelligent Toast-Qwik®

Hatco's Intelligent Toast-Qwik® allows the operator to toast multiple products at the touch of the button, changing easily from bagels to croissants to Texas toast to hash browns, as well as melting cheese and finishing smaller food products. The unit can easily take the place of the current toasting platform and add versatility and future menu expansion, along with energy efficiency and cost savings.

- The conveyor toaster can operate in three different modes:
  - ~ Continuous Through Put
  - ~ In and Reverses Out Mode
  - ~ In, Pause, then Continues Through
- USB port located on the front allows for easy transfer of information, such as program changes and product usage information
- The ability to program up to twenty product settings
- Hatco's patented ColorGuard Sensing System monitors and adjusts conveyor

speed and temperature during high usage periods to ensure toast color uniformity

- Using Hatco's Spot-On® Technology, the toaster senses when product is placed on the conveyor and activates the unit
- Easy to clean, with removable crumb tray and collector ramp. There is minimal operator maintenance required, with self-cleaning elements and no maintenance motor and conveyor drives



ITQ-875-1C



ITQ-1000-1C



ITQ-1750-2C

### HORIZONTAL CONVEYOR TOASTERS

Model	Voltage	Dimensions W x D x H	Watts	Amps	Capacity/ Minute <sup>□</sup>	Plug	Approx. Ship Weight	List Price
ITQ-875-1C	208	14 <sup>5</sup> / <sub>8</sub> " x 28 <sup>3</sup> / <sub>4</sub> " x 16 <sup>5</sup> / <sub>8</sub> "	2700	13.0	15	NEMA 6-20P	86 lbs.	<b>\$6939</b>
ITQ-875-1C	240	14 <sup>5</sup> / <sub>8</sub> " x 28 <sup>3</sup> / <sub>4</sub> " x 16 <sup>5</sup> / <sub>8</sub> "	2700	11.3	15	NEMA 6-20P	86 lbs.	<b>6939</b>
ITQ-1000-1C <sup>✓</sup>	208-240	17 <sup>7</sup> / <sub>8</sub> " x 28 <sup>5</sup> / <sub>8</sub> " x 18"	3230-4300	15.5-17.9	17	NEMA 6-30P	89 lbs.	<b>7089</b>
ITQ-1750-2C	208	20 <sup>1</sup> / <sub>4</sub> " x 28 <sup>3</sup> / <sub>4</sub> " x 18 <sup>1</sup> / <sub>2</sub> "	4960	23.8	30	NEMA 6-30P	106 lbs.	<b>9451</b>
ITQ-1750-2C	240	20 <sup>1</sup> / <sub>4</sub> " x 28 <sup>3</sup> / <sub>4</sub> " x 18 <sup>1</sup> / <sub>2</sub> "	4960	20.7	30	NEMA 6-30P	106 lbs.	<b>9451</b>

□ Toasting capacity may vary by product. Toasting of coated products not recommended.

✓ Unit is designed to operate on supply voltages between 208V and 240V.

#### All Horizontal Conveyor Toaster Models Feature:

Opening Dimensions: ITQ-875-1C: 5<sup>5</sup>/<sub>8</sub>"W x 2<sup>1</sup>/<sub>2</sub>"H.

ITQ-1000-1C: 9<sup>5</sup>/<sub>8</sub>"W x 2"H.

ITQ-1750-2C: Two openings at 5<sup>5</sup>/<sub>8</sub>"W x 2<sup>1</sup>/<sub>4</sub>"H.

Cord Location: 6' cord – left center on back of unit.

#### OPTIONS (available at time of purchase only)

ITQ-L6-20	NEMA L6-20P Locking Cap in lieu of NEMA 6-20P	<b>\$208</b>
ITQ-L6-30	NEMA L6-30P Locking Cap in lieu of NEMA 6-30P	<b>46</b>



ITQ2C-PAD  
Accessory

#### ACCESSORIES (available for purchase at any time)

##### Paddle, with high temp, non-stick coating –

ITQ1C-PAD	9" wide Food Paddle for ITQ-1000-1C model only	<b>\$214</b>
ITQ2C-PAD	5.7" wide Food Paddle for ITQ-875-1C and ITQ-1750-2C models only	<b>164</b>
ITQ2CFEED175	Feed Ramp for ITQ-1750-2C only (sold as single ramp only)	<b>100</b>

ITQ - x x x x - x C

Intelligent Toast-Qwik  
Model Number  
1C = Single Conveyor  
2C = Dual Conveyor





## Pop-Up Toasters

Perfect for self-serve areas and light volume applications, the Hatco Pop-Up Toasters provide even golden toasting of a variety of bread products. The durable stainless steel housing contains four extra wide self-centering slots with individual toasting controls and removable crumb tray.

- Evenly toasts a variety of bread products including bagels, Texas toast, waffles and English muffins
- All models have four self-centering 1¼" wide slots
- A selector switch for single- or double-sided toasting (excluding TPT-120)
- Durable stainless steel construction
- Individual toasting controls
- Removable crumb trays for easy cleaning
- 6' cord with plug



TPT-120



TPT-208 Selector switch for single- or double-sided toasting (excluding TPT-120)

### POP-UP TOASTERS

Model	Dimensions W x D x H	Voltage	kW	Plug	Approx. Ship Weight	List Price
TPT-120*	13½" x 12¾" x 8½"	120	1.8	NEMA 5-15P	14 lbs.	\$536
TPT-208**	13¾" x 12¾" x 8½"	208	2.6	NEMA 6-15P	16 lbs.	967
TPT-240	13¾" x 12¾" x 8½"	240	2.6	NEMA 6-15P	16 lbs.	967

\* Canadian model is 1.4 kW.  
 \*\* Canadian model uses NEMA 6-20P.

#### All Pop-Up Toaster Models Feature:

Slot Opening: 1¼"W x 5½"D.

Cord Location: 6' cord – back of unit, lower center.

Pop-Up Toasters can be shipped Fed-Ex Ground or United Parcel Service.

#### TPT TOASTER AMP RATINGS

Model	120V/1 Ø Amps	208V/1 Ø Amps	240V/1 Ø Amps
TPT-120	15.0	–	–
TPT-120*	12.0	–	–
TPT-208	–	12.5	–
TPT-240	–	–	10.9

\* Canada only

#### OPTIONS (available at time of purchase only)

Designer Color – Non-standard colors are non-returnable – Stainless Steel Standard –		
BBLACK	Bold Black (TPT-120 only)	\$137
RRED	Radiant Red (TPT-120 only)	137

#### COLORS AND FINISHES – INSIDE BACK COVER



TPT - x x x

Toaster Pop-Up Type | Voltage



## Toast-Qwik® Conveyor Toasters

Hatco's next generation of Toast-Qwik® Toasters have been designed to provide a great look, easy to use touchscreen controller (excluding TQ3-10, -20 and -20H) and increased production capabilities. They continue to provide the best reliability, flexibility and value of any conveyor toaster available!

- Patented ColorGuard Sensing System which continually monitors and adjusts the chamber to ensure consistent toast results - even in your busiest periods
- The TQ3-10 features an Air Intake Filter screen on the front of the unit, while the rest of the line feature a removeable bottom screen. Both versions are removable for easy cleaning
- Power Save mode activates manually by pressing the Power Save Button (green leaf symbol), which reduces power by 50%
- Crumb tray is removable for easy cleaning
- Up to 12 programmable settings for precise and instant product changes (excludes TQ3-10, -20 and -20H)
- USB port for software updates (excludes TQ3-10, -20 and -20H)
- 2" high opening standard - 3" high opening available on the TQ3-20H, -500H, -900H and -2000H models for thicker bread products



**TQ3-2000**  
in optional  
Stainless Steel



**TQ3-500** in  
optional *Designer*  
Warm Red



**TQ3-20H**  
in standard  
*Designer* Black



**TQ3-10**  
available in  
*Designer* Black only

### HORIZONTAL CONVEYOR TOASTERS

Model	Opening Dimensions (W x H)	Dimensions (W x D x H) <i>Height includes legs</i>	Voltage 50/60Hz	Watts	Amps	Plug	Approx. Ship Weight	List Price
<b>TQ3-10*</b>	10 <sup>3</sup> / <sub>8</sub> " x 2"	14 <sup>1</sup> / <sub>2</sub> " x 21 <sup>3</sup> / <sub>16</sub> " x 16 <sup>3</sup> / <sub>16</sub> "	<b>120</b>	1780	14.8	NEMA 5-15P	54 lbs.	<b>\$1560</b>
<b>TQ3-10</b>	10 <sup>3</sup> / <sub>8</sub> " x 2"	14 <sup>1</sup> / <sub>2</sub> " x 21 <sup>3</sup> / <sub>16</sub> " x 16 <sup>3</sup> / <sub>16</sub> "	<b>208 or 240</b>	1780	8.6 or 7.4	NEMA 6-15P	54 lbs.	<b>1560</b>
<b>TQ3-20</b>	10 <sup>3</sup> / <sub>8</sub> " x 2"	14 <sup>3</sup> / <sub>8</sub> " x 20 <sup>1</sup> / <sub>16</sub> " x 17 <sup>5</sup> / <sub>16</sub> "	208	2470	11.9	NEMA 6-15P	54 lbs.	<b>4230</b>
<b>TQ3-20</b>	10 <sup>3</sup> / <sub>8</sub> " x 2"	14 <sup>3</sup> / <sub>8</sub> " x 20 <sup>1</sup> / <sub>16</sub> " x 17 <sup>5</sup> / <sub>16</sub> "	240	2470	10.3	NEMA 6-15P	54 lbs.	<b>4230</b>
<b>TQ3-20H</b>	10 <sup>3</sup> / <sub>8</sub> " x 2"	14 <sup>3</sup> / <sub>8</sub> " x 20 <sup>1</sup> / <sub>16</sub> " x 17 <sup>5</sup> / <sub>16</sub> "	208	2620	12.6	NEMA 6-20P	54 lbs.	<b>4268</b>
<b>TQ3-20H</b>	10 <sup>3</sup> / <sub>8</sub> " x 2"	14 <sup>3</sup> / <sub>8</sub> " x 20 <sup>1</sup> / <sub>16</sub> " x 17 <sup>5</sup> / <sub>16</sub> "	240	2620	10.9	NEMA 6-15P	54 lbs.	<b>4268</b>

### HORIZONTAL CONVEYOR TOASTERS

Model	Opening Dimensions (W x H)	Dimensions (W x D x H) <i>Height includes legs</i>	Voltage 50/60Hz	Watts	Amps	Plug	Approx. Ship Weight	List Price
<b>TQ3-400*</b> □	10 <sup>3</sup> / <sub>8</sub> " x 2"	14 <sup>3</sup> / <sub>8</sub> " x 20 <sup>5</sup> / <sub>16</sub> " x 17 <sup>1</sup> / <sub>8</sub> "	120	1780	14.8	NEMA 5-15P	48 lbs.	<b>\$2998</b>
<b>TQ3-500</b>	10 <sup>3</sup> / <sub>8</sub> " x 2"	14 <sup>3</sup> / <sub>8</sub> " x 20 <sup>5</sup> / <sub>16</sub> " x 17 <sup>1</sup> / <sub>8</sub> "	208 or 240	2220	10.7 or 9.3	NEMA 6-15P	54 lbs.	<b>3195</b>
<b>TQ3-500H</b>	10 <sup>3</sup> / <sub>8</sub> " x 3"	14 <sup>3</sup> / <sub>8</sub> " x 20 <sup>5</sup> / <sub>16</sub> " x 17 <sup>1</sup> / <sub>8</sub> "	208 or 240	2220	10.7 or 9.3	NEMA 6-15P	54 lbs.	<b>3195</b>
<b>TQ3-900</b>	10 <sup>3</sup> / <sub>8</sub> " x 2"	14 <sup>3</sup> / <sub>8</sub> " x 20 <sup>5</sup> / <sub>16</sub> " x 17 <sup>1</sup> / <sub>8</sub> "	208 or 240	3020	14.5 or 12.6	NEMA 6-20P	50 lbs.	<b>3413</b>
<b>TQ3-900H</b>	10 <sup>3</sup> / <sub>8</sub> " x 3"	14 <sup>3</sup> / <sub>8</sub> " x 20 <sup>5</sup> / <sub>16</sub> " x 17 <sup>1</sup> / <sub>8</sub> "	208 or 240	3020	14.5 or 12.6	NEMA 6-20P	55 lbs.	<b>3413</b>
<b>Toasts Three Slices Wide</b>								
<b>TQ3-2000</b>	14 <sup>1</sup> / <sub>8</sub> " x 2"	18 <sup>3</sup> / <sub>4</sub> " x 23 <sup>5</sup> / <sub>8</sub> " x 17 <sup>1</sup> / <sub>8</sub> "	208 or 240	4020	19.3 or 16.8	NEMA 6-30P	67 lbs.	<b>\$4300</b>
<b>TQ3-2000H</b>	14 <sup>1</sup> / <sub>8</sub> " x 3"	18 <sup>1</sup> / <sub>2</sub> " x 22 <sup>3</sup> / <sub>4</sub> " x 17 <sup>1</sup> / <sub>8</sub> "	208 or 240	4020	19.3 or 16.8	NEMA 6-30P	67 lbs.	<b>4300</b>

\* Canadian model uses NEMA 5-20P.

□ TQ3-400 ships with a loose aluminum toast tray.

**All Horizontal Conveyor Toaster Models Feature:**  
Cord Location: 6' cord – back of unit, lower right corner.

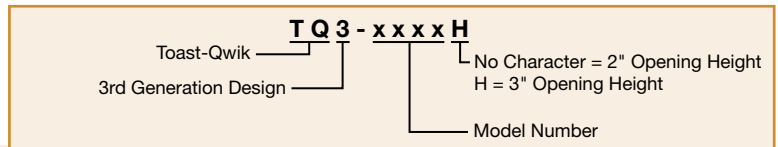

### OPTIONS (available at time of purchase only)

<b>Designer Colors – Non-standard colors are non-returnable – Designer Black Standard –</b>		
<b>SS</b>	Stainless Steel (excluding TQ3-10)	<b>\$266</b>
<b>WRED</b>	<i>Designer</i> Warm Red (excluding TQ3-10)	<b>No Charge</b>
<b>TQ3-30CORD</b>	NEMA 6-30P cord (in lieu of standard cord on TQ3-500 and -900 series only)	<b>\$100</b>
<b>SSINSERT</b>	Stainless Steel toast tray insert (on TQ3-500 and -900 series only)	<b>51</b>
<b>TQ3-RAMP</b>	Extended feed ramp in lieu of existing ramp - adds 3" (excludes TQ3-10 and -400 models)	<b>137</b>
<b>TQ3-RAMP-XL</b>	XL extended feed ramp in lieu of existing ramp - adds 9" (on TQ3-500 and -900 models only)	<b>51</b>

### COLORS AND FINISHES – INSIDE BACK COVER



## Toast-Qwik® Conveyor Toasters

Flexibility and performance are yours with the Hatco Toast-Qwik® conveyor toasters. These toasters produce perfect golden toasting, from 300 to 1800 slices per hour. The power save mode conserves energy during non-peak serving times.

- Instant and precise adjustment of toast color with electronic infinite controls that regulate top and bottom heat
- Patented ColorGuard sensing system assures toast uniformity (excludes TQ-10)
- Opening height for H and HBA models is 3", for all other models the opening height is 2"
- Insulation and an interior fan provide cool surface temperatures
- Efficient design of front or rear discharge allows unit to be placed where it is most convenient – for sending product to the operator side or to the customer/server side
- TQ-1800 Series are 3-slice wide
- BA models toast one side only and are for bagels and buns, cut side up



TQ-10



TQ-800HBA

### HORIZONTAL CONVEYOR TOASTERS

Model	Dimensions (W x D x H) Height includes legs	Opening Dimensions (W x H)	Voltage/60Hz	kW	Plug	Capacity/ Minute <sup>‡</sup>	Approx. Ship Weight	List Price
TQ-10*	14½" x 17¾" x 13¾"	10¾" x 2"	120	1.8	NEMA 5-15P	5 slices	42 lbs.	<b>\$1970</b>
TQ-10	14½" x 17¾" x 13¾"	10¾" x 2"	208, 240	1.8	NEMA 6-15P	5 slices	42 lbs.	<b>1970</b>

### HORIZONTAL CONVEYOR TOASTERS

Model	Dimensions W x D x H †	Opening Dimensions (W x H)	Voltage/60Hz	kW	Plug	Capacity/ Minute <sup>‡</sup>	Approx. Ship Weight	List Price
TQ-400*	14½" x 17¾" x 14⅞"	10¼" x 2"	120	1.8	NEMA 5-15P	6 slices	46 lbs.	<b>\$3075</b>
TQ-400	14½" x 17¾" x 14⅞"	10¼" x 2"	208, 240	2.2	NEMA 6-15P	6 slices	46 lbs.	<b>3075</b>
TQ-400BA*†	14½" x 17¾" x 14⅞"	10¼" x 2"	120	1.8	NEMA 5-15P	6 slices	46 lbs.	<b>3075</b>
TQ-400BA†	14½" x 17¾" x 14⅞"	10¼" x 2"	208, 240	1.9	NEMA 6-15P	6 slices	46 lbs.	<b>3075</b>
TQ-400H	14½" x 17¾" x 15⅞"	10¼" x 3"	208, 240	2.2	NEMA 6-15P	6 slices	46 lbs.	<b>3075</b>
TQ-800	14½" x 22¾" x 16⅞"	10¾" x 2"	208	3.3	NEMA 6-20P	14 slices	62 lbs.	<b>3506</b>
TQ-800**	14½" x 22¾" x 16⅞"	10¾" x 2"	240	3.3	NEMA 6-15P	14 slices	62 lbs.	<b>3506</b>
TQ-800BA†	14½" x 22¾" x 16⅞"	10¾" x 2"	208	3.3	NEMA 6-20P	14 slices	62 lbs.	<b>3506</b>
TQ-800BA†**	14½" x 22¾" x 16⅞"	10¾" x 2"	240	3.3	NEMA 6-15P	14 slices	62 lbs.	<b>3506</b>
TQ-800H	14½" x 22¾" x 16⅞"	10¾" x 3"	208	3.3	NEMA 6-20P	14 slices	62 lbs.	<b>3506</b>
TQ-800H**	14½" x 22¾" x 16⅞"	10¾" x 3"	240	3.3	NEMA 6-15P	14 slices	62 lbs.	<b>3506</b>
TQ-800HBA†	14½" x 22¾" x 16⅞"	10¾" x 3"	208	3.3	NEMA 6-20P	13 slices	62 lbs.	<b>3506</b>
TQ-800HBA†**	14½" x 22¾" x 16⅞"	10¾" x 3"	240	3.3	NEMA 6-15P	13 slices	62 lbs.	<b>3506</b>

#### Toasts Three Slices Wide

TQ-1800	18½" x 22¾" x 16⅞"	14¾" x 2"	208, 240	4.4	NEMA 6-30P	30 slices	73 lbs.	<b>\$4366</b>
TQ-1800BA†	18½" x 22¾" x 16⅞"	14¾" x 2"	208, 240	4.6	NEMA 6-30P	30 slices	73 lbs.	<b>4366</b>
TQ-1800H	18½" x 22¾" x 16⅞"	14¾" x 3"	208, 240	4.7	NEMA 6-30P	30 slices	73 lbs.	<b>4366</b>
TQ-1800HBA†	18½" x 22¾" x 16⅞"	14¾" x 3"	208, 240	4.6	NEMA 6-30P	30 slices	73 lbs.	<b>4366</b>

‡ Toasting capacity may vary by product. Toasting of coated products not recommended.

† Height includes legs. TQ-400 and TQ-400BA, add 2½" to depth if using tray extension in rear. TQ-800, TQ-800BA, TQ-800H, TQ-800HBA, TQ-1800, TQ-1800BA, TQ-1800H and TQ-1800HBA, add 6½" to depth if using tray extension in rear.

\* Canadian model uses NEMA 5-20P.

† BA models toast one side only and are for bagels and buns, cut side up.

\*\* Canadian model uses NEMA 6-20P.

#### All Conveyor Toaster Models Feature:

Cord Location: 6' cord – back of unit, lower right corner.

Toast-Qwik Toasters can be shipped Fed-Ex Ground or United Parcel Service.

#### OPTIONS AND ACCESSORIES – PAGE 207

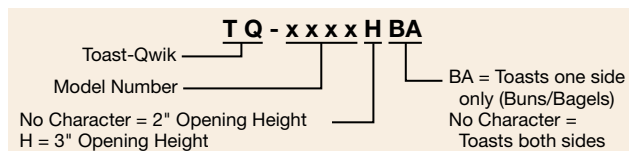



**TQ-800H** Toast Qwik®  
Horizontal Conveyor Toaster

**OPTIONS** (available at time of purchase only, excludes TQ-10)

**TQ-PWR-A** Automatic Power Save Mode (switches to Power Save Mode after 30 minutes of inactivity) **No Charge**

**ACCESSORIES** (available for purchase at any time)

**TQRAMP** Additional Extended Feed Guide adds 3" (not available on TQ-1800 Series) **\$139**  
**TQ2-SECURITY** Control Cover and Bracket (not available on TQ-1800 series) **128**



**TQ-800** with **TQ2-SECURITY** accessory security control cover

Toasters

**TQ TOASTER AMP RATINGS**

Model	120V/1 Ø	208V/1 Ø	240V/1 Ø
TQ-10	15.0	8.8	7.6
TQ-400	14.9	10.7	9.3
TQ-400BA	14.8	9.0	7.8
TQ-400H		10.3	9.3
TQ-800		16.0	13.9
TQ-800BA		15.8	13.7
TQ-800H		16.0	13.9
TQ-800HBA		15.8	13.7
TQ-1800		21.4	18.5
TQ-1800H		22.4	19.4
TQ-1800BA		22.0	19.1
TQ-1800HBA		22.0	19.1



## Toast King® Conveyor Toasters

Designed for mid-to high-volume and constant flow applications, Hatco's proven reliability and performance makes the Toast King® Toasters the workhorse of your operation. These toasters use conveyor speed, not temperature, to determine toast color.

- Toasts a variety of bread products
- Stainless steel construction for years of trouble-free service
- Power-saving thermostat for energy savings during non-peak times
- Manual advance, speed control and cord with plug included
- Fully insulated for cooler operation
- Multiple metal sheathed toasting elements
- Toast storage area keeps bread warm and dry
- Capacity of 720-1500 slices per hour
- Three basket access for fast loading
- Top venting keeps heat away from the operator



TK-135B



TK-72

### VERTICAL CONVEYOR TOASTERS

Model	Description	Dimensions <sup>↔</sup> W x D x H	Basket Size W x H	Voltage		Capacity/ Minute <sup>⊥</sup>	Plug	Approx. Ship Weight	List Price
				Single Phase	H <sub>z</sub>				
TK-72*	Bread and Buns	18 1/4" x 17 1/2" x 33 1/4"	10" x 4 5/8"	208 or 240	60	12 slices	NEMA 6-20P	73 lbs.	\$5465
TK-100	Bread and Buns	22 3/4" x 17 1/2" x 33 1/4"	14 1/2" x 4 5/8"	208 or 240	60	16 slices	NEMA 6-30P	88 lbs.	5847
TK-135B <sup>↗</sup>	Buns Only	22 3/4" x 17 1/2" x 33 1/4"	14 1/2" x 4 5/8"	208 or 240	60	22 slices	NEMA 6-30P	88 lbs.	5849
TK-155B	3-Part Buns	22 3/4" x 17 1/2" x 33 1/4"	14 1/2" x 4 5/8"	208 or 240	60	25 slices	NEMA 6-30P	88 lbs.	6166

↔ Width included 3/4" for manual advance knob. Depth includes tray extension of 3 1/2".

⊥ Toasting capacity may vary by product. Toasting of coated products not recommended.

\* Canadian model uses NEMA 6-30P.

↗ 240V model uses NEMA 6-20P (Canadian model uses NEMA 6-30).

#### All Vertical Conveyor Toaster Models Feature:

Max. Product Thickness: 1 1/4".

Cord Location: 4' cord – back of unit, lower left side.

Toasters

#### OPTIONS (available at time of purchase only)

TK-SECURITY	Control Cover, Bracket, Mounting Hardware and Fuse Cover	\$253
-------------	--	-------

#### ACCESSORIES (available for purchase at any time)

4" LEGS	4" Adjustable Legs (4)	\$66
---------	------------------------	------

#### TK TOASTER AMP RATINGS

Model	208V/1 Ø		240V/1 Ø
	Amps	Amps	kW
TK-72	19.4	16.8	4.0
TK-100	24.0	21.0	5.0
TK-135B	20.9	18.1	4.3
TK-155B	24.1	20.9	5.0

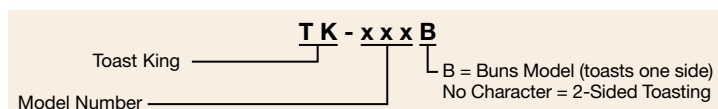



# Induction Equipment

*Cafeterias • Buffets*  
*Supermarkets & Delis • Restaurants & Cafés*  
*Clubs & Bars*



**IWELB-FUL -A** with accessory food pans *pg. 210*



**IRNG-BXC1-14** *pg. 211*



**IRNG-HC1-14** *pg. 212*



**IRNG-PC1-18** *pg. 213*



**IRNG-PB1-18** *pg. 214*



**IRNG-PC1-36** *pg. 215*



**IWRM-CD1-03** *pg. 219*



**IWRM-B1-1313-06** with white glass-ceramic top *pg. 220*



**IWRM-UT-06** *pg. 221*



## Drop-In Induction Dry Well

Hatco's Drop-In Induction Dry Well features a simple, robust design and offers an energy efficient, plumbing-free solution to any food holding needs. This unit is adjustable with little effort and can hold either a 2½" or 4" deep pan. The well evenly and consistently heats the pan to keep foods hot and fresh.

- Durable and tough glass-ceramic well bottom can be easily adjusted to accommodate a 2½" or 4" deep pan
- Made for use with normal, full-size, ½-size, ¼-size & ¼-size, stainless steel pans
- Contains two heat zones with two temperature sensors in each zone
- An easy-to-use, mountable control panel that can be adjusted by temperatures in Fahrenheit, Celsius or by preset temperature levels between 150° and 210°F
- Features a sensor that prohibits the unit to turn on unless a pan is present
- Includes a single stainless steel bezel
- Can be top or bottom mounted into a countertop



**IWELB-FUL-A**  
with standard full-size pan



**IWELB-FUL-A**  
adjusted for a 2½" deep pan



**IWELB-FUL-A**  
adjusted for a 4" deep pan

### DROP-IN INDUCTION DRY WELL

Model	Dimensions W x D x H	Voltage Single Phase	Watts	Plug	Approx. Ship Weight	List Price
<b>IWELB-FUL-A</b>	24" x 16" x 9⅓"	120	720	NEMA 5-15P	43 lbs.	<b>\$2950</b>
<b>IWELB-FUL-A</b>	24" x 16" x 9⅓"	208-240	720	NEMA 6-15P	43 lbs	<b>\$2950</b>

#### All Drop-In Induction Dry Well Models Feature:

Models Shipped with: A 78" cable from the base to the control and a 71" cord and plug.  
Cord Location: Bottom right side.

### ACCESSORIES (available for purchase at any time)

#### Pans –

<b>ST PAN 1/3</b>	Third-Size Stainless Steel Pan	<b>\$ 68</b>
<b>ST PAN 1/2</b>	Half-Size Stainless Steel Pan	<b>78</b>
<b>ST PAN 2</b>	Full-Size Stainless Steel Pan, 2½" depth	<b>93</b>
<b>ST PAN 4</b>	Full-Size Stainless Steel Pan, 4" depth	<b>117</b>

#### Bezels –

<b>IWELBEZEL-2</b>	For use when ganging two units	<b>\$242</b>
<b>IWELBEZEL-3</b>	For use when ganging three units	<b>330</b>

#### Trivets –

<b>TRIVET (1/2) SS</b>	Half-Size – 10⅜"W x 7⅝"D	<b>\$126</b>
<b>TRIVET SS</b>	Full-Size – 10⅞"W x 18"D	<b>175</b>



**IWELBEZEL-3**

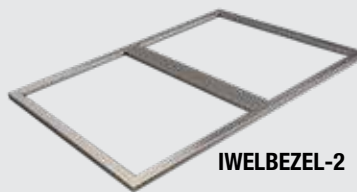

**IWELBEZEL-2**

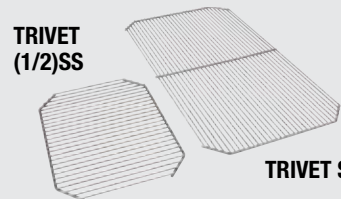

**TRIVET (1/2)SS**

**TRIVET SS**

### IWELB - FUL - A

Induction Dry Well \_\_\_\_\_  
Drop-In \_\_\_\_\_  
A = Adjustable to 2½" or 4" Depth  
FUL = Full-Size Pan



## Boxer® Countertop Induction Ranges

Hatco's Boxer® Induction Range has all the same power as our Hatco line of induction ranges, but with no frills. This economy model is simple to operate and has the Magnetic Power System (MPS), delivering the highest power in its class!

This unit has all the basics for the rigors of commercial foodservice use, as well as a timer with convenient power and temperature modes.

- Heavy gauge stainless steel housing with side impact protection for the top
- Large control knob is adaptive and adjusts to user input. From precise, fine control (slow turns) to spanning the full range in a single twist (fast turns)
- Display instantly advises the operator of precise power, temperature (°F or °C) and time control (30 seconds to 1 hour)
- Black, glass-ceramic top is durable and easy to clean – fully sealed top and conformal-coated boards add extra protection against grease or moisture
- Suitable for front of the house use with an ultra-quiet cooling fan
- Safety and convenience features, such as automatic shut-off, to prevent overheating

IRNG-BXC1-14



Close up of patterned black glass-ceramic top – helps prevent noticeable scratches due to heavy use



### BOXER COUNTERTOP INDUCTION RANGES

Model	Item No.	Dimensions W x D x H	Voltage Single Phase	Watts	Approx. Ship Weight	List Price
<b>IRNG-BXC1-14</b>	IRNGBXC114515	12 <sup>7</sup> / <sub>8</sub> " x 17 <sup>5</sup> / <sub>8</sub> " x 4"	120	1440	17 lbs.	<b>\$1294</b>
<b>IRNG-BXC1-18*</b>	IRNGBXC118515	12 <sup>7</sup> / <sub>8</sub> " x 17 <sup>5</sup> / <sub>8</sub> " x 4"	120	1800	18 lbs.	<b>1294</b>

\* Not available for Canada.

**All Boxer Countertop Induction Range Models Feature:**

**Models Shipped with:** A 71" cord and plug.

**Cord Location:** Rear right bottom base corner.

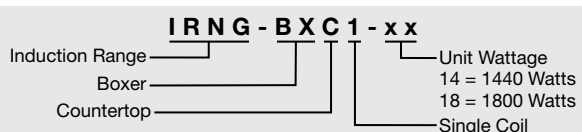



### Rapide Cuisine® Countertop Heavy-Duty Induction Ranges

Hatco's Rapide Cuisine® Heavy-Duty Induction Range is designed for intense commercial foodservice applications. This model is simple to operate and has the Magnetic Power System (MPS), delivering the highest power in its class!

The unit features a large control knob, extra side impact protection and a scratch-hiding cooktop surface.

- Large control knob is adaptive and adjusts to user input. From precise, fine control (slow turns) to spanning the full range in a single twist (fast turns)
- Patterned, glass-ceramic top that is durable, easy to clean and helps scratches from heavy use appear less noticeable
- Includes a grease filter and extra side impact protection
- High resolution TFT (thin film transistor) display instantly advises the operator of precise power (1 to 100) and time control (30 seconds to 10 hrs.)
- Fully-sealed top with conformal coated boards adds extra protection against grease or moisture
- Keeps its "cool" even in hot kitchen environments
- Pan Sense Technology (PST) activates the unit only when a suitable pan is placed on top
- Safety and convenience features such as automatic shut-off to prevent overheating
- Low-profile, contemporary design and low noise cooling fan
- USB port for downloading updates

Close up of patterned black glass-ceramic top – helps prevent noticeable scratches due to heavy use



IRNG-HC1-14

#### COUNTERTOP HEAVY-DUTY INDUCTION RANGES

Model	Item No.	Dimensions W x D x H	Voltage Single Phase	Watts	Approx. Ship Weight	List Price
IRNG-HC1-14	IRNGHC114SB515	13" x 17" x 3 3/8"	120	1440	17 lbs.	<b>\$1630</b>
IRNG-HC1-18*	IRNGHC118SB515	13" x 17" x 3 3/8"	120	1800	17 lbs.	<b>1630</b>

\* Not available for Canada.

#### All Countertop Heavy-Duty Induction Range Models Feature:

Models Shipped with: A 71" cord and plug.

Cord Location: Rear left bottom base corner.

Induction Equipment

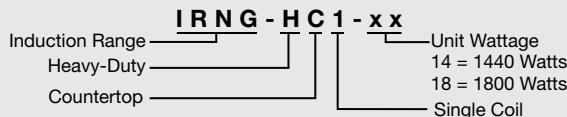



## Rapide Cuisine® Countertop Induction Ranges

Hatco's Rapide Cuisine® Professional Induction Range is designed and built for the rigors of commercial foodservice use. Its Magnetic Power System (MPS) delivers the highest power in its class!

It has brains and beauty with a sleek, modern, low-profile design, high resolution color display, timer, plus convenient power and temperature modes. All this and energy efficient too!

- Programmable mode where the operator can create preset programs for consistent cooking cycles
- High resolution TFT (thin film transistor) displays instantly advises the operator of precise power (1 to 100), temperature (°F or °C in one degree increments) and time control (30 seconds to 10 hours)



- Tough enough for back-of-the-house cooking and prep areas but is still easily portable and adaptable for buffets and many other front-of-the-house applications

- Easy to use color-coded selectable functions
- Adaptive control knob adjusts to user input. From precise, fine control (slow turns) to spanning the full range in a single twist (fast turns)
- Elegant, contemporary, low-profile, design with a choice of color combinations to match your décor



- Pan Sense Technology (PST) activates the unit only when a suitable pan is placed on top
- Black glass-ceramic top is durable and easy to clean – fully-sealed top and conformal coated boards adds extra protection against grease or moisture
- Automatic shut-off to prevent overheating
- Withstands high ambient kitchen temperatures up to 124°F
- USB port for downloading updates



Includes a food temperature probe which facilitates highly accurate cooking

**IRNG-PC1-14**  
shown in the standard finishes

### COUNTERTOP INDUCTION RANGES

Model	Item No.	Dimensions W x D x H	Top Housing	Bottom Housing	Voltage Single Phase	Watts	Approx. Ship Weight	List Price
<b>IRNG-PC1-14</b>	IRNGPC114SB515	13" x 17" x 3 3/8"	Stainless Steel (Standard)	Bold Black (Standard)	120	1440	17 lbs.	<b>\$1497</b>
<b>IRNG-PC1-18*</b>	IRNGPC118SB515	13" x 17" x 3 3/8"	Stainless Steel (Standard)	Bold Black (Standard)	120	1800	17 lbs.	<b>1497</b>
<b>IRNG-PC1-18*</b>	IRNGPC118BB515	13" x 17" x 3 3/8"	Bold Black	Bold Black	120	1800	17 lbs.	<b>1497</b>

\* Not available for Canada.

#### All Countertop Induction Range Models Feature:

Models Shipped with: A 71" cord and plug and a food temperature probe.  
Cord Location: Rear left bottom base corner.

#### COLORS AND FINISHES – INSIDE BACK COVER



**IRNG-PC1-18**  
shown in the Bold Black top and bottom housing

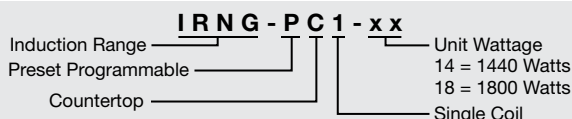



## Rapide Cuisine® Drop-In Induction Ranges

Hatco's Rapide Cuisine® Drop-In Professional Induction Range is designed and built for the rigors of commercial foodservice use. Its Magnetic Power System (MPS) delivers the highest power in its class!

This unit can be mounted flush or near flush with the optional trim ring. It has brains and beauty with a high resolution color display, timer, plus convenient power and temperature modes.

- Programmable mode where the operator can create preset programs for consistent cooking cycles and quality product
- High resolution TFT (thin film transistor) display instantly advises the operator of precise power (1 to 100), temperature (°F or °C in one degree increments) and time control (30 seconds to 10 hours)



- Easy to use, color-coded selectable functions

- Adaptive control knob adjusts to user input. From precise, fine control (slow turns) to spanning the full range in a single twist (fast turns)
- Pan Sense Technology (PST) activates the unit only when a suitable pan is placed on top
- Black glass-ceramic top is both durable and easy to clean
- Fully-sealed top with conformal coated boards add extra protection against grease or moisture
- Safety and convenience features such as automatic shut-off to safely prevent overheating
- USB port for downloading updates



IRNG-PB1-18



Includes a food temperature probe which facilitates highly accurate cooking

### DROP-IN INDUCTION RANGES

Model	Item No.	Dimensions W x D x H	Voltage Single Phase	Watts	Approx. Ship Weight	List Price
IRNG-PB1-14	IRNGPB114515	13½" x 14½" x 3½"	120	1440	17 lbs.	\$1630
IRNG-PB1-18*	IRNGPB118515	13½" x 14½" x 3½"	120	1800	17 lbs.	1630

\* Canadian model (Item No. IRNGPB118520).

#### All Drop-In Induction Range Models Feature:

Control Panel: 12"W x 4½"H.

Models Shipped with: A 51" cable from the base unit to the control panel, a 71" cord and plug, and a food temperature probe.

Cord Location: Rear left bottom base corner.

### ACCESSORY (available at any time)

**Holds unit nearly flush on the counter (for use where chair-step routing of a countertop material is not possible (stainless steel or any similar material), but a flush mount look is desired) –**

Trim Ring in Stainless Steel for IRNG-PB1-14 or -18 (holds unit nearly flush

on a stainless steel or any similar material countertop) **\$66**

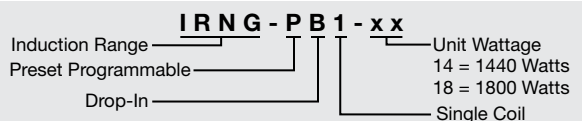

## Rapide Cuisine® Countertop High-Powered/Heavy-Duty Induction Ranges

Hatco's Rapide Cuisine® High-Powered/Heavy-Duty Induction Ranges offer industry leading features and true back-of-house power in a commercial kitchen-proof package.

The unit features our Magnetic Power System (MPS) to deliver the highest power in its class! It has User Programmable Presets (UPP) for repeat menu items and a food temperature probe for more accurate cooking, plus a timer, high resolution color display and convenient power and temperature modes.

- Commercial kitchen ready. Heavy gauge stainless steel housing with side impact protection for the top
- Four surface temperature sensors offer the most accurate control in its class
- Culinary equivalent of up to 31,000 BTUs gas
- High resolution TFT (thin film transistor) display instantly advises the operator of precise power (1 to 100), temperature (°F in one degree increments) and time control (30 seconds to 10 hours)
- Programmable mode so the operator can create preset programs for consistent cooking cycles
- Includes a grease filter and conformal-coated boards
- Easy to use color-coded selectable functions
- Large adaptive control for precise, fine control (slow turns) to spanning the full range in a single twist (fast turns)
- Pan Sense Technology (PST) activates the unit only when a suitable pan is placed on top
- Patterned, glass-ceramic top that is durable, easy to clean and helps scratches from heavy use become less noticeable
- Easy to clean, fully-sealed top, stops grease or moisture from penetrating the unit, even if the top gets broken
- Automatic shut-off to prevent overheating
- Withstands high ambient kitchen temperatures (up to 124°F)
- USB port for downloading updates



IRNG-PC1-36

Close up of patterned black glass-ceramic top – helps prevent noticeable scratches due to heavy use

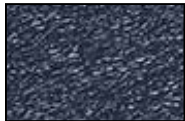

Includes a food temperature probe which facilitates highly accurate cooking

### COUNTERTOP HIGH-POWERED/HEAVY-DUTY INDUCTION RANGES

Model	Item No.	Dimensions W x D x H	Voltage Single Phase	Watts	Approx. Ship Weight	List Price
IRNG-PC1-36	IRNGPC136SB620	13 <sup>7</sup> / <sub>8</sub> " x 18 <sup>5</sup> / <sub>8</sub> " x 3 <sup>3</sup> / <sub>4</sub> "	208-240	3120-3600	22 lbs.	\$2379

**All Countertop High-Powered/Heavy-Duty Induction Range Models Feature:**  
**Models Shipped with:** A 71" cord and plug and a food temperature probe.  
**Cord Location:** Rear left bottom base corner.

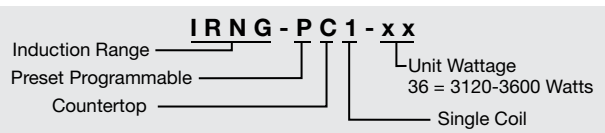



## Rapide Cuisine® Drop-In High-Powered/Heavy-Duty Induction Ranges

Hatco's Rapide Cuisine® Drop-In High-Powered/Heavy-Duty Induction Ranges offer industry-leading features and true back-of-house power in a commercial kitchen-proof package.

The unit can be mounted flush or near flush with the optional trim ring. It features our Magnetic Power System (MPS) to deliver the highest power in its class! It has User Programmable Presets (UPP) for repeat menu items and a food temperature probe for more accurate cooking, plus a timer, high resolution color display and convenient power and temperature modes.

- Four surface temperature sensors offer the most accurate control in its class
- Culinary equivalent of up to 31,000 BTUs gas
- High resolution TFT (thin film transistor) display instantly advises the operator of precise power (1 to 100), temperature (°F or °C in one degree increments) and time control (30 seconds to 10 hours)
- Programmable mode so the operator can create preset programs for consistent cooking cycles
- Includes conformal-coated boards
- Easy to use color-coded selectable functions
- Large adaptive control for precise, fine control (slow turns) to spanning the full range in a single twist (fast turns)
- Pan Sense Technology (PST) activates the unit only when a suitable pan is placed on top
- Patterned, glass-ceramic top that is durable, easy to clean and helps scratches from heavy use become less noticeable
- Easy to clean, fully-sealed top stops grease or moisture from penetrating the unit, even if the top gets broken
- Automatic shut-off to safely prevent overheating
- Withstands high ambient kitchen temperatures (up to 124°F)
- USB port for downloading updates



Includes a food temperature probe which facilitates highly accurate cooking

Close up of patterned black glass-ceramic top – helps prevent noticeable scratches due to heavy use

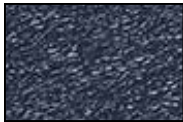

### DROP-IN HIGH-POWERED/HEAVY-DUTY INDUCTION RANGES

Model	Item No.	Dimensions W x D x H	Voltage Single Phase	Watts	Approx. Ship Weight	List Price
IRNG-PB1-36	IRNGPB136SB620	13½" x 14½" x 3 5/8"	208-240	3120-3600	20 lbs.	\$2510

All Drop-In High-Powered/Heavy-Duty Induction Range Models Feature:  
Models Shipped with: A 51" cable from the base unit to the control panel, a 71" cord and plug, and a food temperature probe.  
Cord Location: Rear right bottom base corner.

#### ACCESSORY (available for purchase at any time)

Holds unit nearly flush on the counter (for use where chair-step routing of a countertop material is not possible, but a flush mount look is desired) –

TRIM-PB1-36	Trim Ring in Stainless Steel (holds unit nearly flush on a stainless steel or any similar material countertop)	\$66
-------------	--	------

Induction Equipment

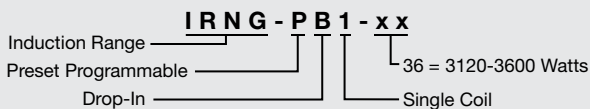



## Rapide Cuisine® Countertop High-Powered/Heavy-Duty Dual Induction Ranges

Hatco's Rapide Cuisine® High-Powered/Heavy-Duty Dual Induction Ranges offer industry-leading features and true back-of-house power in a commercial kitchen proof package. These are dual units that are configured either front-to-back or side-to-side to optimize your countertop footprint.

The unit features optimization systems like Magnetic Power System (MPS) to deliver the highest power in its class; safety features like Pan Sense Technology (PST), which means the unit only activates when a pan is present; and convenience features like User Programmable Presets (UPP), where up to six menu items using three stages of cooking can be programmed and saved -- great for repeat menu items. You can also choose a power level and doneness temperature target when using the temperature food probe(s).

More powerful options to suit available power units. The industry leading "IA" models feature Optimal Power Control (OPC) which delivers higher power from lower amperage circuits, boosting power by 25% when needed, and allowing for a double unit on what would normally be a single unit circuit. Allows a double unit to occupy the same linear footprint as a single unit, hence doubling production while remaining within UL standard.

- Food temperature probes for more accurate cooking
- Timers (up to 10 hours, more if in program mode)

- High resolution color displays
- Power (0-100) or temperature (°F or °C modes)
- Heavy gauge stainless steel housing with side impact protection for the top
- Eight surface temperature sensors
- Culinary equivalent of up to 31,000 BTUs gas per burner
- Grease filters
- Highest ambient tolerance on the market 124°F - it's tough
- Numerous options to suit available power circuits, including the unique "IA" models that deliver the highest available power from lower amperage circuits
- USB ports for downloading updates

**IRNG-PC2F-36**  
Front-to-back  
configuration shown



**IRNG-PC2S-36**  
Side-to-side configuration shown

### COUNTERTOP HIGH-POWERED/HEAVY-DUTY DUAL INDUCTION RANGES

Model	Item No.	Configuration	Dimensions W x D x H	Voltage Single Phase	Watts (per coil)	Total Power (watts)	Approx. Ship Weight	List Price
<b>Front to Back Ranges</b>								
<b>IRNG-PC2F-29</b>	IRNGPC2F29630	Front to Back	14" x 29 11/16" x 5 1/4"	208-240	2496-2880	4992-5760	41 lbs.	<b>\$4656</b>
<b>IRNG-PC2F-36</b>	IRNGPC2F36650	Front to Back	14" x 29 11/16" x 5 1/4"	208-240	3120-3600	6240-7200	41 lbs.	<b>5171</b>
<b>Front to Back – Input Averaging Ranges</b>								
<b>IRNG-PC2F-24-IA</b>	IRNGPC2F24IA620	Front to Back	14" x 29 11/16" x 5 1/4"	208-240	1803-2400	3606-4800	41 lbs.	<b>\$4890</b>
<b>IRNG-PC2F-36-IA</b>	IRNGPC2F36IA630	Front to Back	14" x 29 11/16" x 5 1/4"	208-240	3120-3600	6240-7200	41 lbs.	<b>5430</b>
<b>Side to Side Ranges</b>								
<b>IRNG-PC2S-29</b>	IRNGPC2S29630	Side to Side	24 7/8" x 19" x 4 1/2"	208-240	2496-2880	4992-5760	40 lbs.	<b>\$4656</b>
<b>IRNG-PC2S-36</b>	IRNGPC2S36650	Side to Side	24 7/8" x 19" x 4 1/2"	208-240	3120-3600	6240-7200	40 lbs.	<b>5171</b>
<b>Side to Side Ranges – Input Averaging Range</b>								
<b>IRNG-PC2S-24-IA</b>	IRNGPC2S24IA620	Side to Side	24 7/8" x 19" x 4 1/2"	208-240	1803-2400	3606-4800	40 lbs.	<b>\$4890</b>
<b>IRNG-PC2S-36-IA</b>	IRNGPC2S36IA630	Side to Side	24 7/8" x 19" x 4 1/2"	208-240	3120-3600	6240-7200	40 lbs.	<b>5430</b>

**All Countertop High-Powered/Heavy-Duty Dual Induction Range Models Feature:**  
Models Shipped with: A 71" cord and plug and two food temperature probes.  
Cord Location: Rear left bottom base corner.



Includes dual food temperature probes which facilitate fast and highly accurate cooking

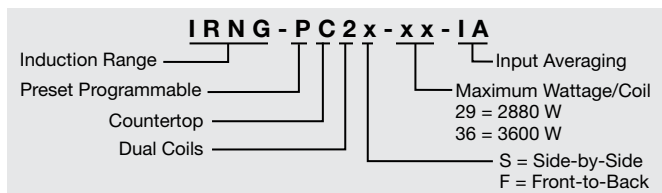



# Rapide Cuisine® Drop-In High-Powered/Heavy-Duty Dual Induction Ranges

Hatco's Rapide Cuisine® High-Powered/Heavy-Duty Drop-In Dual Induction Ranges offer industry-leading features and true back-of-house power in a commercial kitchen proof package. These are dual units that are configured either front-to-back or side-to-side to optimize your countertop footprint.

The unit features optimization systems like Magnetic Power System (MPS) to deliver the highest power in its class; safety features like Pan Sense Technology (PST), which means the unit only activates when a pan is present; and convenience features like User Programmable

Presets (UPP), where up to six menu items using three stages of cooking can be programmed and saved - great for repeat menu items. You can also choose a power level and doneness temperature target when using the temperature food probe(s).

More powerful options to suit available power units. The industry leading "IA" models feature Optimal Power Control (OPC) which delivers higher power from lower amperage circuits, boosting power by 25% when needed, and allowing for a double unit on what would normally be a single unit circuit. Allows a double unit to occupy the same linear footprint as a single unit, hence doubling production while remaining within UL standard.

- Food temperature probes for more accurate cooking
- Timers (up to 10 hours, more if in program mode)
- High resolution color displays
- Power (0-100) or temperature (°F or °C modes)
- Heavy gauge stainless steel housing with side impact protection for the top
- Eight surface temperature sensors
- Culinary equivalent of up to 31,000 BTUs gas per burner
- Grease filters
- Highest ambient tolerance on the market 124 °F (51°C)- it's tough
- Numerous options to suit available power circuits, including the unique "IA" models that deliver the highest available power from lower amperage circuits
- USB ports for downloading updates



Includes food temperature probes which facilitate fast and highly accurate cooking

## DROP-IN HIGH-POWERED/HEAVY-DUTY DUAL INDUCTION RANGES

Model	Item No.	Dimensions W x D x H	Voltage Single Phase	Watts (per coil)	Total Power (watts)	Approx. Ship Weight	List Price
<b>IRNG-PB2-29</b>	IRNGPB229630	13 <sup>13</sup> / <sub>16</sub> " x 27 <sup>9</sup> / <sub>16</sub> " x 6 <sup>1</sup> / <sub>4</sub> "	208/240	2496/2880	4992/5760	42 lbs.	<b>\$4367</b>
<b>IRNG-PB2-36</b>	IRNGPB236650	13 <sup>13</sup> / <sub>16</sub> " x 27 <sup>9</sup> / <sub>16</sub> " x 6 <sup>1</sup> / <sub>4</sub> "	208/240	3120/3600	6240/7200	42 lbs.	<b>4580</b>
<b>IA Models</b>							
<b>IRNG-PB2-24-IA</b>	IRNGPB224IA620	13 <sup>13</sup> / <sub>16</sub> " x 27 <sup>9</sup> / <sub>16</sub> " x 6 <sup>1</sup> / <sub>4</sub> "	208/240	1803/2400	3606/4800	42 lbs.	<b>\$4586</b>
<b>IRNG-PB2-36-IA</b>	IRNGPB236IA630	13 <sup>13</sup> / <sub>16</sub> " x 27 <sup>9</sup> / <sub>16</sub> " x 6 <sup>1</sup> / <sub>4</sub> "	208/240	3120/3600	6240/7200	42 lbs.	<b>4811</b>

**All Drop-In High-Powered/Heavy-Duty Dual Induction Range Models Feature:**  
Models Shipped with: Two 27½" cables from the base to the control, a 71" cord and plug, and two food temperature probes.  
Cord Location: Rear left bottom base corner.

### ACCESSORIES (available for purchase at any time)

**TRIM-PB2-SS** Trim Ring in Stainless Steel (holds unit nearly flush on a stainless steel or any similar material countertop) **\$130**

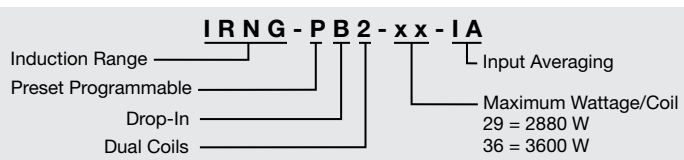

## Palletti® Countertop Induction Warmers

Hatco's Palletti® Countertop Professional Induction Warmers offer a safe, efficient and attractive way to keep hot foods hot. Perfect for serving applications such as buffet lines and hospitality suites. The warmer has five simple and precise settings, which allow for a wide variety of foods to be held both safely and at optimum quality. The units are also memory retentive, so once turned off and back on, the last setting will resume.

This unit has a low-profile and ultra-thin design in all black so the focus remains on the food rather than the equipment.

Choose either the stand-alone countertop which offers the greater 600 watts of power for large volumes or the lower watt daisy chain countertop unit where multiple units can be interconnected.

- Adaptable for buffets and many other front-of-the-house applications to give the most attractive and visible food presentations
- Energy efficient, quiet and safe operation with no open flames as with traditional warming presentations

- Elegant, contemporary, low-profile design with a bold black housing and black glass-ceramic top
- Pan Sense Technology (PST) activates the unit only when a suitable pan is placed on top
- Black glass-ceramic top is durable and easy to clean
- Automatic shut-off to safely prevent overheating



IWRM-C1-1317-06

### COUNTERTOP INDUCTION WARMERS

Model	Item No.	Dimensions W x D x H	Voltage Single Phase	Watts	Approx. Ship Weight	List Price
IWRM-C1-1317-06	IWRMC113176B515	13" x 17¾" x 2¼"	120	600	12 lbs.	\$1164

**All Countertop Induction Warmer Models Feature:**  
 Models Shipped with: A 71" cord and plug.  
 Cord Location: Rear right bottom base corner.



IWRM-CD1-03  
 (Shown with three Daisy Chain Countertop Induction Warmers interconnected to one power cord)

### DAISY CHAIN COUNTERTOP INDUCTION WARMERS

Model	Item No.	Dimensions W x D x H	Voltage Single Phase	Watts	Approx. Ship Weight	List Price
IWRM-CD1-03	IWRMCD13B515	13" x 17¾" x 2¼"	120	360	12 lbs.	\$1293

**All Daisy Chain Countertop Induction Warmer Models Feature:**  
 Maximum number of interconnected units: 5 units for US and 4 units for Canada  
 Models Shipped with: A 71" cord and plug and a 17" interconnecting cord.  
 Cord Location: Rear right bottom base corner.  
 Interconnecting Cord Location: Rear left and right bottom base corner.

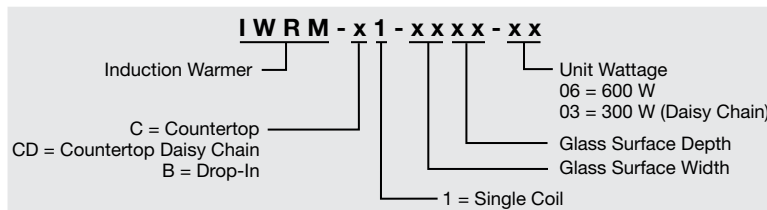



## Palletti® Drop-In Induction Warmers

Hatco's Palletti® Drop-In Professional Induction Warmers offer a safe, efficient and attractive way to keep hot foods hot. Perfect for serving applications such as buffet lines and hospitality suites. The warmer has five simple and precise settings, which allow for a wide variety of foods to be held both safely and at optimum quality. The units are also memory retentive, so once turned off and back on, the last setting will resume.

This unit can be mounted flush or near flush with the optional trim ring.

- Adaptable for buffets and many other front-of-the-house applications to give the most attractive and visible food presentations
- Pan sense technology (PST) activates the unit only when a suitable pan is placed on top
- Once installed the glass-ceramic top never needs to be removed. For service or replacement, the lower housing can be removed separately.
- Features a control panel with a standby key, temperature control arrow keys and temperature setting indicators
- Energy efficient, quiet and safe operation
- Choose black or white glass-ceramic top, both are durable and easy to clean
- Features for both safety and convenience, such as the automatic shut-off to prevent overheating
- Includes remote control panel and cord

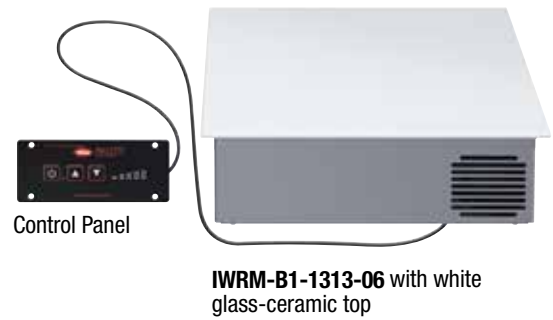
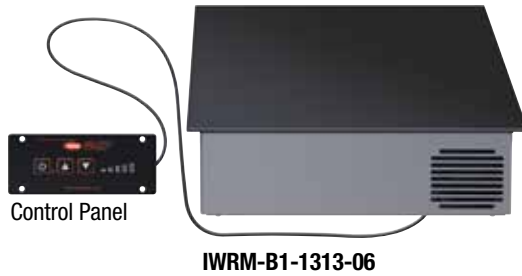

### DROP-IN INDUCTION WARMERS

Model	Item No.	Dimensions W x D x H	Glass-Ceramic Top.	Voltage Single Phase	Watts	Approx. Ship Weight	List Price
IWRM-B1-1313-06	IWRMB113136B515	13" x 13" x 4¼"	Black	120	600	13 lbs.	\$1164
IWRM-B1-1313-06	IWRMB113136W515	13" x 13" x 4¼"	White	120	600	13 lbs.	1164

#### All Drop-In Induction Warmer Models Feature:

Models Shipped with: A 39" cable from the base to the control and a 71" cord and plug.  
Cord Location: Rear left bottom base corner.

### ACCESSORIES (available for purchase at any time)

TRIM-IWRM-1B	Trim Ring in Stainless Steel (holds unit nearly flush on a stainless steel or any similar material countertop)	\$60
IWRM-FLUSHBKT	Flush Mount Bracket (Undermount leveling brackets, used with solid material or stainless steel countertop)	78

**NOTE:** Three installation options for a flush or near-flush look: see manual for details.

Induction Equipment

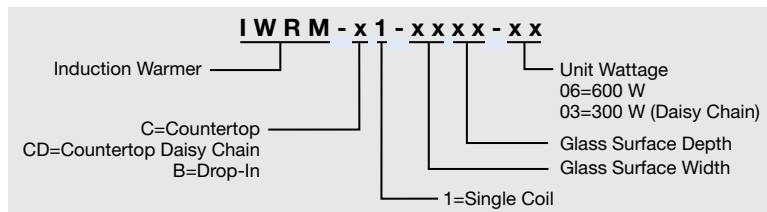



## Maskerade® Undercounter Induction Warmers

Hatco's patent-pending Maskerade® Undercounter Induction Warmers offer a simple and affordable solution for "invisible" hot food holding under a variety of countertop materials including engineered and natural stone. Perfect for serving applications such as buffet lines and hospitality suites as it eliminates the institutional look of traditional foodwarming equipment yet yields unlimited flexibility.

The warmer has five simple and precise settings, which allow for a wide variety of foods to be held both safely and at optimum quality. The units are also memory retentive, so once turned off and back on, the last setting will resume.

- Can be mounted under a wide variety of countertop materials including engineered and natural stone giving an "invisible" countertop appearance
- Includes one black flexible, highly slip-resistant trivet which locates the chafing dish and protects the stone from the heat of the pan
- Features a control panel with a standby key, temperature control arrow keys a lock key and temperature setting indicators
- Pan Sense Technology (PST) activates the unit only when a suitable pan is placed on the trivet
- Energy efficient, quiet and safe operation
- Features for both safety and convenience, such as the automatic shut-off to prevent overheating
- For easy service, the lower housing can be removed separately

IWRM-UT-06



### UNDERCOUNTER INDUCTION WARMERS

Model	Item No.	Dimensions W x D x H	Voltage Single Phase	Watts (per coil)	Approx. Ship Weight	List Price
IWRM-UT-06	IWRMBUT6515	15¼" x 15" x 3⅝"	120	600	17 lbs.	\$1877

**All Undercounter Induction Warmer Models Feature:**

Models Shipped with: A 71" cord and plug, a 79" control cable, and a trivet.  
Cord Location: Rear left bottom base corner.

### ACCESSORIES (available for purchase at any time)

**IWRM-TRIVET** Black, flexible slip-resistant trivet (locates the chafing dish and protects the stone from heat of pan) **\$118**

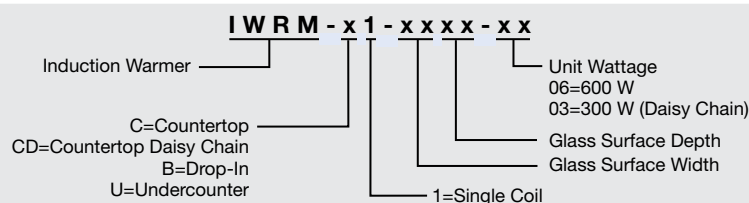

# Light Cooking Equipment

*Supermarkets & Delis • Restaurants & Cafés  
Clubs & Bars • Concessions*



**FWM-1B** pg. 223



**SNACK-2** with accessory Chelky plate pg. 224



**RWM-2B** pg. 225



**SAL-1** with accessory food pan pg. 226

## Flip Waffle Maker

Hatco/Suntec Flip Waffle Makers produce excellent, authentic 1¼" thick, round Belgian waffles. Their unique heating elements and 180° swivel mechanism ensure even cooking, while a thermostatic control and a programmable timer deliver consistent, repeatable results. Adjustments to temperature and time can be made to suit any batter and the unit is memory retentive so you may only have to program it once.

- Commercial food service quality – designed for many hours of continuous use, every day
- Heavy duty stainless steel construction with Teflon® coated aluminum plates
- Simple push-button control panel features a stand-by on/off, timer/temperature toggle, higher/lower selection, and start
- Easy to see bright red LED display shows settings and countdown when cooking
- Timer starts automatically when waffle maker is closed and resets when opened, while a beeper signals the end of a cooking cycle
- Fast initial heat up time, excellent heat retention and recovery delivers high productivity
- Models shipped with NEMA 5-15P plug and cord (attached)

Standard Round Belgian Plate 7"



Mini Round Waffle Plate available as accessory Four 3⅝"



### FLIP WAFFLE MAKER

Model	Item Number	Description	Dimensions (W x D x H)	Voltage	Watts	Amps	Plugs	Approx. Ship Weight	List Price
FWM-1B	FWM1B.515	Round	11⅝" x 22⅞" x 11⅝"	120	1350	11.3	NEMA5-15P	27 lbs.	\$2421

All Hatco/Suntec Flip Waffle Maker Models Feature:

Models Shipped with: cord and plug.

Cord Location: Back of unit, lower left side.

### ACCESSORIES (available for purchase at any time)

WM-BRUSH	Nylon Brush	\$22
WAF-FORK	Waffle Fork	8
MINI-WAFFLE	Mini Waffle Plate	97

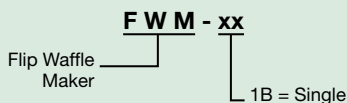

## Snack System

The Hatco/Suntec Snack System will help expand your menu and your sales. With a single or dual electric baker, you can easily switch the interchangeable plates to serve breakfast items, lunch foods and a variety of snacks in between. Freshly bake as many or few items as you need, resulting in no waste at the end of the day. Add more variety to your menu in small quantities and increase sales according to the season, time of day and location.

- Four programmable preset buttons for each cooking cycle. A cooking cycle consists of three different settings:
  - Temperature
  - Time
  - Top Cooking Plate Power
- Adjustable time/temperature controls enable operators to cook continuous, consistent quality products
- One-touch release with latch opener for easy plate replacement
- Exclusive heating elements provide exceptional heat distribution throughout the entire cooking plate, ensuring even cooking of each product
- Removable plates are easily cleaned with warm, soapy water
- Compact design is suitable for any location
- Adjustable temperature allows for multiple menu options

**NOTE:** Comes with standard Round Belgian Waffle Plates and one additional set of plates of your choosing.



SNACK-1 with accessory Chelky plate



SNACK-2 with standard Belgian plate

### SNACK SYSTEM

Model	Item Number	Description	Dimensions (W x D x H)	Voltage	Watts	Amps	Plugs	Approx. Ship Weight	List Price
SNACK-1	SNACK1.515	Single	10 <sup>3</sup> / <sub>8</sub> " x 17 <sup>3</sup> / <sub>8</sub> " x 8 <sup>1</sup> / <sub>8</sub> "	120	900	7.5	NEMA5-15P	23 lbs.	\$1881
SNACK-2	SNACK2.515	Double	21 <sup>1</sup> / <sub>8</sub> " x 17 <sup>3</sup> / <sub>8</sub> " x 8 <sup>1</sup> / <sub>8</sub> "	120	1800	15	NEMA5-15P*	42 lbs.	3047

\* Canadian models use NEMA 6-20P. Item Number is SNACK2.520.

#### All Hatco/Suntec Snack System Models Feature:

**Models Shipped with:** a cleaning brush, tool for switching out plates, standard Round Belgian Waffle Plates and an additional set of plates of your choosing.  
**Cord Location:** Back of unit, bottom left-hand side.

### ACCESSORIES

(available for purchase at any time)

#### Interchangeable Cooking Plates –

<b>FREESTYLE</b>	Freestyle Plates	<b>\$314</b>
<b>BELGIAN</b>	Belgian Plates	<b>314</b>
<b>HEART WAFFLE</b>	Norwegian Waffle Plate	<b>314</b>
<b>COFFEEBEAN</b>	Coffee Bean Plates	<b>314</b>
<b>SANDWICH</b>	Sandwich Plates	<b>314</b>
<b>PANINI</b>	Panini Plates	<b>314</b>
<b>DONUT</b>	Donut Plates	<b>314</b>
<b>CHELKY</b>	Chelky Plates	<b>243</b>
<b>WM-BRUSH</b>	Nylon Brush	<b>\$22</b>

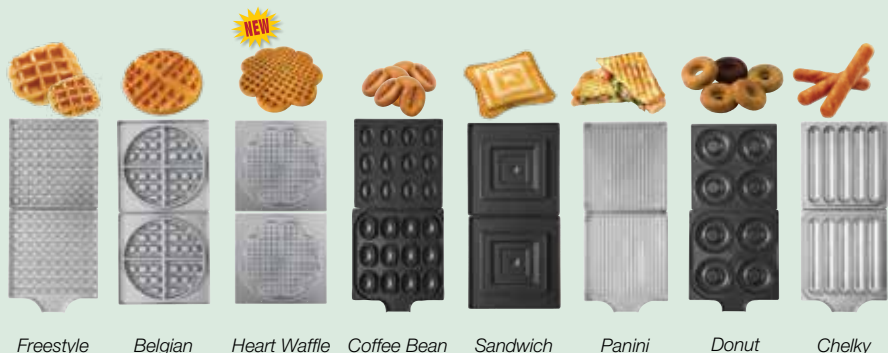

WM-BRUSH accessory

Freestyle

Belgian

Heart Waffle

Coffee Bean

Sandwich

Panini

Donut

Chelky

#### SNACK - x

Snack System ——— | 1 = Single Head  
 | 2 = Dual Head



## Round Waffle Makers

Hatco®/Suntec Round Waffle Makers cook continuous, excellent-quality waffles for commercial kitchens, display cooking locations, and buffets. The adjustable time and temperature controls enable operators to cook consistent quality waffles from a variety of different batters.

- Exclusive heating elements provide exceptional heat distribution throughout the entire cooking plate, ensuring even cooking of each waffle
- Stainless steel frame, cast aluminum cooking plates
- Belgian-style cooking plates produce 1" thick waffles
- LED display shows timer, temperature and status information
- Simple push button control panel featuring a stand-by On/Off, timer/temp toggle, higher/lower selection, and start/stop
- Fast initial heat-up time, excellent heat retention and recovery delivers high productivity and consistent results



RWM-2



RWM-1B

### ROUND WAFFLE MAKERS

Model	Item Number	Description	Dimensions W x D x H	Voltage	Watts	Amps	Plugs	Approx. Ship Weight	List Price
RWM-1	RWM1.515	Single, Round, Standard	9 <sup>5</sup> / <sub>8</sub> " x 17 <sup>3</sup> / <sub>4</sub> " x 8 <sup>1</sup> / <sub>8</sub> "	120	900	7.5	NEMA 5-15P	16 lbs.	<b>\$1109</b>
RWM-1B	RWM1B.515	Single, Round, Belgian	9 <sup>5</sup> / <sub>8</sub> " x 17 <sup>3</sup> / <sub>4</sub> " x 8 <sup>1</sup> / <sub>8</sub> "	120	900	7.5	NEMA 5-15P	16 lbs.	<b>1109</b>
RWM-2	RWM2.515	Double, Round, Standard	19 <sup>5</sup> / <sub>8</sub> " x 17 <sup>3</sup> / <sub>4</sub> " x 8 <sup>1</sup> / <sub>8</sub> "	120	1800	15	NEMA 5-15P *	33 lbs.	<b>1931</b>
RWM-2B	RWM2B.515	Double, Round, Belgian	19 <sup>5</sup> / <sub>8</sub> " x 17 <sup>3</sup> / <sub>4</sub> " x 8 <sup>1</sup> / <sub>8</sub> "	120	1800	15	NEMA 5-15P *	33 lbs.	<b>1931</b>

\* Canadian model uses NEMA 5-20P with different Item Number.

#### All Hatco/Suntec Round Waffle Maker Models Feature:

**Models Shipped with:** Stainless Steel frame and aluminum cooking plates, On/Off power switch, multi-function control panel, removable drip tray, nylon brush and a 6' cord and plug.

**Cord Location:** Back of unit, lower left corner

### ACCESSORY

(available for purchase at any time)

**WM-BRUSH** Nylon Brush **\$22**

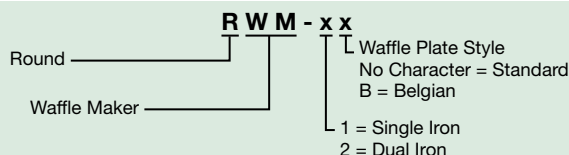



### Electric Salamander

Hatco's Electric Salamander gives you versatility in the kitchen with the capability to cook, grill, reheat and keep foods hot. The plate detection feature activates the instant-on heating elements automatically when a food plate comes into contact with the plate detection bar.

- Three independently-controlled Instant-On heating elements provide the benefits of on-demand cooking and energy conservation
- Adjustable upper housing gives 4½" of vertical movement for maximum versatility
- Features high-powered infrared ribbon heating elements
- Heating elements are on only when a cook or hold cycle has been activated, eliminating residual heat in the kitchen environment
- The HOLD function has eight programmable heat levels and is ideal for keeping food hot or for reheating food
- Features a flat, touch control panel and stainless steel construction



#### ELECTRIC SALAMANDER

Model	Dimensions W x D x H ‡	Cooking Area W x D	Voltage Single Phase	Watts	Amps	Plug	Approx. Ship Weight	List Price
SAL-1	22¾" x 21¾" x 23⅞"	21⅞" x 13¾"	208	4500	21.6	NEMA 6-30P	143 lbs.	<b>\$8006</b>
SAL-1	22¾" x 21¾" x 23⅞"	21⅞" x 13¾"	240	4500	18.8	NEMA 6-30P	143 lbs.	<b>8006</b>

‡ Height includes 4" legs. Add 2" to depth for wall mounted units.

#### All Electric Salamander Models Feature:

Models Shipped with: Cooking grate, drip pan, wall mounting hardware, 4" adjustable black plastic legs and cord & plug.

Power Inlet Location: Back of unit, lower right corner.

#### OPTIONS (available at time of purchase only)

SAL-HW Hardwiring (in lieu of standard 4' Cord and Plug) **No Charge**

**FOOD PANS AND TRIVETS – PAGE 245**

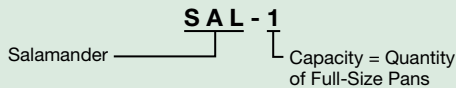

**Saves Energy,  
Saves Money,  
Protects your Reputation!**

Do your bit for Global Warming with Hatco's SAL-1. The Hatco Electric Salamander's elements are ready for use in just eight seconds. How does that work? Mounted on the back wall of the Salamander is a "plate detection" switch that keeps the unit from turning on unless a plate or pan is put underneath, against this bar. That means the elements are only on when they need to be. Most kitchens have every piece of equipment on all day, firing out heat and constantly using energy. Even in power save mode, most equipment is never fully off. Not the Electric Salamander. It's 100% off when not in use, saving money, energy and the environment.

# Water Heating/ Specialty Equipment

*Cafeterias • Convenience Stores  
Supermarkets & Delis • Restaurants & Cafés  
Clubs & Bars • Catering • Concessions*



**3CS-9B** with optional temperature monitor  
*pg. 229*



**FR-9** *pg. 231*



**PMG-100** *pg. 233*



**PMG-200** with optional Stainless Steel body  
and base, and accessory Stainless Steel  
legs *pg. 233*



**C-27** *pg. 235*



**S-57** with optional Stainless Steel body and base,  
and accessory Stainless Steel legs *pg. 237*



July 1, 2024

## Atmospheric Hot Water Dispenser

At a simple push of a button, the Hatco Atmospheric Hot Water Dispenser delivers pre-measured quantities of hot water for food preparation or cleaning. The compact, durable design uses minimal counter space, while providing up to 8 gallons of continuous hot water. The removable shelf allows access to dispense water into larger containers.

- Quickly delivers 2, 3 or 4 quarts of hot water with the touch of a button
- Program can be interrupted for versatility and convenience
- Manual dispense button for additional water volume options
- 12 gallon stainless steel tank is emptied easily with convenient bottom drain
- Hot water ready in as little as 15 minutes



AWD-12 Pitcher not available

### ATMOSPHERIC HOT WATER DISPENSER

Model	Dimensions W x D x H ‡	kW	Voltage	Phase	Plug	Approx. Ship Weight	List Price
AWD-12	13¾" x 27½" x 28½"	5.0	208 or 240	1	NEMA 6-30P	105 lbs.	\$6443

‡ Height includes 4" legs.

#### All Hot Water Dispenser Models Feature:

Models Shipped with: Low-water cut-off (LWCO), high temperature limit, electronic temperature controller and digital temperature display.

Distance Between Shelf and Spout: 11¾".

Cord Location: Lower left corner on left side.

### WATER QUALITY REQUIREMENTS – PAGE 247

#### WATER TEMPERATURE RECOVERY TABLE

Degrees of Rise										
60°F (33°C)	70°F (39°C)	80°F (44°C)	90°F (50°C)	100°F (55°C)	110°F (61°C)	120°F (66°C)	130°F (72°C)	140°F (78°C)	150°F (83°C)	160°F (88°C)
33 gph (125 lph)	29 gph (110 lph)	25 gph (95 lph)	22 gph (83 lph)	20 gph (75 lph)	18 gph (68 lph)	17 gph (64 lph)	15 gph (57 lph)	14 gph (53 lph)	13 gph (49 lph)	12 gph (45 lph)

gph = gallons per hour  
lph = liters per hour

#### COLD-START HEAT-UP TIME

Degrees of Rise		
60°F (33°C)	90°F (50°C)	140°F (78°C)
22 Minutes	33 Minutes	52 Minutes

#### WATER TEMPERATURE RECOVERY TIME

Degrees of Rise		
60°F (33°C)	90°F (50°C)	140°F (78°C)
15 Minutes*	22 Minutes*	35 Minutes*

\* Recovery times are after 10 gallons (37 liters) of water have been dispensed

#### OPTIONS (available at time of purchase only)

WALLMOUNT	Wall-Mounting Shelf	\$551
AWD-L6	NEMA L6-30P Locking Cap in lieu of NEMA 6-30P	add 22

#### ACCESSORIES (available for purchase at any time)

AWD-FILTER	Water Filtration Cartridge for premium quality water (recommended filter change every 15,000 gallons) – Incoming water must be 100°F or less	\$592
AWD-PLUMB	3' Rubber Drain Hose with 10' ¼" Inlet Tubing	92



**AWD-FILTER** Accessory  
Provides a superior balance of chlorine, taste, and odor reduction. Inhibits limescale build-up

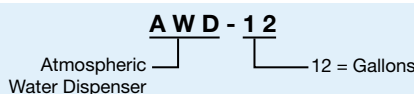



## 3CS Sanitizing Sink Heaters

Maintaining a continuous supply of sanitizing rinse water without taking up valuable space, the 3CS makes manual warewashing faster and more convenient. Drain may be plumbed to open-sight waste drain. A special 3CS Sink Heater is available for shipboard use under military spec (MiL-H-43895B) – consult factory for prices.

- Stainless steel front, powdercoated silver-gray hammertone body and convenient side drain
- Equipped with an Energy Cut-Off (ECO) for built-in protection against higher-than-normal water temperature
- An On/Off toggle switch with indicator light to indicate power status, and a red light to indicate the need to refill and reset the unit
- Meets NSF standard of 180°F for dish sanitizing



3CS-9 with optional temperature monitor

### SANITIZING SINK HEATERS

Model	kW	Sink Area	Voltage	Phase	Approx. Ship Weight	List Price	
						208 or 240V	480V
3CS-3	3.0	15" Sq. or less	208, 240, 480	1	24 lbs.	\$3031	\$3143
3CS-4	4.5	16"-18" Sq.	208, 240, 480	1	24 lbs.	3051	3163
3CS-6 <sup>Δ</sup>	6.0	19"-21" Sq.	208, 240, 480	1 or 3	26 lbs.	3111	3223
3CS-9 <sup>Δ</sup>	9.0	21"-25" Sq.	208, 240, 480	1 or 3	27 lbs.	3221	3333
3CS-3B	3.0	15" Sq. or less	208, 240, 480	Balanced 3	30 lbs.	3451	3563
3CS-4B	4.5	16"-18" Sq.	208, 240, 480	Balanced 3	30 lbs.	3451	3563
3CS-6B	6.0	19"-21" Sq.	208, 240, 480	Balanced 3	30 lbs.	3451	3563
3CS-9B	9.0	21"-25" Sq.	208, 240, 480	Balanced 3	33 lbs.	3451	3563

<sup>Δ</sup> Open delta on 3-phase. Larger circuit required than for balanced 3-phase of equal kW.

**All Sink Heater Models Feature:**

Dimensions 3CS-3, -4, -6, -9: 6¾"W x 16⅞"D x 12⅝"H.

3CS-9 480V, 3CS-3B, -4B, -6B, -9B: 8"W x 17⅞"D x 12⅝"H.

Models Shipped with: Stainless steel front, silver gray hammertone body and black base.

3CS Heaters can be shipped FED-EX GROUND or United Parcel Service.

### WATER QUALITY REQUIREMENTS – PAGE 247

#### OPTIONS (available at time of purchase only)

SSBB	All Stainless Steel Body and Base	\$142
TEMP MON*	Temperature Monitor (Built-In)	146
TEMP LIGHT*	Temperature Light	111
CSA-WIRE	CSA Wiring (Canadian models only)	74
FR-SECURITY	Security Package (Torx® Screws and Control Cover)	214
MIL-H-43895B	Shipboard use	Consult Factory for Pricing

#### ACCESSORIES (available for purchase at any time)

FR-FLUSH	Flush Hose, Stopper and Adapter	\$96
----------	---------------------------------	------

\* Specify either monitor or light, not both.



FR-FLUSH Accessory

#### SIZING INFORMATION

For a Sink Heater: 2000 WATTS PER SQUARE FOOT of vessel top.

3CS Sink Heaters are sized based on 140°F supply water with a 30 minute preheat period to reach the sanitizing temperature. Sink Heaters are mounted into the third compartment sink with standard plumbing fittings provided. Two 2" diameter holes are required for these fittings and a full size template is provided to locate holes in the sink. The 3CS Sink Heater is easily attached to the plumbing fittings with self-contained unions.

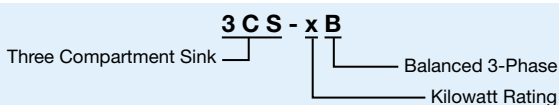
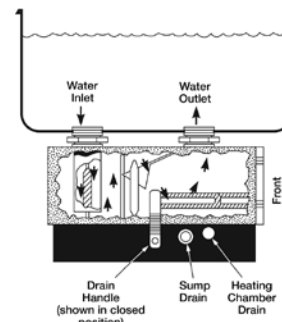



July 1, 2024

## 3CS2 Hydro-Heater Sanitizing Sink Heaters

The patented Hatco 3CS2 Hydro-Heater concept features a tubular water chamber with heating elements uniquely wrapped outside the flow tube so elements do not come in contact with the water, eliminating sediment and lime buildup, resulting in longer life. An electronic controller with digital display maintains an accurate setpoint temperature.

- Utilizes “free-flow” technology and advanced electronic controls to assure responsive and efficient operation
- Stainless steel front, powdercoated body, convenient drain outlet and clean-out caps



**3CS2-3**  
with optional  
auto-fill solenoid

### SANITIZING SINK HEATERS

Model	kW	Dimensions W x D x H	Sink Area	Voltage	Phase	Approx. Ship Weight	List Price
3CS2-3	3	7 <sup>3</sup> / <sub>4</sub> " x 17 <sup>1</sup> / <sub>8</sub> " x 12 <sup>3</sup> / <sub>8</sub> "	15" Sq. or less	208	1	31 lbs.	<b>\$3641</b>
3CS2-4	4	7 <sup>3</sup> / <sub>4</sub> " x 17 <sup>1</sup> / <sub>8</sub> " x 12 <sup>3</sup> / <sub>8</sub> "	16"-18" Sq.	208, 240	1	31 lbs.	<b>3676</b>
3CS2-6	6	7 <sup>3</sup> / <sub>4</sub> " x 17 <sup>1</sup> / <sub>8</sub> " x 12 <sup>3</sup> / <sub>8</sub> "	19"-21" Sq.	208	1	31 lbs.	<b>3946</b>
3CS2-3B	3	7 <sup>3</sup> / <sub>4</sub> " x 17 <sup>1</sup> / <sub>8</sub> " x 12 <sup>3</sup> / <sub>8</sub> "	15" Sq. or less	208, 240	Balanced 3	35 lbs.	<b>4086</b>
3CS2-4B	4	7 <sup>3</sup> / <sub>4</sub> " x 17 <sup>1</sup> / <sub>8</sub> " x 12 <sup>3</sup> / <sub>8</sub> "	16"-18" Sq.	208, 240	Balanced 3	35 lbs.	<b>4086</b>
3CS2-6B	6	7 <sup>3</sup> / <sub>4</sub> " x 17 <sup>1</sup> / <sub>8</sub> " x 12 <sup>3</sup> / <sub>8</sub> "	19"-21" Sq.	208, 240	Balanced 3	35 lbs.	<b>4086</b>
3CS2-9B	9	7 <sup>3</sup> / <sub>4</sub> " x 17 <sup>1</sup> / <sub>8</sub> " x 12 <sup>3</sup> / <sub>8</sub> "	21"-25" Sq.	208	Balanced 3	35 lbs.	<b>4086</b>

**All Sink Heater Models Feature:**

Models Shipped with: Stainless steel front, powdercoated body, low-water cut-off (LWCO) and electronic temperature monitor.  
3CS2 Heaters can be shipped FED-EX GROUND or United Parcel Service.

**WATER QUALITY REQUIREMENTS – PAGE 247**

**OPTIONS** (available at time of purchase only)

SSBODY	All Stainless Steel Body and Base	<b>\$142</b>
AUTOFILL	Auto-fill Solenoid	<b>428</b>
REMOTE	Remote Mounted Control	<b>343</b>
HH-SECURITY	Security Package (Torx® Screws and Control Cover)	<b>214</b>



**FR2-FLUSH** Accessory

**ACCESSORIES** (available for purchase at any time)

FR2-FLUSH	Flush Hose, Cleaning Brush, Stopper and Adapter	<b>\$113</b>
-----------	---	--------------

**SIZING INFORMATION**

For a Sink Heater: 2000 WATTS PER SQUARE FOOT of vessel top.

3CS2 Sink Heaters are sized based on 140°F supply water with a 30 minute preheat period to reach the sanitizing temperature. Sink Heaters are mounted in the center of the third compartment sink with standard plumbing fittings provided. Two 2" diameter holes are required for these fittings and a full size template is provided to locate holes in the sink. The 3CS2 Sink Heater is easily attached to the plumbing fittings with self-contained unions.

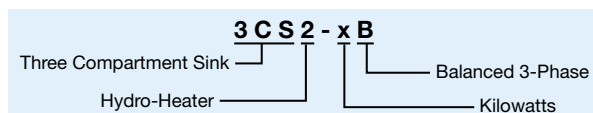

## FR Food Rethermalizer/ Bain-Marie Heaters

The Hatco FR is a Bain-Marie or food reconstitutor to heat or hold foods at safe temperatures between 140° and 190°F. All models are shipped factory assembled, pre-wired and include standard 2" stainless steel plumbing fittings for mounting into a holding tank. Drain may be plumbed to open-sight waste drain.

- Equipped with an Energy Cut-Off (ECO) for built-in protection against higher-than-normal water temperature
- Stainless steel tank with five year limited warranty
- Optional low-water cut-off (LWCO) available to prevent element burn out from low-water conditions
- Separate sump and heating compartment drains for cleaning and sanitizing



FR-9

### FOOD RETHERMALIZER/BAIN-MARIE HEATERS

Model	kW	Voltage	Phase	Approx. Ship Weight	List Price	
					208 or 240V	480V
FR-3	3.0	208, 240, 480	1	24 lbs.	\$2776	\$2888
FR-4	4.5	208, 240, 480	1	24 lbs.	2811	2923
FR-6 <sup>Δ</sup>	6.0	208, 240, 480	1 or 3	28 lbs.	3101	3213
FR-9 <sup>Δ</sup>	9.0	208, 240, 480	1 or 3	28 lbs.	3176	3288
FR-3B	3.0	208, 240, 480	Balanced 3	30 lbs.	3396	3508
FR-4B	4.5	208, 240, 480	Balanced 3	32 lbs.	3396	3508
FR-6B	6.8	208, 240, 480	Balanced 3	30 lbs.	3396	3508
FR-9B	9.0	208, 240, 480	Balanced 3	30 lbs.	3396	3508

<sup>Δ</sup> Open delta on 3-phase. Larger circuit required than for balanced 3-phase of equal kW.

**All Food Rethermalizer Models Feature:**

Dimensions: FR-3, -4, -6, -9: 6¾"W x 16⅞"D x 12¼"H.

FR Models with 480V and Low Water Cut-Off: 8"W x 17⅞"D x 12¼"H.

FR-3B, -4B, -6B, -9B: 8"W x 17⅞"D x 12¼"H.

Models Shipped with: Stainless steel front, silver gray hammertone body and black base. FR Heaters can be shipped FED-EX GROUND or United Parcel Service.

### WATER QUALITY REQUIREMENTS – PAGE 247

#### OPTIONS (available at time of purchase only)

SSBB	All Stainless Steel Body and Base	\$142
W/LW	Low-Water Cut-Off	238
CSA-WIRE	CSA Wiring (Canadian models only – not available with Cord and Plug)	74
FR-SECURITY	Security Package (Torx® Screws and Control Cover)	214

#### ACCESSORIES (available for purchase at any time)

FR-FLUSH	Flush Hose, Stopper and Adapter	\$96
----------	---------------------------------	------



FR-FLUSH Accessory

#### SIZING INFORMATION

For a Bain-Marie or steam table: MINIMUM 750 WATTS PER SQUARE FOOT of vessel top.

For a Food Rethermalizer: MINIMUM 2000 WATTS PER SQUARE FOOT of vessel top.

Use one FR for a Bain-Marie up to 6' long. Units over 6' require a minimum of two FRs. (Tank Baffle supplied by installer.)

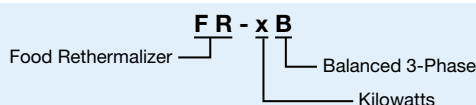
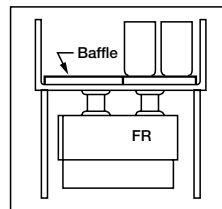



July 1, 2024

## FR2 Hydro-Heater Food Rethernalizer/ Bain-Marie Heaters

The patented Hatco FR2 Hydro-Heater concept features a tubular water chamber with heating elements uniquely wrapped outside the flow tube so elements do not come in contact with the water, eliminating sediment and lime buildup, resulting in longer life. An electronic controller with digital display maintains an accurate setpoint temperature.

- Utilizes “free-flow” technology and advanced electronic controls to assure responsive and efficient operation
- Stainless steel front, powdercoated body, convenient drain outlet and clean-out caps



FR2-3 with optional  
Stainless Steel body and base

### FOOD RETHERMALIZER/BAIN-MARIE HEATERS

Model	Dimensions W x D x H	kW	Voltage 50/60Hz	Phase	Approx. Ship Weight	List Price
FR2-3	7 <sup>3</sup> / <sub>4</sub> " x 17 <sup>1</sup> / <sub>8</sub> " x 12 <sup>3</sup> / <sub>8</sub> "	3	208	1	34 lbs.	<b>\$3636</b>
FR2-4	7 <sup>3</sup> / <sub>4</sub> " x 17 <sup>1</sup> / <sub>8</sub> " x 12 <sup>3</sup> / <sub>8</sub> "	4	208, 240	1	34 lbs.	<b>3676</b>
FR2-6	7 <sup>3</sup> / <sub>4</sub> " x 17 <sup>1</sup> / <sub>8</sub> " x 12 <sup>3</sup> / <sub>8</sub> "	6	208	1	34 lbs.	<b>3926</b>
FR2-3B	7 <sup>3</sup> / <sub>4</sub> " x 17 <sup>1</sup> / <sub>8</sub> " x 12 <sup>3</sup> / <sub>8</sub> "	3	208, 240	Balanced 3	34 lbs.	<b>4081</b>
FR2-4B	7 <sup>3</sup> / <sub>4</sub> " x 17 <sup>1</sup> / <sub>8</sub> " x 12 <sup>3</sup> / <sub>8</sub> "	4	208, 240	Balanced 3	34 lbs.	<b>4081</b>
FR2-6B	7 <sup>3</sup> / <sub>4</sub> " x 17 <sup>1</sup> / <sub>8</sub> " x 12 <sup>3</sup> / <sub>8</sub> "	6	208, 240	Balanced 3	34 lbs.	<b>4081</b>
FR2-9B	7 <sup>3</sup> / <sub>4</sub> " x 17 <sup>1</sup> / <sub>8</sub> " x 12 <sup>3</sup> / <sub>8</sub> "	9	208	Balanced 3	34 lbs.	<b>4081</b>

**All Food Rethernalizer Models Feature:**

Models Shipped with: Stainless steel front, powdercoated body, low-water cut-off (LWCO) and electronic temperature monitor.  
FR2 Heaters can be shipped FED-EX GROUND or United Parcel Service.

### WATER QUALITY REQUIREMENTS – PAGE 247

#### OPTIONS (available at time of purchase only)

SSBODY	All Stainless Steel Body and Base	<b>\$142</b>
AUTOFILL	Auto-fill Solenoid	<b>428</b>
REMOTE	Remote Mounted Control	<b>343</b>
HH-SECURITY	Security Package (Torx® Screws and Control Cover)	<b>214</b>

#### ACCESSORIES (available for purchase at any time)

FR2-FLUSH	Flush Hose, Cleaning Brush, Stopper and Adapter	<b>\$113</b>
-----------	---	--------------



FR2-FLUSH Accessory

#### SIZING INFORMATION

For a Bain-Marie or steam table: MINIMUM 750 WATTS PER SQUARE FOOT of vessel top.

For a Food Rethernalizer: MINIMUM 2000 WATTS PER SQUARE FOOT of vessel top.  
Use one FR2 for a Bain-Marie up to 6' long. Over 6', minimum two required.

MUST BE INSTALLED WITH A PERFORATED WATER BAFFLE. This baffle is not supplied with heater. The FR2 should be positioned with no more than 3' on either side when mounted in holding vessel. Consult factory or installation manual for fabricating details.

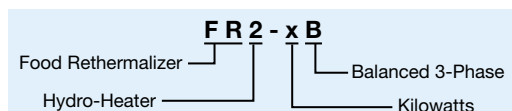



## Powermite® Gas Booster Water Heaters

The Powermite® Gas Booster Water Heater provides 180°F sanitizing hot water and long life dependability. Models can be supplied to operate on either natural or propane gas and feature a burner system that utilizes both primary and secondary air for consistent ignition. Available for U.S. and Canada only.

- Features stainless steel tanks – front and top, powdercoated sides and back, finned tube copper heat exchanger, temperature relief valve, pressure reducing valve, two temperature/pressure gauges, blended phosphate water treatment system, shock absorber and low-water cut-off (LWCO)
- Spark to light with standing pilot
- PMG-100 has 3 tube type burners, and PMG-200 has 6 tube type burners



PMG-100

### GAS BOOSTER WATER HEATERS

Model	Input BTUs/Hour	Output	Dimensions W x D x H ‡	Approx. Ship Weight	List Price
PMG-100	105,000	84,800 = 24.8kW	27½" x 20¾" x 31"	193 lbs.	<b>\$18236</b>
PMG-200	195,000	156,000 = 45.7kW	36" x 20¾" x 31"	228 lbs.	<b>21631</b>

‡ Height includes legs. Width & depth does not include temperature pressure relief valve dimensions.

#### All Gas Booster Water Heater Models Feature:

Electrical Supply: 120 VAC, 360 watt, 3.00 amp.

Connections: Gas – ¾" NPT, Water – ¾" NPT, Electric – 120 VAC, 15 amp.

Fuel: Standard – Natural gas. Optional – Propane gas.

Models Shipped with: Stainless steel tank/front/top, powdercoated sides and back, blended phosphate water treatment system, low-water cut-off (LWCO), temperature/pressure relief valve, pressure reducing valve, shock absorber, two temperature/pressure gauges, indicator light and On/Off switch.

Water Capacity: 4¾ gallons.

Natural Gas Inlet Pressure Inches Water Column: Min. – 5.0. Max. – 10.5.

Propane/LP Gas Inlet Pressure Inches Water Column: Min. – 11.0. Max. – 13.0.

Operating Pressure Specifications at Manifold –

Inches Water Column at Pressure Tap: Natural Gas – 3.5. Propane/LP Gas – 10.0.

Direct Fluing: Combustion air enters bottom, flue gasses exit right side or back at top of unit.

Vent^: Forced draft system with 4" diameter vent pipe adapter.

^ Before installing any method of venting contact the local code authority or gas supplier to make sure the final installation will be acceptable to the authorities who have jurisdiction. See Installation Manual at [www.hatcocorp.com](http://www.hatcocorp.com) for more venting information.

NOTE: Pages 241-243 for sizing information.

### WATER QUALITY REQUIREMENTS – PAGE 247

#### OPTIONS (available at time of purchase only)

##### Stainless Steel Body and Base –

SSBB	PMG-100	<b>\$300</b>
SSBB	PMG-200	<b>364</b>
PMG-SECURITY	Security Package (Torx® Screws and Control Cover)	<b>\$218</b>

#### ACCESSORIES (available for purchase at any time)

QSFLOORMOUNT	Additional Stainless Steel Floor Mounting Leg Assembly	<b>\$408</b>
QSBPRV	Back Pressure Relief Valve (page 239 for illustration)	<b>235</b>
QSPRVB	Additional Brass Pressure Reducing Valve with Bypass	<b>230</b>
QSSSA-LEGS	Additional Stainless Steel Adjustable Legs (6"-7")	<b>262</b>
PMG-AI	Air Interlock Switch	<b>233</b>
ORIF	High Altitude Kit for gas and elevation – applicable at 2000 feet and above (PMG-200 only)	<b>No Charge</b>

NOTE: 6" plastic adjustable legs (6"-7") standard. Description of accessories is shown on page 239.



PMG-AI  
Accessory



ORIF Accessory

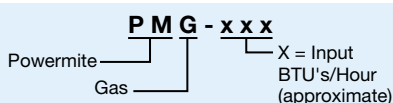



July 1, 2024

## Mini-Compact Electric Booster Water Heaters

The Mini-Compact specialty heater features a stainless steel tank and fast recovery, making it ideal for hot water sanitizing. This heater includes stainless steel front with powdercoated silver gray hammertone body, black base, 6" legs and a storage capacity of 3.2 gallons.

- Provides 180°F water for hot water sanitizing
- Features temperature/pressure relief valve, a pressure reducing valve, two temperature/pressure gauges, a high-temperature limit control and a low-water cut-off (LWCO)



MC-10

### SPECIALTY ELECTRIC BOOSTER WATER HEATERS

Model	Dimensions (W x D x H †)	kW	Voltage	Phase	Approx. Ship Weight	List Price	
						208 or 240V	480V
MC-10 <sup>⚡</sup>	11¾" x 12⅞" x 18½"	9.9	208	1, 3	48 lbs.	<b>\$3951</b>	—
MC-11 <sup>⚡</sup>	11¾" x 12⅞" x 18½"	11.4	240 480	1, 3 3	48 lbs.	<b>3951</b>	<b>\$4007</b>
MC-15	11¾" x 12⅞" x 18½"	15	208	3	49 lbs.	<b>4276</b>	—
MC-17	11¾" x 12⅞" x 18½"	17.25	208	3	48 lbs.	<b>4321</b>	—

⚡ Must specify phase. Not field-convertible.

† Height includes 6" (152 mm) legs.

#### All Specialty Electric Booster Water Heater Models Feature:

Models Shipped with: Low-water cut-off (LWCO), temperature/pressure relief valve, pressure reducing valve and two temperature/pressure gauges.

### WATER QUALITY REQUIREMENTS – PAGE 247

#### OPTIONS (available at time of purchase only)

MCL-SSJA	Stainless Steel Body and Base	<b>\$164</b>
----------	-------------------------------	--------------

#### ACCESSORIES (available for purchase at any time)

✓ QSWATERTREAT	Blended Phosphate Injection System – not for potable water use (page 239 for illustration)	<b>\$1053</b>
✓ QSSHOCK	Shock Absorber to reduce water hammer	<b>150</b>
✓ QSPRVB	Additional Brass Pressure Reducing Valve	<b>230</b>
✓ QSSSA-LEGS	Additional Stainless Steel Adjustable Legs (6"-7")	<b>262</b>

NOTE: 6" plastic adjustable legs (6"-7") standard. Description of accessories is shown on page 239.

MC - x x

Mini-Compact ——— Kilowatts

## Compact Electric Booster Water Heaters

Compact models provide all the 180°F final rinse water to sanitize and flash-dry dishes and flatware. Models include stainless steel front panel, silver gray hammertone body, black base and standard 6" plastic legs. Slide brackets for mounting under a dishtable are available. The Castone® lined tank is standard on all models and has a six gallon capacity.

- The Compact Electric Booster is easy to install next to a dishwasher to save space, either on 6" plastic legs or with accessory slide brackets
- All models include a Castone® lined tank with a 10-year limited warranty, and fiberglass insulation to minimize heat loss
- Swing-away front panels with low-water cut-off (LWCO), control fuses and transformer allow quick access to probes and elements, for easier serviceability



C-18 with optional Stainless Steel body and base



C-45

**NOTE:** Single phase is uncommon in heaters 24kW and larger and are NOT returnable.

### COMPACT ELECTRIC BOOSTER WATER HEATERS

Model	kW	208V		240V		480V		Approx. Ship Weight	List Prices	
		Single Ph	Single Ph	Three Ph	Three Ph	Three Ph	Three Ph		208 or 240V	480V
<b>Small</b>										
C-4	4			—	—	—	—	115 lbs.	\$4176	\$4176
C-5	5			—	—	—	—	115 lbs.	4231	4231
C-6	6							118 lbs.	4306	4306
C-7	7							118 lbs.	4366	4366
C-9	9							118 lbs.	4411	4411
C-12	12							120 lbs.	4666	4666
C-13	13.5							120 lbs.	4701	4701
C-15	15							120 lbs.	4761	4761
C-17	17.25	—	—			—	—	120 lbs.	4791	—
C-18	18			—				120 lbs.	4831	4831
<b>Large</b>										
C-24	24							142 lbs.	\$6426	\$6426
C-27	27							142 lbs.	6526	6526
C-30	30							142 lbs.	6586	6586
C-36	36							142 lbs.	6886	6806
C-39	39							142 lbs.	7011	6926
C-45	45	—						142 lbs.	7801	7711
C-54	54	—	—					142 lbs.	8016	7921
C-57	57	—	—					142 lbs.	8176	8076

⚡ Only 6, 7 & 9kW models can be field converted to single phase (units are shipped 3-phase open delta). Larger branch circuit required than for balanced 3-phase of equal kW. (Balanced 3-phase available in 4-6 & 9kW models, consult factory.) 208 and 240 volt only.  
 ⚡ 480V available in single phase only.  
 Contact factory if Balanced 3 Ph is required.

**All Compact Electric Booster Water Heater Models Feature:**

**Voltage:** 208, 240 and 480.  
**Dimensions: Models C-4 through C-18:** 13"W x 20 3/4"D x 19 1/4"H. Add 5/4" to depth for temperature/pressure relief valve. Height includes legs.  
**Models C-24 through C-57:** 18"W x 24"D x 18"H. Add 6 1/2" to depth for temperature/pressure relief valve. Height includes legs.

**Models Shipped with:** Castone® tank, low-water cut-off (LWCO), temperature/pressure relief valve, pressure reducing valve, two temperature/pressure gauges, 6" black plastic non-adjustable legs, indicator light and On/Off switch.

**Compact Booster Water Heaters are not recommended for shipment via FED-EX GROUND or United Parcel Service.**

**NOTE:** Pages 241-243 for sizing information.

**NOTE:** Consult page 244 for proper breaker size. Verify amperage load for Booster Heaters 24kW through 57kW in single phase. Because of excessively high amps and since these units are NOT field convertible to any other voltage or phase, written confirmation is required before processing can begin.

**OPTIONS AND ACCESSORIES – PAGE 236**  
**LOW-TEMP DISHWASHERS – SEE LOW-TEMP SIZING DATA ON PAGE 240**  
**WATER QUALITY REQUIREMENTS – PAGE 247**

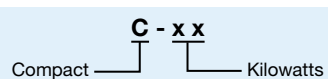



July 1, 2024



**C-27** with accessory slide brackets

**OPTIONS** (available at time of purchase only)

<b>SSBB</b>	Stainless Steel Body and Base	<b>No Charge</b>
<b>C-SECURITY</b>	Security Package (Torx® Screws and Control Cover)	<b>\$222</b>

**ACCESSORIES** (available for purchase at any time)

<b>QSFLOORMOUNT</b>	Additional Stainless Steel Floor Mounting Leg Assembly	<b>\$ 408</b>
<b>QSWATERTREAT</b>	Blended Phosphate Injection System – not for potable water use (page 239 for illustration)	<b>1053</b>
<b>QSSHOCK</b>	Shock Absorber to reduce water hammer	<b>150</b>
<b>QSBPRV</b>	Back Pressure Relief Valve	<b>235</b>
<b>QSPRVB</b>	Additional Brass Pressure Reducing Valve with Bypass	<b>230</b>
<b>QSSSA-LEGS</b>	Additional Stainless Steel Adjustable Legs (6"-7")	<b>262</b>
<b>QSBOSTERBRKT</b>	Additional Slide Brackets	<b>92</b>

**NOTE:** 6" plastic adjustable legs (6"-7") standard. Description of accessories is shown on page 239.

**WATER TEMPERATURE RECOVERY TABLE**

Compact Model	40°F Rise	70°F Rise	Compact Model	40°F Rise	70°F Rise
<b>C-4</b>	40 gph	23 gph	<b>C-18</b>	181 gph	103 gph
<b>C-5</b>	50 gph	29 gph	<b>C-24</b>	241 gph	138 gph
<b>C-6</b>	60 gph	34 gph	<b>C-27</b>	271 gph	155 gph
<b>C-7</b>	70 gph	40 gph	<b>C-30</b>	301 gph	172 gph
<b>C-9</b>	90 gph	52 gph	<b>C-36</b>	361 gph	206 gph
<b>C-12</b>	120 gph	69 gph	<b>C-39</b>	391 gph	224 gph
<b>C-13</b>	135 gph	77 gph	<b>C-45</b>	452 gph	258 gph
<b>C-15</b>	151 gph	86 gph	<b>C-54</b>	542 gph	310 gph
<b>C-17</b>	173 gph	99 gph	<b>C-57</b>	573 gph	326 gph

**NOTE:** gph is "gallons per hour."



## Imperial Electric Booster Water Heaters

Imperial Booster Water Heaters combine quality construction and rugged dependability to provide up to 573 gph of 180°F sanitizing rinse water. Models include stainless steel front panel, silver gray hammertone body, black base, standard 6" legs, Castone® lined tank and have a 16-gallon capacity.

- All models include a Castone® lined tank with a 10-year limited warranty
- Features temperature/pressure relief valve, two temperature gauges, a high-temperature limit control, pilot indicator light, On/Off switch and a low-water cut-off (LWCO) to prevent element burnout due to low water conditions
- Built-in heat trap and fiberglass insulation minimizes heat loss
- Stainless steel front panel and powdercoated silver-gray hammertone body is standard on all Imperial models



S-54

**NOTE:** Single phase is uncommon in heaters 24kW and larger and are NOT returnable.

### IMPERIAL ELECTRIC BOOSTER WATER HEATERS

Model	kW	Voltage			Approx. Ship Weight	List Prices		
		208V Single Ph	240V Single Ph	208V Three Ph		240V Three Ph	208 or 240V	480V
<b>Small</b>								
S-6	6				200 lbs.	\$6051	\$6051	
S-7	7				200 lbs.	6136	6136	
S-9	9				200 lbs.	6176	6176	
S-12	12				200 lbs.	6526	6526	
S-13	13.5				200 lbs.	6536	6536	
S-15	15				200 lbs.	6586	6586	
S-17	17.25	—	—	—	200 lbs.	6621	—	
S-18	18			—	200 lbs.	6666	6666	
<b>Large</b>								
S-24	24				214 lbs.	\$7621	\$7621	
S-27	27				214 lbs.	7676	7676	
S-30	30				214 lbs.	7786	7786	
S-36	36				214 lbs.	8341	8306	
S-39	39				214 lbs.	8441	8401	
S-40	40.5	—	—		224 lbs.	8721	8676	
S-45	45	—	—		224 lbs.	8856	8806	
S-54	54	—	—		224 lbs.	8881	8826	
S-57	57	—	—		224 lbs.	9036	8976	

⚡ Only 6, 7 & 9kW models can be field converted to single phase (units are shipped 3-phase open delta). Larger branch circuit required than for balanced 3-phase of equal kW. (Balanced 3-phase available in 6 & 9kW models, consult factory.) 208 and 240V only.

**All Imperial Electric Booster Water Heater Models Feature:**

**Voltage:** 208, 240 and 480.

**Dimensions:** 23 3/8"W x 22 3/4"D x 31 1/8"H. Add 5" to width for temperature/pressure relief valve. Height includes legs.

**Models Shipped with:** Castone® tank, low-water cut-off (LWCO), temperature/pressure relief valve, pressure reducing valve, two temperature/pressure gauges, indicator light and On/Off switch.

**NOTE:** Pages 241-243 for sizing information.

**NOTE:** Consult page 244 for proper breaker size. Verify amperage load for Booster Heaters 24kW through 57kW in single phase. Because of excessively high amps and since these units are NOT field convertible to any other voltage or phase, written confirmation is required before processing can begin.

**OPTIONS AND ACCESSORIES – PAGE 238**  
**LOW-TEMP DISHWASHERS – SEE LOW-TEMP SIZING DATA ON PAGE 240**  
**WATER QUALITY REQUIREMENTS – PAGE 247**

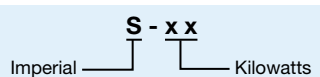



July 1, 2024



S-57 with optional Stainless Steel body and base, and accessory Stainless Steel legs

**OPTIONS** (available at time of purchase only)

<b>SSBB</b>	Stainless Steel Body and Base	<b>No Charge</b>
<b>S-SECURITY</b>	Security Package (Torx® Screws and Control Cover)	<b>\$222</b>

**ACCESSORIES** (available for purchase at any time)

<b>QSFLOORMOUNT</b>	Additional Stainless Steel Floor Mounting Leg Assembly	<b>\$ 408</b>
<b>QSWATERTREAT</b>	Blended Phosphate Injection System – not for potable water use (page 239 for illustration)	<b>1053</b>
<b>QSSHOCK</b>	Shock Absorber to reduce water hammer	<b>150</b>
<b>QSBPRV</b>	Back Pressure Relief Valve	<b>235</b>
<b>QSPRVB</b>	Additional Brass Pressure Reducing Valve with Bypass	<b>230</b>
<b>QSSSA-LEGS</b>	Additional Stainless Steel Adjustable Legs (6"-7")	<b>262</b>

**NOTE:** 6" plastic adjustable legs (6"-7") standard.  
Description of accessories is shown on page 239. Only leg mounting is available.

**WATER TEMPERATURE RECOVERY TABLE**

Imperial Model	40°F Rise	70°F Rise	Imperial Model	40°F Rise	70°F Rise
<b>S-6</b>	60 gph	34 gph	<b>S-24</b>	241 gph	138 gph
<b>S-7</b>	70 gph	40 gph	<b>S-27</b>	271 gph	155 gph
<b>S-9</b>	90 gph	52 gph	<b>S-30</b>	301 gph	172 gph
<b>S-12</b>	120 gph	69 gph	<b>S-36</b>	361 gph	206 gph
<b>S-13</b>	135 gph	77 gph	<b>S-39</b>	391 gph	224 gph
<b>S-15</b>	151 gph	86 gph	<b>S-40</b>	407 gph	232 gph
<b>S-17</b>	173 gph	99 gph	<b>S-45</b>	452 gph	258 gph
<b>S-18</b>	181 gph	103 gph	<b>S-54</b>	542 gph	310 gph
			<b>S-57</b>	573 gph	326 gph

**NOTE:** gph is "gallons per hour."

## Booster Installation

### SINGLE BOOSTER INSTALLATION

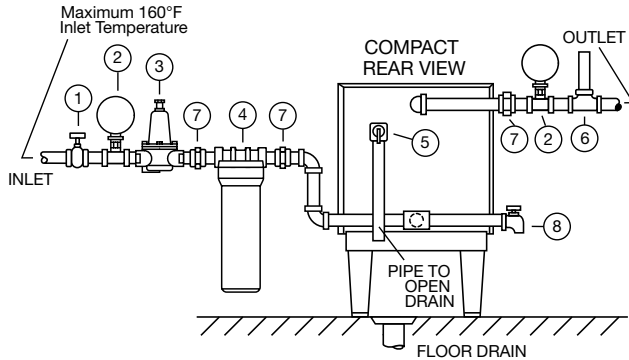

### DUAL BOOSTER INSTALLATION

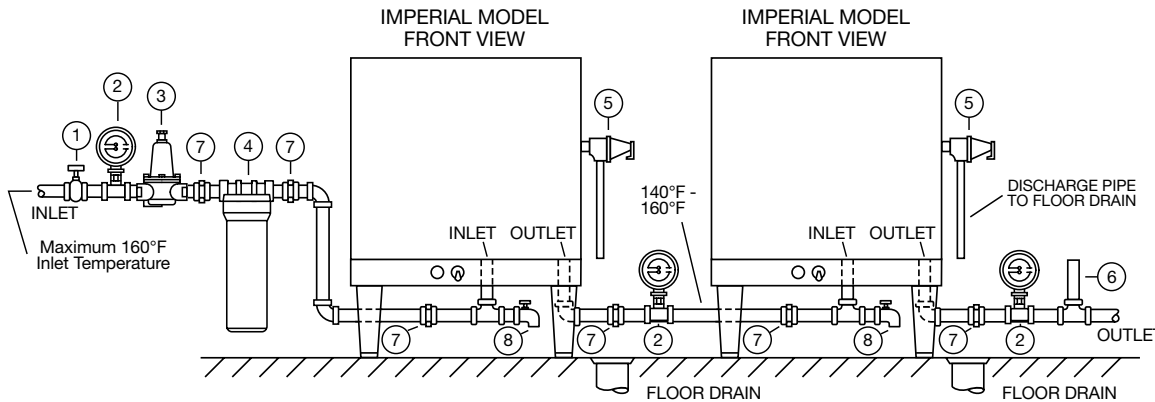

- ① 3/4" Gate or Ball Valve\*    ② Temperature/Pressure Gauge    ③ Pressure Reducing Valve with By-Pass    ④ Blended Phosphate Water Treatment System
- ⑤ Relief Valve (must have discharge pipe to floor drain)    ⑥ Shock Absorber    ⑦ Union\*    ⑧ Drain Pipe Valve\*    \*Supplied by installer

CONSULT LOCAL CODES

**NOTE:** The differential temperature between outlet and inlet temperatures should never be less than 20°F.

**NOTE:** Thermostat calibration, or adjustment, must be performed at time of installation and is excluded from warranty coverage. Thermostat adjustments for Low-Temp applications are the responsibility of the installer.

### BOOSTER WATER HEATER ACCESSORIES

#### Back Pressure Relief Valve –

This valve relieves pressure when unit is heating, on models that a check valve is required on the supply line. To be plumbed over an open site drain.



#### Bronze Pressure Reducing Valve –

This valve provides reduced corrosion and lead-free compliance. This adjusts water flow pressure to 20 psi.



**Stainless Steel Adjustable Legs –** Adjustable from 6" to 7". Clean appearance and heavy-duty for long wear.



#### Floor Mounting Hardware –

Adjustable from 6" to 7". Corrosion-resistant stainless steel legs for deck mounting.



#### Blended Phosphate Water Treatment System –

Standard and required with Powermite® units. Minimizes scale formation and increases unit efficiency. Recommended for Electric Boosters. (Not for potable water use.)

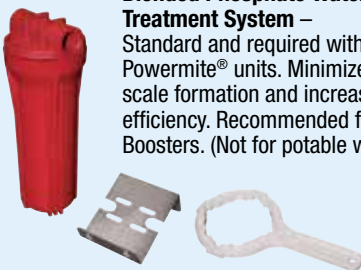

**Shock Absorber –** Recommended between the booster and the dishwasher to prevent water hammer. Standard with Powermite® gas boosters.

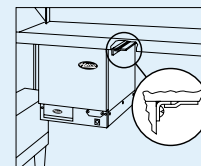

**Slide Bracket –** For mounting the booster heater under a dishwasher (available on small and large Compact models only).



## Water Heater Data

### PLUMBING DATA

Dielectric couplings should be used in connecting dissimilar metals, such as galvanized to copper, to prevent electrolysis.

All Hatco Booster Water Heaters require ¾" piping.

A check valve should not be installed in the supply line to the booster heater.

All shut-off valves must be gate or ball valves – not globe valves.

### BOOSTER HEATER SIZING FORMULA

$$\left( \frac{\text{GPH} \times \text{°F Temp. Rise}}{400} = \text{kW} \right)$$

NOTE: GPH is gallons per hour.

### SEE BOOSTER HEATER SIZING CHART, PAGES 241-243.

NOTE: When primary temperatures are less than 85°F consult factory for suitable booster heater.

### ELECTRICAL FORMULAS

$$\begin{aligned} \text{Watts} &= \text{Amps} \\ \text{Volts} & \quad 1\text{-phase} \end{aligned}$$

$$\begin{aligned} \text{Watts} \times .86 &= \text{Amps} \\ \text{Volts} & \quad 3\text{-phase} \\ & \quad (\text{open delta}) \end{aligned}$$

$$\begin{aligned} \text{Watts} &= \text{Amps} \\ \text{Volts} \times 1.73 & \quad 3\text{-phase} \\ & \quad (\text{balanced delta}) \end{aligned}$$

### WATER TEMPERATURE RECOVERY TABLE IN GPH °F RISE

kW	30°	40°	50°	60°	70°	80°	90°	100°
4	54	40	32	27	23	20	18	16
5	67	50	40	33	29	25	22	20
6	80	60	48	40	34	30	27	24
7	94	70	56	47	40	35	31	28
9	120	90	72	60	52	45	40	36
9.9	132	99	79	66	57	50	44	40
10.5	140	105	84	70	60	53	47	42
11.4	153	114	92	76	65	57	51	46
12	161	120	96	80	69	60	54	48
13.5	181	135	108	90	77	68	60	54
15	201	151	120	100	86	75	67	60
17.25	231	173	139	115	99	87	77	69
18	241	181	145	120	103	90	80	72
24	321	241	193	161	138	120	107	96
27	361	271	217	181	155	135	120	108
30	401	301	241	201	172	151	134	120
36	482	361	289	241	206	181	161	145
39	522	391	313	261	224	196	174	157
40.5	542	407	325	271	232	203	181	163
45	602	452	361	301	258	226	201	181
54	723	542	434	361	310	271	241	217
57	763	573	458	381	326	286	254	229

## Sizing Chart For Low-Temp Dishmachines

BOOSTERS RATED AT 30°F RISE

Dishwasher Model Number	Electric Compact Booster	Electric Imperial Booster	Dishwasher Model Number	Electric Compact Booster	Electric Imperial Booster
<b>AMERICAN DISH SERVICE</b>			<b>CHAMPION</b>		
AH, AH-3D, AH-3D-S, AHC, AHC-3D, AHC-3D-S, ET-A, T-AF, ET-AH, ET-A-M, ET-AH-M, ET-A-3, ET-AH-3, L-90-3D, L-90-3D-K, L-90-3D-K-S, L-90-3D-S, L-90-3DC, L-90-3DC-K, L-90-3DC-K-S, L-90-3DC-S, L-90-3DW, L-90-3DW-K, L-90-3DW-K-S, L-90-3DW-S, L-90-3DWC, L-90-3DWC-K, L-90-3DWC-K-S, L-90-3DWC-S, WH, WHC	C-4	S-6	ULD, ULF	C-6	S-6
A-3D, A-3D-S, A, AC, AC-3D, AC-3D-S, AH-B, ET-AF-3, ET-AF-M, HT-25, L-60-3D, L-60-3D-K, L-60-3D-K-S, L-60-3D-S, L-60-3DC, L-60-3DC-K, L-60-3DC-K-S, L-60-3DC-S, L-60-3DW, L-60-3DW-K, L-60-3DW-K-S, L-60-3DW-S, L-60-3DWC, L-60-3DWC-K, L-60-3DWC-K-S, L-60-3DWC-S, L-72-3D, L-72-3D-K, L-72-3D-K-S, L-72-3D-S, L-72-3DC, L-72-3DC-K, L-72-3DC-K-S, L-72-3DC-S, L-72-3DW, L-72-3DW-K, L-72-3DW-K-S, L-72-3DW-S, L-72-3DWC, L-72-3DWC-K, L-72-3DWC-K-S, L-72-3DWC-S, W, WC	C-5	S-6	DLF	C-13	S-13
A-B, AD-25, SS-25, 5-AH, 5-AHS	C-6	S-6	KL44, KL66	C-36	S-36
AF, AF-3D, AF-3D-S, AF-B, AFC, AFC-3D, AFC-3D-S, AFW, AFWC, 5, 5-S	C-7	S-7	<b>CMA DISHMACHINES</b>		
ADC-44, ADC-66, 5-AG, 5-AGS, 5-CD-LF, 5-CD-RF	C-9	S-9	A-1, AH-1, C-1, VAC-1, A-3, AH-3, C-3, L-1C, VAC-3, VAC-4, VAC-5, L-1X	C-4	S-6
<b>BLAKESLEE</b>			A-2, AH-1, AH-2, AH-3, B-3, C-1, C-2, C-3, EVA-1, EVA-2, EVA-3, EVA-4, EVA-5, VAC-2	C-6	S-6
U21-C	C-4	S-6	B-1	C-7	S-7
D-8-LT	C-6	S-6	B-2	C-9	S-9
DD-8-LT, R-CC64-LT, R-EE-LT	C-12	S-12	CMA-44L with tank heater, CMA-66L	C-24	S-24
Series XF-EE-LT, XF-PEE-LT, XF-LL-LT, XF-PLL-LT, XF-MM-LT, XF-PMM-LT, XF-EEE-LT, XF-LLL-LT, XF-MMM-LT	C-13	S-13	CVA-1, CVA-2, CVA-3, CVA-4	C-6	S-6
Series R-L-LT, R-PL-LT, R-M-LT, R-PM-LT, F-L-LT, F-PL-LT, F-M-LT, F-PM-LT (single tank)	C-36	S-36	CVA-5	C-7	S-7
Series "R" & "F" -CC-LT, -EE-LT, -LL-LT, -MM-LT, -LLL-LT, -MMM-LT, -PCC-LT, -PEE-LT, -PLL-LT, -PMM-LT (multi-tank)	C-24	S-24	<b>HOBART</b>		
Series XF-L-LT, XF-PL-LT, XF-M-LT, XF-PM-LT (single tank)	C-54	S-54	LX-18C, LX-30C, LX-40C, WM-5C, SR24C	C-4	S-6
Series XF-PEE-LT, XF-PLL-LT, XF-PMM-LT, XF-EEE-LT, XF-LLL-LT, XF-MMM-LT (multi-tank)	C-36	S-36	LT-1	C-6	S-6
FA (Flight-A-Round) and RA (Rack-A-Round) use comparable "F" listing.			AM-14, AM-14C	C-7	S-7
			C44A, CRS66A, CPW80A	C-27	S-27
			FT-800	C-30	S-30
			<b>JACKSON</b>		
			Conservar 24LT, 200LT, ES1000 (Ecolab/Jackson)	C-4	S-6
			Conservar 1, Conservar XL, ES2000 (Ecolab/Jackson)	C-9	S-9
			Conservar 2, Conservar XL2, ES4000 (Ecolab/Jackson)	C-15	S-15
			AJ-44, AJ-66, AJ-80	C-18	S-18
			<b>KNIGHT EQUIPMENT LTD.</b>		
			KLE-112-HL	C-5	S-6
			KLE-117i, KLE-117c, KLE-175GT, KLE-175GTM	C-9	S-9
			KLE-235d	C-13	S-13
			KLE-175GT Corner, KLE-175GTM Corner	C-12	S-12

## Low-Temp Sizing Data

Chemical low-temp dishwashers are most effective when supplied with a 140°F hot water supply. Sometimes this water temperature is not available due to undersized primary water heaters or local safety codes. Hatco can provide a pre-heater for chemical low-temp dishwashers to provide an adequate supply of 140°F hot water for proper operation.

NOTE: When ordering a heater for use with a chemical low-temp dishwasher, thermostat adjustments for low-temp applications are the responsibility of the installer.

### To properly size a Hatco heater for low-temp use:

- Determine the required temperature rise by subtracting the available hot water supply temperature from 140°F. This should be a minimum of 30°F.
- Determine the water usage by consulting the dishwasher data plate, literature, or NSF listing. This should be shown as gallons per hour (GPH).
- Use the Hatco formula for sizing or the sizing chart on this page to determine the required kW and select the appropriate Hatco model.





## Booster Heater Sizing Chart

Dishwasher Model Number	Electric Compact Booster Temperature Rise		Electric Imperial Booster Temperature Rise		Gas Powermite® Booster <sup>□</sup> Temperature Rise <sup>□</sup>	
	40°F	70°F	40°F	70°F	40°F	70°F
<b>ADAMATION</b>						
GSL-1390, CA-2, CA-3, CA-4, SLAP 44	C-39	(2)C-36	S-39	(2)S-36	PMG-200	(2)PMG-200
CA, CA-1	C-54	(2)C-45	S-54	(2)S-45	PMG-200	(2)PMG-200
<b>ALVEY</b>						
FLC-10, SL-2S			S-6	S-9		
FLC-12, CL-1, CL-1 Turntable, SA-5A			S-7	S-12		
FL-2S			S-9	S-13		
KS-70, KS70M SB			S-9	S-15		
SL-2D			S-13	S-18		
FLC-36			S-15	S-27		
KS-88-C			S-18	S-30		
KS-70-N, KS-88-N			S-39	(2)S-40		
<b>AMERICAN DISH SERVICE</b>						
AF-ES, AFC-ES	C-4	C-7	S-4	S-7		
HT-25	C-7	C-12	S-7	S-12		
ADC-44, ADC-66	C-12	C-24	S-12	S-24		PMG-100
<b>BLAKESLEE</b>						
UC-21A, UC-21B	C-4	C-4	S-6	S-6	PMG-100	PMG-100
UC-21	C-6	C-12	S-6	S-12	PMG-100	PMG-100
D-8	C-9	C-13	S-9	S-13	PMG-100	PMG-100
D-9	C-12	C-17	S-12	S-17	PMG-100	PMG-100
Series "R" & "F" - CC, -EE, -LL, -MM, -LLL, -MMM, -PCC, -PEE, -PLL, -PMM (multi-tank) with suffix "LC"	C-13	C-24	S-13	S-24	PMG-200	PMG-200/100
Series XF-EE, XF-LL	C-17	C-30	S-17	S-30	PMG-100	PMG-200
Series XF-LL, XF-PLL, XF-MM, XF-PMM, XF-EEE, XF-LLL, XF-MMM (Multi-tank) with suffix "LC"	C-17	C-30	S-17	S-30	PMG-200	PMG-200/100
DD-8	C-18	C-30	S-18	S-30	PMG-100	PMG-200
Series F-E, FA-EE, FA-PEE, FA-LL, FA-PLL, FA-MM, FA-PMM, F-EEE, FA-EEE, FA-LLL, FA-MMM, F-PE	C-30	C-54	S-30	S-54	PMG-200	PMG-200/100
Series R-L, R-PL, R-M, R-PM, F-L, F-PL, F-M, F-PM (single tank)	C-36	C-54	S-36	S-54	PMG-200	(2)PMG-200
Series XF-L, XF-PL, XF-M, XF-PM (single tank)	(2)C-36		(2)S-36			
Series R-E, R-PE, XF-PEE, XF-PLL, XF-PMM, XF-EEE, XF-LLL, XF-MMM (multi-tank) FA (Flight-A-Round) and RA (Rack-A-Round) use comparable "F" listing.	C-45	(2)C-30	S-45	(2)S-30	PMG-200	(2)PMG-200
XF-EE, XF-EE-LT (with LT suffix)	C-17	C-36	S-17	S-36	PMG-100	PMG-200
<b>CHAMPION</b>						
U-H1, UH-200, UH-200B, U-HB	C-4	C-6	S-6	S-6	PMG-100	PMG-100
UL-100, UH-100B, UH-170B, UH-200B, DH-2000	C-6	C-9	S-6	S-9	PMG-100	PMG-100
UL-150	C-4	C-7	S-6	S-7	PMG-100	PMG-100
UH-150, UH-150B, UH-100, UH-100B, DHB-VS	C-5	C-9	S-6	S-9	PMG-100	PMG-100
D-H1, D-HB, D-H1T, D-HBT	C-9	C-13	S-9	S-13	PMG-100	PMG-100
44 DRWS, 66 DRPWWS, 80 DRHDPWWS, 70 DRFFPWWS	C-9	C-13	S-9	S-13	PMG-100	PMG-100
PP-28	C-27	C-45	S-27	S-45	PMG-100	PMG-200
D-H1C, D-H1TC	C-9	C-18	S-9	S-18	PMG-100	PMG-100
DL-1000, DH-1000, DHB-VS	C-6	C-12	S-6	S-12	PMG-100	PMG-100
44DR, 66DRPW, 80DRHDFW, 70DRFFPW, 54DR, 76DRPW, 80DRFFPW, 90DRHDPW	C-12	C-24	S-12	S-24	PMG-100	PMG-100
44-WS, 66 WSPW, 66-WS, 64, 70WSFFPW, 80WSHDPW, 90FFPW, 100HDPW, 86 PW, 84, 106 PW, 120 HDPW, 110 FFPW	C-15	C-24	S-15	S-24	PMG-100	PMG-100
UC-CW6-WS	C-24	C-36	S-24	S-36	PMG-100	PMG-200
US-CW8-WS	C-24	C-39	S-24	S-39	PMG-100	PMG-200
44, 66 PW, 70FFPW, 80HDPW	C-27	C-54	S-27	S-54	PMG-100	PMG-200
54, 76PW, 80FFPW, 90HDPW,	C-24	C-45	S-24	S-45	PMG-100	PMG-200
40-KB, 40-KB-2-2, 40-KFWB, 40-KPRB, 40-KPRB-2-2, 40KPRB-2-3, 44LT, 60-KB, 60-KB-2-2, 60-KFWB, 60-KFWB-2-2, 60-KPRB, 60-KPRB-2-3, 64KB, 64-KB Corner, 64-KPRB, 64-KPRB Corner, 64 Modular, 66LT, 86 Modular	C-30	C-54	S-30	S-54	PMG-200	PMG-200/100
44-KB, 44-KB Corner, 44-KPRB, 44-KPRB Corner, 54-KB, 54-KB Corner, 54-KPRB, 54-KPRB Corner, 44 Modular, 66 PW Modular, UC** Series 6' Center, UC-C4	C-36	C-57	S-36	S-57	PMG-200	PMG-200/100
UC-CW4	C-36	(2)C-36	S-36	(2)S-36	PMG-200	PMG-200/100
UC-C	C-45	(2)C-36	S-45	(2)S-36	PMG-200	PMG-200/100
UC**CW Series 6' Center	C-45	(2)C-39	S-45	(2)S-39	PMG-200	(2)PMG-200
W-6-WS, W6	C-45	(2)C-45	S-45	(2)S-40	PMG-200	(2)PMG-200

□ Powermite installations above 2,000 ft. will reduce the above capacities and may require change of pressure and/or orifices in certain models at time of install to meet IAS safety compliance. These modifications are the responsibility of the installer. Consult "Installation and Operating Manual" for sizing adjustments and orifice changes.



## Booster Heater Sizing Chart

Dishwasher Model Number	Electric Compact Booster Temperature Rise		Electric Imperial Booster Temperature Rise		Gas Powermite® Booster Temperature Rise†	
	40°F	70°F	40°F	70°F	40°F	70°F
<b>CMA DISHMACHINES</b>						
AH, C, B <sup>o</sup>	C-9					
CMA-180	C-5	C-9	S-5	S-9		
CMA-180T	C-9	C-13	S-9	S-13		
CMA-44/66	C-24	C-36	S-24	S-36	PMG-100	PMG-200
CMA-44H with tank heater, CMA-66H	C-36	C-45	S-36	S-45	PMG-100	PMG-200
EAH/EC <sup>o</sup> , GLX/L1X/L1X16/L1C	C-4					
EST <sup>o</sup>	C-5					
EST-44/66	C-12	C-24	S-12	S-24	PMG-100	PMG-100
<b>HOBART</b>						
AM-15F	C-4	C-6	S-6	S-9	PMG-100	PMG-100
LXiC, LXiGC, LX-18C, LX-30C, LX-40C, AM-15F	C-4	C-7	S-6	S-6	PMG-100	PMG-100
LX-30, SR24, SR24H	C-4	C-7	S-6	S-7	PMG-100	PMG-100
LX-18, AM-14F, AM-15, AM-15T	C-5	C-9	S-6	S-9	PMG-100	PMG-100
WM-5C	C-6	C-9	S-6	S-9	PMG-100	
WM-5 (Without sump heater)	C-7	C-12	S-7	S-12		
AM-14T, AM-14TC	C-7	C-12	S-7	S-12	PMG-100	PMG-100
AM-14, AM-14C	C-9	C-17	S-9	S-17	PMG-100	PMG-100
AM-12, AM-12C*	C-9	C-12	S-9	S-12	PMG-100	PMG-100
UW-50			S-15	S-24		
<sup>OR</sup> Opti-RinSe C44A, CRS-66A, CCS-66A, CPW-80A, C54A, CRS-76A, CCS-76A, CPW-90A, C64A, CRS-86A, CCS-86A, CPW-100A, C88A, CRS-110A, CCS-11-0A, CPW-124A	C-15	C-27	S-15	S-27	PMG-100	PMG-200
C-54A, CRS-76A, CPW-90A, CCS-76A	C-39	(2)C-36	S-39	(2)S-36	PMG-200	PMG-200/100
C-44A, CRS-66A, CCS-66A, CPW-80A, C-64A, CRS-86A, CCS-86A, CPW-100A	C-30	C-54	S-30	S-54	PMG-200	PMG-200/100
C-88A, CRS-110A, CPW-124A, CCS-110A	C-36	C-54	S-36	S-54	PMG-200	PMG-200/100
Opti-RinSe C44AW, CRS-66AW, CCS-66AW, CPW-80AW	C-9	C-15	S-9	S-15	PMG-100	PMG-100
<sup>OR</sup> C-44AW, CRS-66AW, CPW-80AW, CCS-66AW	C-12	C-24	S-12	S-24	PMG-100	PMG-100
C-44, CRS-66, CPW-80	C-36	C-54	S-36	S-54	PMG-200	PMG-200/100
CL44e, CL66e	C-13	C-24	S-13	S-24	PMG-100	PMG-200
CLPS66e	C-15	C-30	S-15	S-30	PMG-100	PMG-200
C-54, CRS-76, CPW-90	C-54	(2)C-39	S-54	(2)S-39	PMG-200/100	(2)PMG-200
C-64W, CRS-86W, CPW-100W, C-88W, CRS-110W, CPW-124W, CCS-86W	C-24	C-36	S-24	S-36	PMG-100	PMG-200
C-64, CRS-86, CPW-100	C-45	(2)C-36	S-45	(2)S-36	PMG-200	PMG-200/100
FT800W, FT-900W	C-24	C-39	S-24	S-39	PMG-200	PMG-200
FT-600, FT-700	C-54	(2)C-39	S-54	(2)S-39	PMG-200/100	(2)PMG-200
FT800	C-39	(2)C-39	S-39	(2)S-39	PMG-200	(2)PMG-200
FT900	C-36	C-57	S-36	S-57	PMG-200	PMG-200/100
FT800S, FT-900S	C-39	(2)C-36	S-39	(2)S-36	PMG-200	PMG-200/100
UTW-28, UTW-28C			S-18	S-36		
FRC and FR (Fast Rack Series) use comparable "C" line listing.						
<b>INSINGER</b>						
GS 302, GS-14	C-4	C-4	S-6	S-6	PMG-100	PMG-100
45SA-5	C-9	C-18	S-9	S-18	PMG-100	PMG-100
Commander 18-5 Series, CS-5, CS-5C, CS-5CH, CS-5H, Ensign 40-2	C-6	C-12	S-6	S-12	PMG-100	PMG-100
Commander 18-6 Series, 18-6H	C-6	C-12	S-6	S-12	PMG-100	PMG-100
Commander 18-6, 18-6H (Built-In)	ABB-13.5	ABB-13.5				
Admiral 44-4, 66-4, Speeder 64, 86-3, Clipper (all)	C-15	C-27	S-15	S-27	PMG-100	PMG-200
Admiral 44-4, 66-4 (Built-In)	ABB-15-8	ABB-27-8				
135-20, 185-20, 250-20, 60-20, 85-20, Gallymaster & Modular Century (all)	C-54			S-54		
Trac 878	C-24	C-45	S-24	S-45	PMG-100	PMG-200
Super 106-2, Trac 321, Trac 321-2/RPW	C-27	C-45	S-27	S-45	PMG-100	PMG-200
Defender Flight Machine	C-36	C-54	S-36	S-54	PMG-200	(2)PMG-200
Master RC 3-tank Flight Machine	C-15	C-27	S-15	S-27	PMG-200	(2)PMG-200
Master RC 4-tank Flight Machine	C-36	C-57	S-36	S-57		
CA-3♦			S-9	S-24	PMG-200	
DA-3♦			(2)S-9	(2)S-24		
For outdated models, consult factory for correct booster.						

\* Model AM-12 with serial no. 12-067-357 or below and model AM-12C with serial no. 12-067-537 or below require slightly larger booster than listed.

<sup>o</sup> All cycles.

<sup>OR</sup> C Models with serial no. 85-1041605 or greater use Opti-RinSe.

■ Shaded area indicates older models prior to Opti-RinSe.

□ Powermite installations above 2,000 ft. will reduce the above capacities and may require change of pressure and/or orifices in certain models at time of install to meet IAS safety compliance. These modifications are the responsibility of the installer. Consult "Installation and Operating Manual" for sizing adjustments and orifice changes.

♦ Consult factory – special plumbing may apply.



## Booster Heater Sizing Chart

Dishwasher Model Number	Electric Compact Booster Temperature Rise		Electric Imperial Booster Temperature Rise		Gas Powermite® Booster <sup>□</sup> Temperature Rise <sup>□</sup>	
	40°F	70°F	40°F	70°F	40°F	70°F
<b>JACKSON</b>						
JP-24, JP-24B, JP-24F, JP-24BF	C-4	C-6	S-6	S-6	PMG-100	PMG-100
24B Series		C-4		S-6		PMG-100
10AB, 10APRB		C-5		S-6		PMG-100
44CE*, 66 CERPW	C-30	C-54	S-30	S-54	PMG-200	
54CE, 76 CERPW	C-36	(2)C-30	S-36	(2)S-30	PMG-200	
64CE, 86 CERPW	C-27	C-39	S-27	S-39	PMG-200	
100	C-12	C-24	S-12	S-24	PMG-100	
100B, 100PRB, 150B, 150PRB		C-9		S-9		
150	C-12	C-18	S-12	S-18		PMG-100
200	C-7	C-12	S-7	S-12	PMG-100	PMG-100
200B		C-6		S-6		PMG-100
Tempstar GPX						PMG-100
Tempstar, Tempstar SDS, Tempstar HH	C-6	C-12	S-6	S-12	PMG-100	PMG-100
TS-44, TS-66	C-24	C-36	S-24	S-36	PMG-100	PMG-200
AJ-44, AJ-66, AJ-80, WH-44, ES-4400, ES-6600 (ECOLAB/JACKSON)	C-24	C-45	S-24	S-45	PMG-100	PMG-200
AJ-54, AJ-76, AJ-90	C-30	C-54	S-30	S-54	PMG-200	PMG-200/100
AJ-64, AJ-86, AJ-100	C-24	C-39	S-24	S-39	PMG-100	PMG-200
* Model #44CE w/SN1999 or below requires larger booster than listed.						
<b>KNIGHT EQUIPMENT LTD.</b>						
KLE-112-HL	C-7	C-12	S-7	S-12	PMG-100	PMG-100
<b>MEIKO</b>						
K-44, K-66, K-80	C-24	C-36	S-24	S-36	PMG-100	PMG-200
K-54, K-76, K-90, K-64, K-86, K-100	C-24	C-45	S-24	S-45	PMG-100	PMG-200
<b>METALWASH/INTEDGE</b>						
FW4	C-12	C-18	S-12	S-18	PMG-100	PMG-100
RS-30A, RS-28L			S-15	S-24		
RT-74, RT-60, RT-42B, RT-42BC			S-27	S-40		
RS-2R			S-30	S-45		
<b>STERO</b>						
ER-44, ER-44-10, ER-66S, ER-76S, ER-76SC	C-15	C-24	S-15	S-24	PMG-100	PMG-100
ER-64, ER-86S, ER-94S, ER-94SC	C-15	C-24	S-15	S-24	PMG-100	PMG-100
SCT-44-10-LW, SCT-44-LW, SCT-66S-LW, SCT-76S-LW, SCT-76SC-LW, SCT-90S-LW	C-15	C-24	S-15	S-24	PMG-100	PMG-100
SC-1-2-4-LW, SC-1-6-4-LW, SC-2-4-LW, SC-5-2-4-LW, SC-5-6-4-LW, SC-6-4-LW	C-15	C-24	S-15	S-24	PMG-100	PMG-200
SCT-64, SCT-86S, SCT-94S, SCT-94SC	C-24	C-45	S-24	S-45	PMG-100	PMG-200
SCT-108S, SCT-108SC, SCT-76, SCT-94SM	C-30	C-54	S-30	S-54	PMG-200	PMG-200/100
SC-6-4, SCT-44, SCT-44-10, SCT-66S, SCT-76S, SCT-76SC, SCT-90S	C-36	C-54	S-36	S-54	PMG-200	PMG-200/100
SCT-120S, SCT-120SC, SCT-120SM, SCT-150SM	C-36	C-57	S-36	S-57	PMG-200	PMG-200/100
STW-110, SC-1-2-7-4, SC-1-6-3-4, SC-1-6-7-4, SC-2-7-4, SC-5-2-7-4, SC-5-6-3-4, SC-5-6-7-4, SC-6-3-4, SC-6-7-4	C-30	C-54	S-30	S-54	PMG-200	PMG-200/100
SC-1-2-4, SC-1-6-4, SC-2-4, SC-5-2-4, SC-5-6-4	C-36	(2)C-57	S-36	(2)S-57	PMG-200	(2)PMG-200
SCT-44-10-SC-1-3-4, SCT-44-10-3-4, SCT-44-SC-1-3-4, SCT-44-SC-3-4, SCT-54-SC-1-3-4, SCT-54-SC-3-4, SCT-76S-SC-3-4	C-36	C-54	S-36	S-54	PMG-200	(2)PMG-200
STPC (Four tank)	C-24	C-45	S-24	S-45	PMG-100	PMG-200
STPCW (Four tank)	C-27	C-45	S-27	S-45	PMG-100	PMG-200
STPC	C-30	C-54	S-27	S-54	PMG-200	PMG-200/100
STPCW	C-36	(2)C-30	S-36	(2)S-30	PMG-200	PMG-200/100
SD-2RA, SDRA, SDRA-PACK	C-12	C-18	S-12	S-18	PMG-100	PMG-100
U-31-A, U-31-AC			S-24	S-45	PMG-100	PMG-200
U-31-A2			(2)S-24	(2)S-45	PMG-200	(2)PMG-200
STBUW-1	C-45	(2)C-36	S-45	(2)S-36		
SC-2-3-4, SC-5-2-3-4	C-30	C-45	S-30	S-45	PMG-200	
SC20-1 (low temp.)	C-12		S-12		PMG-100	
SC20-2 (low temp.)	C-12	C-24	S-12	S-24		PMG-100
SC-2-8, SC-2-9, SC-1-2-8, SC-5-6-8, SC-6-8, SC-6-9, SC-1-6-8, SC-5-6-9, SC-5-2-9, SC-1-6-9, SC-5-2-8 (low temp.)	C-18	C-36	S-18	S-36	PMG-100	PMG-200

□ Powermite installations above 2,000 ft. will reduce the above capacities and may require change of pressure and/or orifices in certain models at time of install to meet IAS safety compliance. These modifications are the responsibility of the installer. Consult "Installation and Operating Manual" for sizing adjustments and orifice changes.

This selector chart is based on 40°F and 70°F temperature rises, 20 psi flow pressure, and minimum rinse cycle timer setting in NSF listing.

All booster heaters are rated at 100% of the capacity of the dishwashers as recommended by the National Sanitation Foundation. Where make-up water for wash tank is provided from final rinse supply, chart recommendations are based upon this additional demand (not over 2 GPM) as required by NSF.

All sizings shown are that of the dishwasher manufacturers. Hatco Corporation is not responsible for incorrect sizing applications.

### BOOSTER HEATER SIZING FORMULA

$$\left( \frac{\text{GPH} \times \text{°F Temp. Rise}}{400} = \text{KW} \right)$$

NOTE: GPH is gallons per hour.



## Electrical Ratings For Hatco Water Heaters

Watts	Volts	Phase	Amps	Breaker or Fuse size	Watts	Volts	Phase	Amps	Breaker or Fuse size
<b>4kW</b>	208	1	19	30	<b>24kW</b>	208	1	115.4	150
	240	1	17	30		208	3	66.7	90
	480	1	8	15		240	1	100	125
<b>5kW</b>	208	1	24	30	240	3	57.8	90	
	240	1	21	30	480	3	29.9	40	
	480	1	10	15	600	3	23.2	30	
<b>6kW</b>	208	1	29	40	<b>27kW</b>	208	1	129.8	175
	208	3	25 $\Delta$	40		208	3	75	100
	240	1	25	40		240	1	112.5	150
	240	3	22 $\Delta$	30		240	3	65	90
	480	3	11 $\Delta$	15		480	3	32.5	50
<b>7kW</b>	600	3	5.7	15	600	3	26.1	40	
	208	1	34	50	<b>30kW</b>	208	1	144	200
	208	3	29 $\Delta$	40		208	3	83.3	125
	240	1	29	40		240	1	125	175
	240	3	25 $\Delta$	40		240	3	72.3	100
480	3	13 $\Delta$	20	480		3	36	50	
<b>9kW</b>	600	3	6.7	15	600	3	29	40	
	208	1	43	60	<b>36kW</b>	208	1	173	225
	208	3	38 $\Delta$	50		208	3	100	125
	240	1	38	50		240	1	150	200
	240	3	33 $\Delta$	50		240	3	86.7	125
480	3	16.3 $\Delta$	30	480		3	43.3	60	
<b>9.9kW</b>	600	3	8.7	15	600	3	34.8	50	
	208	1	47.5	60	<b>39kW</b>	208	1	187.5	250
	208	3 (BAL.)	27.5	40		208	3	108	150
208	3 (BAL.)	28.8	40	240		1	163.5	225	
<b>10.4kW</b>	208	3 (BAL.)	28.8	40	240	3	94	125	
<b>11.4kW</b>	240	1	47.5	60	480	3	47	60	
	240	3 (BAL.)	27.5	40	600	3	37.7	50	
	480	3 (BAL.)	13.7	20	<b>40.5kW</b>	208	3	112.5	150
<b>12kW</b>	208	1	58	90		240	3	97.5	125
	208	3	33	50		480	3	48.8	70
	240	1	50	70		600	3	39	50
	240	3	29	40		<b>45kW</b>	208	3	125
	480	3	14.5	20	240		1	188	250
600	3	11.6	20	240	3		108	150	
<b>13.5kW</b>	208	1	65	90	480	3	54	70	
	208	3	38	50	600	3	43.5	60	
	240	1	56.3	90	<b>54kW</b>	208	3	150	200
	240	3	33	50		240	3	130	175
	480	3	16.3	30		480	3	65	90
<b>15kW</b>	600	3	13	20	600	3	52.1	70	
	208	1	72	90	<b>57kW</b>	208	3	158.4	200
	208	3	41.7	60		240	3	137.3	175
	240	1	62.5	90		480	3	68.6	90
	240	3	36.1	50		600	3	54.9	70
480	3	18.1	30						
600	3	14.5	20						
<b>17.25kW</b>	208	3	47.9	60					
<b>18kW</b>	208	1	86.5	125					
	240	1	75	100					
	240	3	43.4	60					
	480	3	21.7	30					
	600	3	17	30					

$\Delta$  Open Delta (unbalanced load) amperage of high leg indicated.

**USE COPPER WIRE ONLY**

**ELECTRICAL FORMULAS**

Watts = Amps  
Volts 1-phase

$\frac{\text{Watts} \times .86}{\text{Volts}} = \text{Amps}$   
3-phase  
(open delta)

$\frac{\text{Watts}}{\text{Volts} \times 1.73} = \text{Amps}$   
3-phase  
(balanced delta)



## Food Pans And Trivets



**PIZZA PANS**  
14"PIZZA PAN  
16"PIZZA PAN  
18"PIZZA PAN



**ST PANS**  
ST PAN 1/3  
ST PAN 1/2  
ST PAN 2  
ST PAN 4

### FOOD PANS

Model	Description	List Price
<b>ALUM PAN</b>	Half-Size Sheet Pan – 18"W x 13"D	\$ 37
<b>18"SHEET PAN</b>	Full-Size Sheet Pan – 18"W x 26"D	52
<b>14"PIZZA PAN</b>	Perforated Pizza Pan – 14" Diameter	40
<b>16"PIZZA PAN</b>	Perforated Pizza Pan – 16" Diameter	46
<b>18"PIZZA PAN</b>	Perforated Pizza Pan – 18" Diameter	48
<b>ST PAN 1/3</b>	Third-Size Stainless Steel Pan – 12¾"W x 6⅞"D x 2½"H	68
<b>ST PAN 1/2</b>	Half-Size Stainless Steel Pan – 12¾"W x 10⅞"D x 2½"H	78
<b>ST PAN 2</b>	Full-Size Stainless Steel Pan – 12¾"W x 20¾"D x 2½"H	93
<b>ST PAN 4</b>	Full-Size Stainless Steel Pan – 12¾"W x 20¾"D x 4"H	117



**HDW TRIVET**



**HDW-SPLASH**



**HDW 6" PAN**

### FOOD PANS AND TRIVETS

Model	Description	List Price
<b>HDW-TRIVET</b>	Custom Trivet raises food product ½" off bottom of Full-Size Pan - 17½" x 9½" x ½"	\$ 70
<b>HDW-SPILL</b>	Water/Spillage Pan – one per drawer (excludes HDW-1R2, -2R2)	308
<b>HDW-SPLASH</b>	Splash Baffle – one per drawer (excludes HDW-1R2)	65
<b>HDW 6" PAN</b>	Full-Size Stainless Steel Food Pan 12¾"W x 20¾"D x 6"H	127

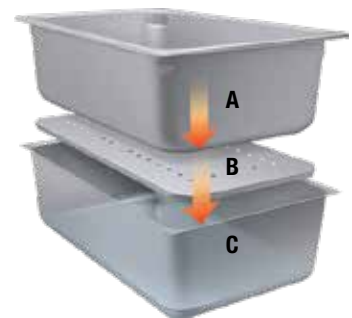

**Additional Humidity**

- A. Stainless Steel Food Pan
- B. Splash Baffle  
**HDW-SPLASH** Accessory
- C. Water/Spillage Pan (adds ¼" of water)  
**HDW-SPILL** Accessory

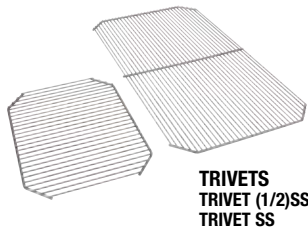

**TRIVETS**  
TRIVET (1/2)SS  
TRIVET SS

### FOOD PANS AND TRIVETS

Model	Description	List Price
<b>Wire Trivets Stainless –</b>		
<b>TRIVET (1/2)SS</b>	Half-Size – 10⅞"W x 7⅞"D	\$126
<b>TRIVET SS</b>	Full-Size – 10⅞"W x 18"D	175

# Check out our *Quick-Ship* Program

When you need equipment shipped sooner than our normal lead time, our "Quick-Ship" program offers our most popular equipment in various voltages ready for immediate shipment based on availability.

Check with your Hatco representative to see if the equipment you need is available through our Quick-Ship program. If it is, your order will be shipped the same day (orders placed before noon Central Standard Time), or the next day if ordered after noon.\*

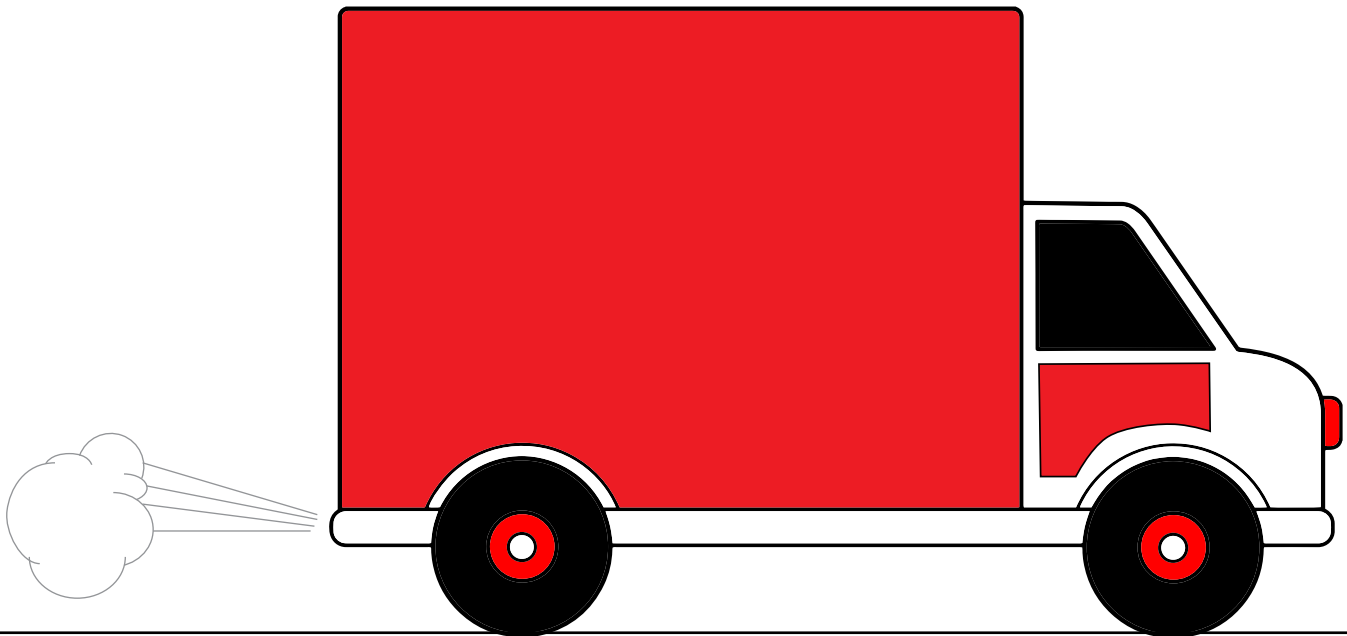

\*All orders are subject to credit approval.

## General Information

**Terms of Sale:** EX Works

Sturgeon Bay, WI 54235 U.S.A.

**Corporate Office:** Milwaukee, Wisconsin 53215

**Manufacturing:** Sturgeon Bay, Wisconsin 54235

**Price Policy:** Prices supercede all previously published prices and are subject to change without notice. Prices and discounts apply to accessories at time of initial equipment order only.

**Remittance: Forward payment to:**

Hatco Corporation  
Box 68-4035  
Chicago, IL 60695-4035

**Delivery:** Consult Hatco Equipment Sales Department for delivery times and estimated shipping charges.

**Freight Classification:** See Hatco website for more details:  
www.hatcocorp.com  
under the RESOURCES tab in the upper right-hand corner, click on EQUIPMENT SHIPPING INFO

**Business Hours:**

**Equipment Sales & Customer Service**  
7:00 a.m. to 5:00 p.m. Central Time

**General Office**  
8:00 a.m. to 5:00 p.m. Central Time

(Summer Hours: June to September:  
8:00 a.m. to 5:00 p.m. C.T. Monday through Thursday  
8:00 a.m. to 2:30 p.m. C.T. Friday)

Sales catalogs, brochures, specification sheets and other literature available at www.hatcocorp.com.

ALL HATCO PRODUCTS SHIPPED WITH INSTALLATION AND OPERATING INSTRUCTIONS. CONSULT LOCAL CODES BEFORE INSTALLING EQUIPMENT.

**E-mail inquiries and requests to:** support@hatcocorp.com

**E-mail orders to:** equipsales@hatcocorp.com

**Telephone:** Equipment Orders & Inquiries: (414) 671-6350  
General Office: (414) 671-6350

**www.hatcocorp.com**

## Conversions

Watts ÷ Volts = Amps (Single Phase only)

Inches x 25.4 = Millimeters

Pounds ÷ 2.2 = Kilograms or Pounds x .4536 = Kilograms

(°Fahrenheit - 32) x .56 = °Celsius

Gallons ÷ .264 = Liters or Gallons x 3.7853 = Liters

## Water Quality Requirements

Water supply in excess of 3.0 grains of hardness per gallon (GPG) must be treated and softened before being used. Water containing over 3.0 GPG will decrease the efficiency and reduce the operating life of the unit.

**NOTE:** Product failure caused by liming or sediment buildup is not covered under warranty.

**NOTE:** See page 239 for Picture of Blended Phosphate Water Treatment System.

Hatco products are manufactured for commercial use only and meet one or more of these agency certifications.



See product specification sheet for the appropriate approvals.

### 120 Volt Models

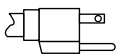

NEMA 5-15P



NEMA 5-20P

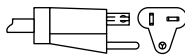

NEMA 5-30P

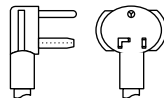

### 208 or 240 Volt Models

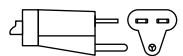

NEMA 6-15P



NEMA 6-20P

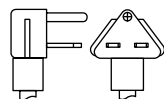

NEMA 6-30P

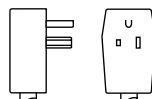

NEMA 6-50P

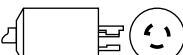

NEMA L6-20P

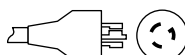

NEMA L6-30P



NEMA L14-20P



NEMA L15-30P

## Limited Warranty

For the full information pertaining to the Hatco warranty protection for your equipment, go to our website at:

[www.hatcocorp.com](http://www.hatcocorp.com)

Step 1: Make sure you have the correct region selected

Step 2: in the **Support** drop-down at the top of the page, select **Warranty**

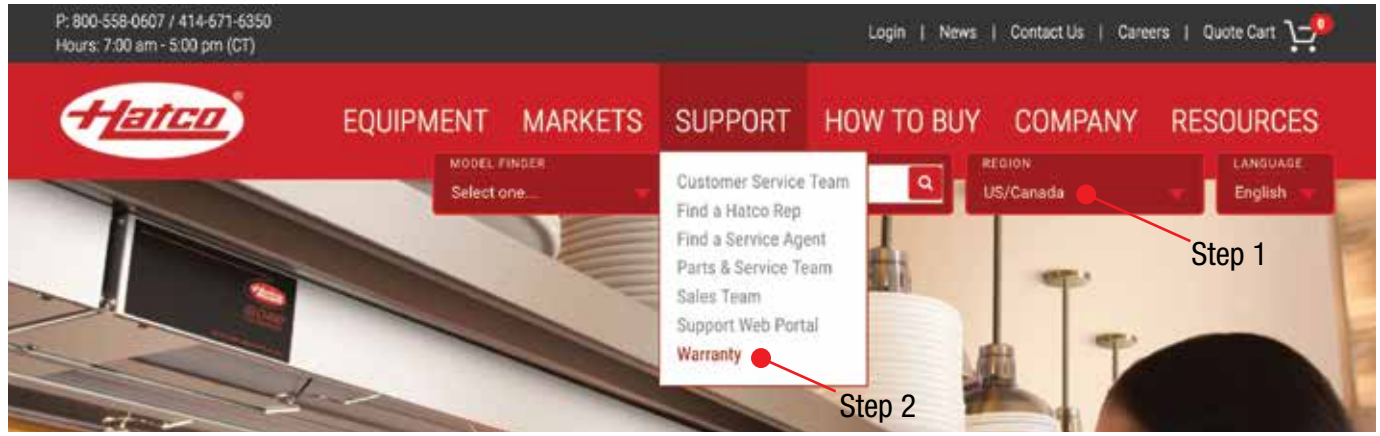

## Ordering Procedures

### CUSTOMER NOTE –

To ensure prompt and accurate processing of your order, please provide the following information:

### ALL PRODUCTS –

1. Model number, voltage and phase.
2. Specify options and accessories as required. Options are not retrofittable.
3. Consult factory when ordering equipment for special applications.
4. Phone orders are acceptable, but a confirming written order is required. E-mail orders do not require confirmation.

## Returns

New and unused equipment can only be returned for credit review with prior approval of the Hatco Corporation. Contact Customer Service or Sales & Marketing for a Material Return Authorization (MRA). Returns must be shipped PREPAID and are subject to inspection. All goods returned for customer convenience are subject to a restocking charge of 25%. In the event of an error by Hatco, an MRA will be issued for full credit. Custom-built equipment and equipment older than 120 days (from date of shipment) do NOT qualify for return credit. Products with electronic controls, Flav-R 2-Go® Locker Systems (all models), Pickup Pod™ (all models), Decorative Lamps (all models), and Flav-R-Shield® Sneeze Guards (all models) are custom by nature and are non-returnable.

**Return Equipment to:** Hatco Corporation  
208 East Deck Street  
Sturgeon Bay, WI 54235-3930 U.S.A.

## Damaged Freight Policy

In accordance with the National Motor Freight Traffic Association, it is the consignee's responsibility to inspect and ensure the shipment has not sustained any damage during transportation to destination. All freight should be inspected during the receiving process for possible damage. Should there be a question about the condition of the equipment, it is better to refuse the shipment. If damage is found after delivery, it is the consignee's (receiver) responsibility to notify Hatco Corporation (notify the carrier if shipped third party) **five (5) calendar days** of the delivery.

Whether the shipment was routed by a Hatco preferred carrier or customer selected third party carrier, Hatco will assist its customers in achieving a solution. If it is found that any part of the shipment has sustained damage during transportation, Hatco Corporation must be contacted to file a damage report.

For assistance, contact Hatco Customer Service at (414)671-6350 and have the information listed below available.

1. Copy of Bill of Lading and Pro numbers
2. Delivery date and date damage was discovered
3. Contact name, phone number and email address
4. Type of unit damaged including model and serial number
5. Extent of damage
6. Pictures of damage as well as packaging
7. Original shipping papers and packaging

## Accessorial Charges

When shipping LTL using a Hatco preferred carrier, additional fees known as accessorial charges may apply and will be added to order. Residential Delivery Fee, Construction Site Delivery Fee, Government Site Delivery Fee, limited access fee are all fees added automatically by the carrier based on where the order is shipping. The fee varies depending on the service, delivery location and carrier.

Liftgate is charged by the carrier if the consignee does not have a loading dock or a forklift onsite to unload the freight from the truck. Optional services available for an additional fee include Inside Delivery, Call before Delivery and Delivery by Appointment. Hatco must be made aware of any special services needed at the time of order or prior to shipment so the fee can be added to the original invoice, otherwise the fee will be post billed and a second invoice will be received for this charge.

\*\*Fee amount varies by carrier.







# Product Index

<b>ORDER PICKUP STATIONS &amp; FOOD LOCKERS</b>	2-10
<b>WELLS</b>	11-59
<b>DECORATIVE LAMPS &amp; DISPLAY LIGHTS</b>	60-69
<b>STRIP HEATERS</b>	71-104
<b>FRY STATIONS</b>	105-110
<b>CARVING STATIONS</b>	111-113
<b>PORTABLES</b>	114-127
<b>BUILT-INS</b>	128-152

<b>DRAWER WARMERS</b>	153-158
<b>MERCHANDISERS</b>	159-181
<b>HOLDING &amp; DISPLAY CABINETS</b>	182-201
<b>TOASTERS</b>	202-208
<b>INDUCTION EQUIPMENT</b>	209-221
<b>LIGHT COOKING EQUIPMENT</b>	222-226
<b>WATER HEATING/SPECIALTY EQUIPMENT</b>	227-244

3CS	229
3CS2	230
AWD	228
C	235-236
CDW	157
CHW	19
CSBF, CSBFR, CSBFX	139-140
CSBFP	NEW 131
CSSB, CSSBR, CSSBX	136
CSSBF, CSSBFR, CSSBFX	137-138
CSSBFP	NEW 130
CSSBP	NEW 129
CSU, CSUR, CSUX	141-142
CSUP	NEW 132
CWB, CWB-S	28-30, 34
CWBP, CWBP-S	NEW 25-27
CWBR, CWBX, CWBR-S, CWBX-S	31-34
DCS	112
DHWBI, DHWBI-S	12-15
DL, DLL, DLH	NEW 61-67
F2G, F2GB	5-6
F2GP, F2GBP	7-8
FDWD-1-MN	194
FDWD	184, 187-188
FR	231
FR2	232
FS2HAC	201
FS3HAC	160-161
FSCD, FSCDH	179
FSD, FSDT	185-188
FSHAC, FSHACH	201
FSHC-5W, -7W	196
FSHC-6W	197
FSHC-7	198
FSHC-12W, -17W	199-200
FST-1-MN	194
FTB, FTB-S	37-38
FTBP, FTBP-S	NEW 35-36
FTBR, FTBR-S, FTBX, FTBX-S	39-40
FWM	223
GR2A, GR2AH	93, 95
GR2A-xxD, GR2AH-xxD	96-97
GR2AL, GR2AHL	94-95
GR2AL-xxD, GR2AHL-xxD	96-97
GR2BW	126-127
GR2S	121
GR2SDH, GR2SDS	168-169
GR3SDH, GR3SDS	173-174
GR3SDS-xxDCT, GR3SDS-xxTCT	175
GR5A, GR5AH	74, 76

GR5AL, GR5AHL	75-76
GR, GRH	78-79
GR-B	106-107
GRA, GRAH	77, 79
GRA-xxD, GRAH-xxD	80, 82
GRAL, GRAHL	78-79
GRAL-xxD, GRAHL-xxD	81-82
GRAIH, GRAIHL	90, 92
GRAIH-xxD, GRAIHL-xxD	91-92
GRAM, GRAML	83-84
GRAM-xxD	85, 87
GRAML-xxD	86-87
GRBW	126-127
GRCD, GRCDH	177-178
GRCMW	176
GRCSC, GRCSCDH	113
GRFF, GRFFL, GRFFB, GRFFBL	106-107
GRFHS, GRFS	108-109
GRHD, GRHDH	180-181
GRHW	125
GRN, GRNH	88
GRNM	89
GRPWS	163-164
GRS2G	9
GRS	119-121
GRSB	150-151
GRSBF	152
GRSDH, GRSDS	166-167
GRSDS/H	165
GRSR	116
GRSS	122
GRSSB	148
GRSSR, GRSSRxx-DL77516	117-118
HBG	123
HGBG	149
HCSBF, HCSBFR, HCSBFX	146-147
HCSSB, HCSSBR, HCSSBX	143
HCSSBF, HCSSBFR, HCSSBFX	144-145
HCWBI, HCWBIR, HCWBIX	20-21, 24
HDW	155-156
HDWTC	154
HDW-xR2	155-156
HGSM	124
HL	69
HL5	68
HRDW	158
HSBF-GL, -HC, -SS	133-135
HW	19
HWB, HWBL, HWBH	50-52, 58-59
HWB-xxQT, HWBI-xxQT	53-54, 58-59

HWBI, HWBLI	41-43, 47
HWBI43	41, 44, 47
HWBI-S	45-47
HWBRN (UR)	55-56, 58-59
HWBRT (UR)	55-56, 58-59
HWBRN-xxQT (UR)	57-59
HWBRT-xxQT (UR)	57-59
HXMH, HXMS	170, 172
HZMH, HZMS	171-172
IHDCH	189-190
IRNG-BXC1	211
IRNG-HC1, -PC1, -PB1	212-216
IRNG-PC2F, -PC2S, -PB2	217-218
IWELB	NEW 210
IWRM-C1, -CD1, -B1	219-220
IWRM-UT	221
IWB, IWB-S	22-24
ITQ	203
LFST	192
LW	115
MC	234
MDW	193
MPP	4
MPP-xPT, -xHPT	NEW 3
MPWS	110
PDH	162
PFST	195
PMG	233
PSH	162
PWB, PWC	183
RHW	17
RMB	104
RMB2	103
RWM	225
S	237-238
SAL	226
SNACK	224
SWB, SWC	NEW 16
SW2	18
TK	208
TPT	204
TQ	206-207
TQ3	NEW 205
UGA, UGAH	98, 100
UGA-xxD, UGAH-xxD	99-100
UGAL, UGAHL	98, 100
UGAL-xxD, UGAHL-xxD	99-100
UGFF, UGFFL, UGFFB, UGFFBL	106-107
WFST	191

# Paint Chip and Stone Sample Colors

## DESIGNER COLORS



## GLOSS FINISHES



## PLATED FINISHES



## SIMULATED STONE COLORS\*



## DEKTON STONE\*\* COLORS

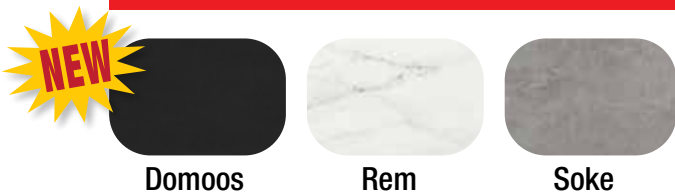

*Colors are a representation and may not exactly match our colors.  
Consult factory for possible color matching options on these colors.  
Non-standard colors are non-returnable.*

To order a Hatco Paint Chip & Stone Sample Colors Sheet, visit [www.hatcocorp.com](http://www.hatcocorp.com) / Order Literature / Sales Literature / Sell Sheets.

\* Simulated stone is Swanstone®

\*\* Due to the natural texture, patterns may vary.

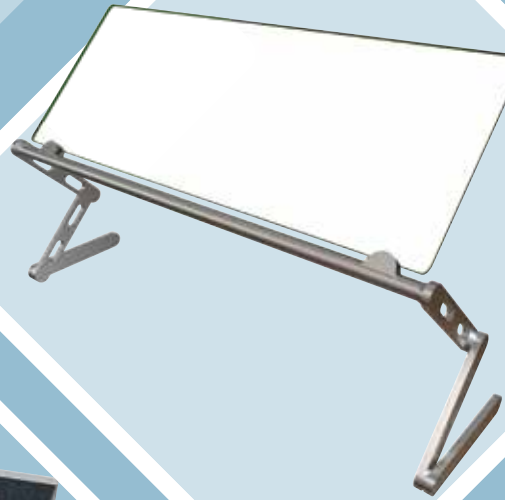

People who serve, products that solve.®

Hatco Corporation  
P.O. Box 340500 • Milwaukee, WI 53234-0500  
414-671-6350  
support@hatcocorp.com • www.hatcocorp.com  
Domestic Price List • July 1, 2024

