



Project _____
 Item # _____
 Quantity _____

Drop-In Round Heated Wells

Models:

HWB-4QT, -4QTD, -7QT, -7QTD, -11QT, -11QTD

HWBH-7QT, -7QTD, -11QT, -11QTD

Hatco Drop-In Round Heated Wells provide flexibility and quality, with many options to choose from. These units hold steam table food hot and fresh with self-adjusting thermostats that read the actual temperatures and add heat only when needed.

Standard features

- Available in 4-, 7- and 11-quart (4-, 7- and 10-liter) round wells
- Standard or high watt (4-quart [4-liter] standard watt only)
- Controls feature a separate lighted ON/OFF rocker switch and temperature dial, allowing preset temperatures to be maintained
- Available with a 50% larger drain (3/4" NPT) with flat screen simplifies cleaning and holds pans level
- Easy service access to heating elements and thermostats
- Mounting kits for combustible countertops available
- EZ locking hardware for quick installation
- Wells are designed for both WET or DRY operation
- An optional WM Control Assembly is also available that will replace most existing controls on a customer's Drop-In Heated Well unit

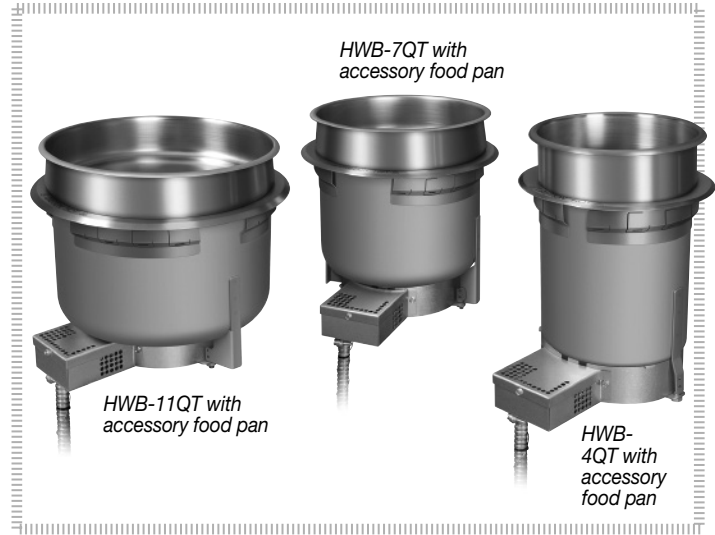

Options (available at time of purchase only)

- Additional High Temp Power Supply Lead Wire available in one foot (305 mm) increments (Lead wire only – conduit not included) (Models are shipped with 1' [305 mm] of lead wire – no conduit included)
- Thermostat with 6' (1829 mm) Capillary
- Control Box Assembly
 - Compact with Bezel (Standard [Not for export voltages])
 - Larger Recessed Thermostatic (Standard for export voltages)
 - WM Control (Not for export voltages)
 - ITC Electronic Control (Not for 4-Quart [4-liter] Round Wells)
- Control Box Bezel (Designer Colors – Nonstandard colors are non-returnable)
 - Warm Red Black Gray Granite White Granite
 - Navy Blue Hunter Green Antique Copper

Accessories

- Mounting Kit for Combustible Countertops (All Models) – no conduit
- Round Pans
 - 4-Quart (4-Liter) 7-Quart (7-Liter)
 - 11-Quart (10-Liter)
- Notched Lids
 - 4-Quart (4-Liter) 7-Quart (7-Liter)
 - 11-Quart (10-Liter)
- Hinged Lids
 - 4-Quart (4-Liter) 7-Quart (7-Liter)
 - 11-Quart (10-Liter)
- Units with Drains
 - 3/4" NPT Ball 3/4" Gate Valve
- Kit allows Mounting to Thick Countertops - 4 Brackets



HATCO CORPORATION | P.O. Box 340500 Milwaukee, WI 53234-0500 U.S.A.

(800) 558-0607 | (414) 671-6350 | www.hatcocorp.com | equipsales@hatcocorp.com | intl@hatcocorp.com



Drop-In Round Heated Wells

Models: HWB-4QT, -4QTD, -7QT, 7-QTD, 11QT, -11QTD
 HWBH-7QT, -7QTD, -11QT, -11QTD

Ordering Instructions

(Please specify the following with each order)

1. **Desired Voltage:** See chart on page 3
2. **Base Size of Heated Well:**
 - A. Round: 4-Quart (4-Liter), 7-Quart (7-Liter) or 11-Quart (10-Liter)
3. **Choose With or Without Drain**
4. **Mounting Style (Top Mounted)**
 - A. Non-Combustible Countertop
 - B. Combustible Countertop requires accessory Mounting Kit
5. **Wattage:**
 - A. High Watt
 - B. Standard Watt (4-Quart [4-Liter] available in standard watt only)

6. Agency:

- A. UL and CUL
- B. UL-EPH (sanitary listing)
- C. CE Mark available on standard and high watt units

Models HWB-4QT, HWB-7QT and HWB-11QT Series

(HWB-7QTD Shown)

HWB-4QT Series
8.25" (209 mm)
 HWB-7QT Series
10.31" (262 mm)
 HWB-11QT Series
12.31" (313 mm)

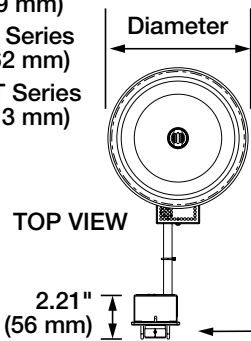

FRONT VIEW

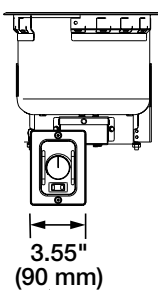

Standard Compact Thermostatic Control
(with bezel)

HWB-4QT Series
10.03" (255 mm)
 HWB-7QT Series
8.98" (228 mm)
 HWB-11QT Series
8.98" (228 mm)

SIDE VIEW

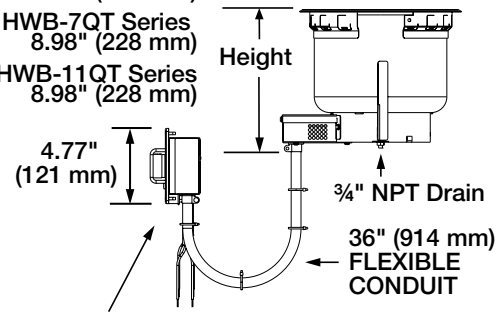

Non-Combustible
Countertop
Opening
("Circular" cut-out)

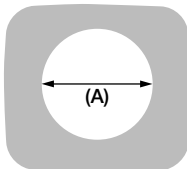

Cutout Dimensions for Non-Combustible Countertop

Model	Minimum Diameter (A)	Maximum Diameter (A)
HWB-4QT	Ø 7.125" (181 mm)	Ø 7.56" (192 mm)
HWB-7QT	Ø 9.125" (232 mm)	Ø 9.56" (243 mm)
HWB-11QT	Ø 11.125" (282 mm)	Ø 11.56" (294 mm)

Combustible
Countertop
Opening
("Square" cut-out)

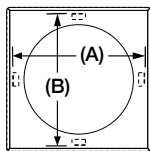

Cutout Dimensions for Combustible Countertops ▲

Model	Minimum Width (A)	Maximum Width (A)	Minimum Width (B)	Maximum Width (B)
HWB-4QT	9" (229 mm)	9.25" (235 mm)	9" (229 mm)	9.25" (235 mm)
HWB-7QT	11" (279 mm)	11.25" (286 mm)	11" (279 mm)	11.25" (286 mm)
HWB-11QT	13" (330 mm)	13.25" (337 mm)	13" (330 mm)	13.25" (337 mm)

▲ Accessory Mounting Kit required

HATCO CORPORATION | P.O. Box 340500 Milwaukee, WI 53234-0500 U.S.A.

(800) 558-0607 | (414) 671-6350 | www.hatcocorp.com | equipmentsales@hatcocorp.com | intl@hatcocorp.com



Drop-In Round Heated Wells

Models: HWB-4QT, -4QTD, -7QT, 7-QTD, 11QT, -11QTD
HWBH-7QT, -7QTD, -11QT, -11QTD

Control Boxes

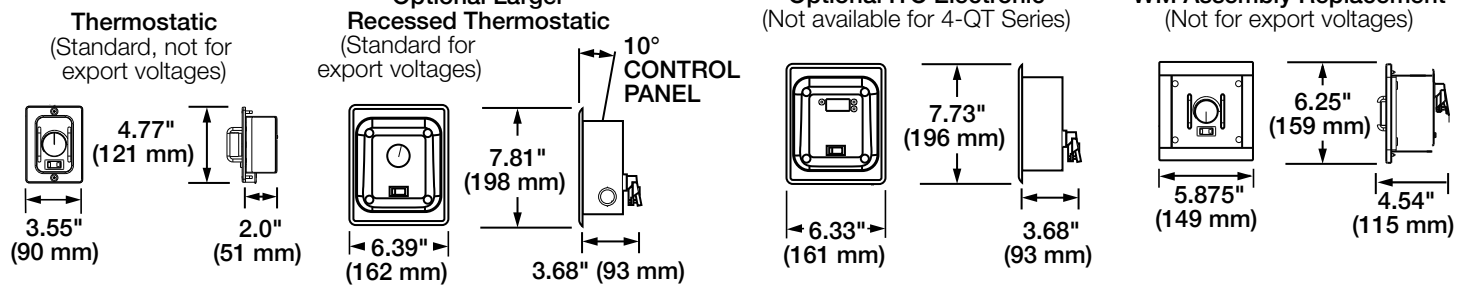

Cutout Dimensions for Control Boxes

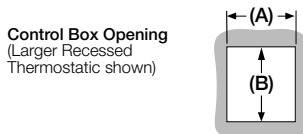

Control Box	Minimum Width (A)	Maximum Width (B)	Export Voltage
Standard Thermostatic without bezel	2.16" (55 mm)	3.375" (86 mm)	Not available
Standard Thermostatic with bezel	3.25" (83 mm)	3.75" (95 mm)	Not available
Optional Larger Recessed Thermostatic	5.875" (149 mm)	6.375" (162 mm)	Standard
Optional ITC Electronic (not available for 4-QT [4-Liter])	5.81" (148 mm)	6.27" (159 mm)	Optional
Optional WM Assembly Replacement	4.78" (121 mm)	5.00" (127 mm)	Not available

SPECIFICATIONS Drop-In Uninsulated Round Wells

The shaded areas contain electrical information for International models only

Model	Dimensions (Diameter x Height)	Volts	Phase	Watts	Amps	Control Configuration	Ship Weight*
HWB-4QT (Standard watt) HWB-4QTD* (Standard watt)	8.25" x 10.03" (209 x 255 mm)	120	Single	500	4.2	Standard: Compact Thermostatic (Not available for export voltages) Optional: WM Assembly Replacement (Not available for export voltages) or Larger Recessed Thermostatic	11 lbs. (5 kg) 10 lbs. (5 kg)
		208		536	2.6		
		240		600	2.5		
HWB-7QT (Standard watt) HWB-7QTD* (Standard watt)	10.31" x 8.98" (262 x 228 mm)	120	Single	500	4.2	Standard: Compact Thermostatic (Not available for export voltages) Optional: WM Assembly Replacement (Not available for export voltages) or Larger Recessed Thermostatic	12 lbs. (6 kg) 12 lbs. (6 kg)
		208		536	2.6		
		240		600	2.5		
HWBH-7QT (High watt) HWBH-7QTD* (High watt)	10.31" x 8.98" (262 x 228 mm)	120	Single	800	6.7	Standard: Compact Thermostatic (Not available for export voltages) Optional: WM Assembly Replacement (Not available for export voltages) ITC Electronic or Larger Recessed Thermostatic	12 lbs. (6 kg) 12 lbs. (6 kg)
		208		715	3.4		
		240		800	3.3		
HWB-11QT (Standard watt) HWB-11QTD* (Standard watt)	12.31" x 8.98" (313 x 228 mm)	120	Single	500	4.2	Standard: Compact Thermostatic (Not available for export voltages) Optional: WM Assembly Replacement (Not available for export voltages) or Larger Recessed Thermostatic	13 lbs. (6 kg) 13 lbs. (6 kg)
		208		536	2.6		
		240		600	2.5		
HWBH-11QT (High watt) HWBH-11QTD* (High watt)	12.31" x 8.98" (313 x 228 mm)	120	Single	800	6.7	Standard: Compact Thermostatic (Not available for export voltages) Optional: WM Assembly Replacement (Not available for export voltages) or Larger Recessed Thermostatic	14 lbs. (6 kg) 14 lbs. (6 kg)
		208		715	3.4		
		240		800	3.3		
		220-230 (CE)		600	2.7		
		230-240 (CE)		600	2.5		
		230-240 (CE)		800	3.3		

*"D" added to model number indicates drain equipped. * Shipping weight includes packaging.

PRODUCT SPECS Drop-In Round Heated Well

The Drop-in Round Heated Well shall be a Model ...as manufactured by the Hatco Corporation, Milwaukee, WI 53234 U.S.A.

With 24/7 parts and service assistance (U.S. and Canada only), the Drop-in Heated Well shall be rated at ...watts, ...volts, and be ...inches (millimeters) in overall

width and be ...inches (millimeters) in overall depth. It shall consist of stainless and aluminized steel housing with a metal sheathed heating element, EZ locking hardware for installation, and a remote thermostat with lighted power switch. Models with a drain consist of a 3/4" NPT drain.

Accessories may include stainless steel mounting kit and valves.

HATCO CORPORATION | P.O. Box 340500 Milwaukee, WI 53234-0500 U.S.A.

(800) 558-0607 | (414) 671-6350 | www.hatcocorp.com | equipmentsales@hatcocorp.com | intl@hatcocorp.com